

Resonances in general relativity

by

Semen Vladimirovich Dyatlov

A dissertation submitted in partial satisfaction of the
requirements for the degree of
Doctor of Philosophy

in

Mathematics

in the

Graduate Division

of the

University of California, Berkeley

Committee in charge:

Professor Maciej Zworski, Chair
Professor Daniel Tataru
Professor Robert Littlejohn

Spring 2013

Resonances in general relativity

Copyright 2013

by

Semen Vladimirovich Dyatlov

Abstract

Resonances in general relativity

by

Semen Vladimirovich Dyatlov

Doctor of Philosophy in Mathematics

University of California, Berkeley

Professor Maciej Zworski, Chair

The topic of this thesis is *a detailed study of wave decay on black hole backgrounds*, in particular the quasi-normal modes (QNMs) of black holes, known as resonances in other contexts of scattering theory.¹

Black holes are modeled in general relativity by Lorentzian manifolds (\tilde{X}, \tilde{g}) that solve vacuum Einstein's equations. We study the long-time behavior of solutions to the linear wave equation

$$\square_{\tilde{g}} u = 0, \tag{0.0.1}$$

which can be considered as the first step towards understanding the behavior of the nonlinear Einstein's equations, just like a precise understanding of linear waves on the Minkowski spacetime has lead to proving its stability with respect to Einstein's equations [24].

The particular black hole backgrounds we consider are Kerr and Kerr–de Sitter metrics, which both model rotating black holes. The difference between these two cases is the *cosmological constant* Λ , with $\Lambda = 0$ for Kerr and $\Lambda > 0$ for Kerr–de Sitter (which is the case according to the currently accepted Λ CDM cosmological model). The black hole itself is surrounded by the *event horizon*. The causal structure of the metric only allows information to cross the event horizon in the direction of the black hole. Since the energy of a solution to (0.0.1) can escape through the event horizon (as well as to spatial infinity as discussed below), one expects to see decay of the energy as time t goes to infinity.

The escape of the waves through event horizons is rapid in the sense that the corresponding escaping trajectories cross the event horizon in finite time. The Kerr metric also features an *asymptotically Euclidean infinite end*, with trajectories that take infinite time to escape. A wave concentrated on such an escaping trajectory will radiate information back to the observer at all times; because of the resulting ‘shadow’, the decay of solutions to (0.0.1) in

¹Here is an irresistible quote of Chandrasekhar “...we may expect that any initial perturbation will, during its last stages, decay in a manner characteristic of the black hole itself and independent of the cause. In other words, we may expect that during these last stages, the black hole emits gravitational waves with frequencies and rates of damping that are characteristic of the black hole itself, in the manner of a bell sounding its last dying notes.”

the Kerr case is at most *polynomial*, $\mathcal{O}(t^{-3})$ (in compact sets). See for instance [92, 31] for a detailed discussion of many recent results in this direction.

We instead concentrate our attention on the *Kerr–de Sitter* metric, whose main geometric difference from Kerr is the replacement of the spatial infinity by a *cosmological horizon*, geometrically similar to the black hole event horizon. The decay of linear waves in this case is *exponential*, $\mathcal{O}(e^{-\nu t})$. What is more, one can quantify this exponential decay in the form of a *resonance expansion* (see Theorem 2.2 for a more accurate version)

$$u(t, x) \sim \sum_{z \in \text{Res}} e^{-itz} u_z(x),$$

where z runs over a discrete set of *resonances*, or *quasi-normal modes*, $\text{Res} \subset \mathbb{C}$; this set depends only on the black hole metric, not on the solution u . The real part of z corresponds to the rate of oscillation of the corresponding wave and the (negative) imaginary part, to its rate of exponential decay in time. Quasi-normal modes have a rich history of study in the physics literature, see [79]; in this thesis, we in particular compare the numerically computed QNMs of [13] with the mathematical predictions and give a rigorous explanation to some phenomena observed recently in [134, 133, 67] (see Chapter 4).

The proof of exponential decay and the resonance expansion is done in the framework of *scattering theory*, dating back to [80]. There are two key steps:

- (1) identify the discrete set of resonances as solutions to a nonselfadjoint generalized eigenvalue problem;
- (2) understand the behavior of resonances in the *high frequency limit*

$$\text{Re } z \rightarrow \infty, \quad |\text{Im } z| \leq C.$$

The first step relies on the understanding of the infinite ends/event horizons of the metric and the low frequency contributions, while the second one depends on the geometry of the *trapped set*, consisting of light rays (geodesics) that stay in a fixed compact set away from the event horizons for all times.

The main goal of this thesis is to *understand how the geometry of the event horizons and the trapped set leads to quantitative statements about behavior of quasi-normal modes and linear waves*. The thesis consists of four chapters, which are largely independent of each other in terms of presentation; in fact, the first two chapters are similar to previously published work of the author,² and the third one has been submitted for publication.

The special case of the nonrotating *Schwarzschild–de Sitter* black hole was previously studied in [103, 17, 90]. They in particular constructed the set of resonances, proved a

²Chapter 1 is similar to the article ‘Quasi-normal modes and exponential energy decay for the Kerr–de Sitter black hole’ in *Comm. Math. Phys.* **306**(2011), pp. 119–163, and Chapter 2, to the article ‘Asymptotic distribution of quasi-normal modes for Kerr–de Sitter black holes’ in *Ann. Henri Poincaré* **13**(2012), pp. 1101–1166.

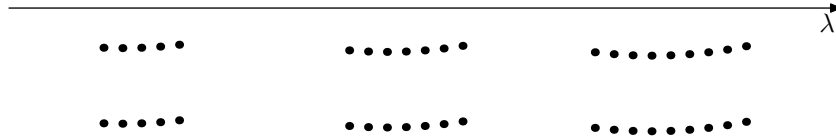

Figure 0.1: The lattice structure of QNMs in the completely integrable cases.

resonance expansion, and established a *quantization condition*, which in this situation means that resonances approximately lie on a distorted lattice in the high frequency limit – see Figure 0.1 and Theorem 2.1. These results rely on separation of variables techniques and the spherical symmetry of nonrotating black holes, splitting the problem into the *angular* component, which is just the eigenvalue problem for Laplacian on the sphere, and the *radial* component, where the scattering theory phenomena take place. In particular, *complete integrability* of the geodesic flow is crucial in establishing the quantization condition.

In Chapters 1 and 2, we generalize there results to the slowly rotating Kerr–de Sitter case. We still use separation of variables, but the analysis is made difficult by the a considerably more complicated structure of the separation of variables procedure (see §1.3) and the *ergoregion*, the region of space where the associated generalized eigenfunction problem is not elliptic. The lack of ellipticity inside the ergoregion is handled by using in a nontrivial way the analyticity of the metric (see §1.7), and the lack of self-adjointness of the angular operator, by a specially constructed Grushin problem (see §2.A).

However, an approach which does not use separation of variables techniques is ultimately more favorable; one reason is applicability of the results to small (stationary) *perturbations* of exact black hole metrics. The definition of the set of resonances (namely, step (1) above) for metrics with event horizons was done recently in [128], and the assumptions at the event horizons are stable under perturbations and formulated in geometric terms. The second part of the thesis deals with the consequences for resonances of the trapping structure of Kerr–de Sitter black holes.

The key property of the trapping is the fact that it is *normally hyperbolic*, which means that the trapped set \tilde{K} is smooth and the linearization of the geodesic flow $\tilde{\varphi}^t$ in the directions transversal to \tilde{K} exhibits hyperbolic behavior as $t \rightarrow \infty$ (see §§3.5.1, 4.2.2, 4.3.2). Normal hyperbolicity is a dynamical assumption not relying on separation of variables, and it was shown in [132] that it implies existence of a *resonance free strip* $\{\text{Im } z > -\nu\}$. Together with [128], this gives the exponential rate of decay $\mathcal{O}(e^{-\nu t})$ for solutions to (0.0.1), but does not recover information about resonances lying below the strip.

In Chapter 3, we obtain the following result on the set of resonances, presented in Figure 0.2: there are *two* resonance free strips and the resonances in between satisfy a Weyl law – the number of these resonances in a region of size R grows like cR^2 , where $c > 0$ is an explicit constant. The sizes of the strips are given in terms of naturally arising dynamical quantities $0 < \nu_{\min} \leq \nu_{\max}$, the minimal and maximal expansion rates in the directions transversal to \tilde{K} . Our result applies under a pinching condition $\nu_{\max} < 2\nu_{\min}$ and under a

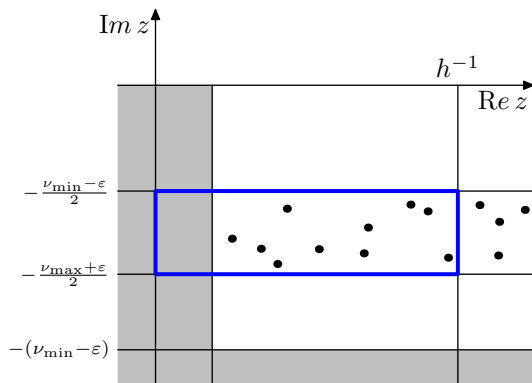

Figure 0.2: The structure of the set of resonances for r -normally hyperbolic trapping.

stronger dynamical assumption of r -normal hyperbolicity, which additionally requires that the maximal expansion rate of the flow *along* K is much smaller than ν_{\min} . This dynamical assumption is crucial for understanding the behavior of the associated solutions to (0.0.1) in phase space; moreover, unlike just normal hyperbolicity, r -normal hyperbolicity is stable under perturbations of the metric, as shown in [64] (see also §3.5.2).

Our Weyl law gives one of the very few situations in scattering theory where one has an asymptotics on the number of resonances near the real axis. We are able to deduce such asymptotics because of the presence of the second resonance free strip, and this structure in turn depends on the very fine r -normal hyperbolic structure of the trapping. This structure of the trapping is still stable under perturbations, unlike the completely integrable structure used in Chapter 2. However, the results of Chapter 2 also provide much more precise control on the location of QNMs, in the form of a quantization condition, so the two results complement each other.

The results of Chapter 3 hold under some general geometric and dynamical assumptions (§§3.4.1, 3.5.1) and that chapter makes no explicit reference to the Kerr–de Sitter metric; one reason for this is the possible applicability of the results to different settings, relating in particular to the recent work [50, 49, 51] on Ruelle resonances for contact Anosov flows – see §3.1 for details. In Chapter 4, we verify that the assumptions of Chapter 3 do indeed hold for Kerr–de Sitter metrics (with any subextremal speed of rotation) and their perturbations. Furthermore, we establish a high frequency analog of resonance expansions, decomposing a solution to the wave equation into the sum of a component with controlled decay rate and a more rapidly exponentially decaying remainder – see Theorem 4.2. The latter result in fact also applies to the Kerr metric (namely, to the case $\Lambda = 0$), giving a long time asymptotic for high frequency solutions.

Contents

Contents	i
List of Figures	iv
1 Construction of resonances for black holes	1
1.1 Introduction	1
1.2 Kerr–de Sitter metric	6
1.3 Separation of variables in an abstract setting	11
1.4 Construction of $R_g(\omega)$	17
1.5 Construction of the radial resolvent	26
1.6 Semiclassical preliminaries for radial analysis	31
1.7 Analysis near the zero energy	33
1.8 Resonance free strip	39
2 Asymptotic distribution of resonances	48
2.1 Introduction	48
2.2 Proofs of Theorems 2.1 and 2.2	52
2.2.1 Properties of the metric	52
2.2.2 Separation of variables	56
2.3 Preliminaries	61
2.3.1 Pseudodifferential operators and microlocalization	61
2.3.2 Ellipticity and formal functional calculus	65
2.3.3 Quantizing canonical transformations	67
2.3.4 Integrable systems	71
2.4 Angular problem	74
2.4.1 Outline of the proof	74
2.4.2 Hamiltonian flow	78
2.4.3 Moser averaging	81
2.4.4 Construction of the Grushin problem	83
2.5 Radial problem	87
2.5.1 Trapping	87
2.5.2 WKB solutions and the outgoing condition	88

2.5.3	Transmission through the barrier	91
2.A	Grushin problems for several commuting operators	97
2.A.1	Global Grushin problem	97
2.A.2	Local Grushin problem	101
2.A.3	Proof of Proposition 2.A.3 in the general case	103
2.B	Numerical results	106
2.B.1	Overview	106
2.B.2	Barrier-top resonances	108
2.B.3	Radial and angular quantization conditions	111
3	Resonances for r-normally hyperbolic trapping	113
3.1	Introduction	113
3.2	Outline of the argument	118
3.2.1	Ideas of the proofs and concentration of resonant states	118
3.2.2	Possible improvements	121
3.2.3	Structure of the chapter	122
3.3	Further semiclassical preliminaries	123
3.3.1	Pseudodifferential operators and microlocalization	123
3.3.2	Lagrangian distributions and Fourier integral operators	124
3.3.3	Basic estimates	126
3.4	Abstract framework near infinity	128
3.4.1	General assumptions	128
3.4.2	Some consequences of general assumptions	130
3.4.3	Example: Schrödinger operators on \mathbb{R}^n	135
3.4.4	Example: even asymptotically hyperbolic manifolds	138
3.5	r -normally hyperbolic trapped sets	140
3.5.1	Dynamical assumptions	140
3.5.2	Stability	142
3.5.3	Adapted defining functions	143
3.5.4	The canonical relation Λ°	144
3.5.5	The transport equations	145
3.6	Calculus of microlocal projectors	147
3.6.1	Model case	148
3.6.2	General case	153
3.6.3	Microlocal idempotents	157
3.6.4	Annihilating ideals	160
3.7	The projector Π	163
3.7.1	Construction of Π	163
3.7.2	Annihilating ideals	165
3.8	Resolvent estimates	166
3.8.1	Reduction to the trapped set	166
3.8.2	Estimate on the kernel of Π	169

3.8.3	Estimate on the image of Π	171
3.8.4	Microlocalization in the spectral parameter	174
3.8.5	Localization of resonant states	176
3.9	Grushin problem	178
3.10	Trace formula	184
3.11	Weyl law for resonances	187
3.A	Example of a manifold with r -normally hyperbolic trapping	189
4	Global asymptotics of waves and resonances	191
4.1	Introduction	191
4.2	General framework for linear waves	197
4.2.1	Semiclassical preliminaries	197
4.2.2	General assumptions	199
4.2.3	Reduction to the space slice	202
4.2.4	Applications to linear waves	204
4.3	Applications to Kerr(–de Sitter) metrics	212
4.3.1	General properties	212
4.3.2	Structure of the trapped set	215
4.3.3	Trapping in special cases	221
4.3.4	Results for linear waves	224
4.3.5	Results for resonances	231
4.3.6	Stability	232
	Bibliography	233

List of Figures

0.1	The lattice structure of QNMs in the completely integrable cases.	3
0.2	The structure of the set of resonances for normally hyperbolic trapping.	4
1.1	An admissible contour. The poles of R_1 are denoted by circles and the poles of R_2 are denoted by asterisks.	14
1.2	The admissible contour γ used in Proposition 1.4.4.	24
1.3	A contour with horizontal control.	37
1.4	The contour used for complex scaling.	40
1.5	Three cases for the potential \tilde{V}_0 and its Hamiltonian flow near the zero energy.	43
2.1	Interaction between radial and angular poles.	59
2.2	The joint spectrum and the set \tilde{K}	75
2.3	The potential V_0 and the intervals I_{\pm}	88
2.4	Level lines of p_0 before and after conjugation by Φ	92
2.5	Comparison of order 2 approximation to QNMs with the data of [13].	107
2.6	Left: comparison of order 2 and 4 approximations to QNMs with the data of [13]. Right: log-log plot of the error of order 1–4 approximations to QNMs, as compared to [13].	108
3.1	(a) An illustration of Theorem 3.2. (b) The canonical relation Λ°	115
3.2	(a) Assumption (11). (b) An illustration of Lemma 3.4.4.	132
3.3	(a) The graph of $f_{\theta,r}$. (b) The region where complex scaling provides meromorphic continuation of the resolvent.	136
3.4	(a) Dynamics of e^{tH_p} in the directions transverse to the trapped set. (b) Dynamics on Γ_{\pm}	141
3.5	A phase space picture of the geodesic flow near \widehat{W}	168
3.6	The contour $\partial\Omega(h)$	187
4.1	(a) The numerically computed admissible range of parameters for the subextremal Kerr–de Sitter black hole (b) An illustration of Theorem 4.3.	194
4.2	(a) Numerically computed minimal and maximal transversal expansion rates (b) A log-log plot of the relative errors of minimal/maximal imaginary parts of resonances.	195

- 4.3 The phase space picture of the flow, showing shaded $\text{WF}_h(\mathbf{u}(t))$ for (a) all t and
(b) all $t \geq t_1$, for u satisfying Definition 4.2.3. 205
- 4.4 The graphs of r and ξ_φ/τ on the trapped equators E_\pm , as functions of a for $\Lambda = 0.223$

Acknowledgments

First and foremost, I would like to thank my advisor Maciej Zworski, for suggesting the original problem, teaching the techniques of approaching it, and patiently providing me with priceless advice and inspiration. I am grateful to András Vasy for sharing with me the early versions of [128] and his interest in this project, Michael Hitrik for guiding me through the complexities of [65], Emanuele Berti and Vitor Cardoso for providing the data on quasi-normal modes used in §2.B.1, Mihalis Dafermos for many helpful discussions of general relativity and pointing me to [134, 67], and Frédéric Faure for a discussion of [50, 49, 51].

I am very thankful to Stéphane Nonnenmacher and Steve Zelditch for providing two highly valuable perspectives on applications of microlocal techniques to spectral problems, Kiril Datchev for constant mentoring and encouragement, Colin Guillarmou for an excellent tutorial on hyperbolic geometry and many highly productive conversations, Jakub Kominiarczuk for introducing me to the world of applied mathematics, and Hans Christianson, Hamid Hezari, Charles Pugh, Mihai Tohaneanu, Daniel Tataru, Tobias Schottdorf, and Amie Wilkinson for some very helpful discussions. I am also thankful to the anonymous referees of my previous papers on the subject for suggesting many improvements. Part of this work was completed while visiting École Normale Supérieure in October 2012. This research was partially supported by the NSF grants DMS-0654436 and DMS-1201417.

Finally, I would like to thank my family back home, especially my parents for encouraging me to study mathematics and my elder brother Gleb for first introducing me to microlocal analysis.

Chapter 1

Construction of resonances and exponential energy decay for Kerr–de Sitter black holes

1.1 Introduction

Quasi-normal modes are the complex frequencies appearing in expansions of waves; their real part corresponds to the rate of oscillation and the nonpositive imaginary part, to the rate of decay. According to the physics literature [79] they are expected to appear in gravitational waves caused by perturbations of black holes (for more recent references and findings, see for example [13]). In the mathematics literature they were studied by Bachelot and Motet-Bachelot [8, 9, 10] and Sá Barreto and Zworski [103], who applied the methods of scattering theory and semiclassical analysis to the case of a spherically symmetric black hole. Quasi-normal modes were described in [103] as *resonances*; that is, poles of the meromorphic continuation of a certain family of operators; it was also proved that these poles asymptotically lie on a lattice. This was further developed by Bony and Häfner in [17], who established an expansion of the solutions of the wave equation in terms of resonant states. As a byproduct of this result, they obtained exponential decay of local energy for Schwarzschild–de Sitter. Melrose, Sá Barreto, and Vasy [90] have extended this result to more general manifolds and more general initial data.

In this chapter, we employ different methods to define quasi-normal modes for the Kerr–de Sitter rotating black hole. As in [103] and [17], we use the de Sitter model; physically, this corresponds to a positive cosmological constant; mathematically, it replaces asymptotically Euclidean spatial infinity with an asymptotically hyperbolic one. Let $P_g(\omega)$, $\omega \in \mathbb{C}$, be the stationary d’Alembert–Beltrami operator of the Kerr–de Sitter metric (see §1.2 for details). It acts on functions on the space slice $X_0 = (r_-, r_+) \times \mathbb{S}^2$. We define quasi-normal modes as poles of a certain (right) inverse $R_g(\omega)$ to $P_g(\omega)$. Because of the cylindrical symmetry of the operator $P_g(\omega)$, it leaves invariant the space \mathcal{D}'_k of distributions with fixed angular momentum

$k \in \mathbb{Z}$ (with respect to the axis of rotation); the inverse $R_g(\omega)$ on \mathcal{D}'_k is constructed by

Theorem 1.1. *Let $P_g(\omega, k)$ be the restriction of $P_g(\omega)$ to \mathcal{D}'_k . Then there exists a family of operators*

$$R_g(\omega, k) : L^2_{\text{comp}}(X_0) \cap \mathcal{D}'_k \rightarrow H^2_{\text{loc}}(X_0) \cap \mathcal{D}'_k$$

meromorphic in $\omega \in \mathbb{C}$ with poles of finite rank and such that $P_g(\omega, k)R_g(\omega, k)f = f$ for each $f \in L^2_{\text{comp}}(X_0) \cap \mathcal{D}'_k$.

Since $R_g(\omega, k)$ is meromorphic, its poles, which we call k -resonances, form a discrete set. One can then say that $\omega \in \mathbb{C}$ is a resonance, or a quasi-normal mode, if ω is a k -resonance for some $k \in \mathbb{Z}$. However, it is desirable to know that resonances form a discrete subset of \mathbb{C} ; that is, k -resonances for different k do not accumulate near some point. Also, one wants to construct the inverse $R_g(\omega)$ that works for all values of k . For $\delta_r > 0$,¹ put

$$K_r = (r_- + \delta_r, r_+ - \delta_r), \quad X_K = K_r \times \mathbb{S}^2,$$

and let 1_{X_K} be the operator of multiplication by the characteristic function of X_K (which will, based on the context, act $L^2(X_K) \rightarrow L^2(X_0)$ or $L^2(X_0) \rightarrow L^2(X_K)$). Then we are able to construct $R_g(\omega)$ on X_K for a slowly rotating black hole:

Theorem 1.2. *Fix $\delta_r > 0$. Then there exists $a_0 > 0$ such that if the rotation speed of the black hole satisfies $|a| < a_0$, we have the following:*

1. *Every fixed compact set can only contain k -resonances for a finite number of values of k . Therefore, quasi-normal modes form a discrete subset of \mathbb{C} .*
2. *The operators $1_{X_K}R_g(\omega, k)1_{X_K}$ define a family of operators*

$$R_g(\omega) : L^2(X_K) \rightarrow H^2(X_K)$$

such that $P_g(\omega)R_g(\omega)f = f$ on X_K for each $f \in L^2(X_K)$ and $R_g(\omega)$ is meromorphic in $\omega \in \mathbb{C}$ with poles of finite rank.

As stated in Theorem 1.2, the operator $R_g(\omega)$ acts only on functions supported in a certain compact subset of the space slice X_0 depending on how small a is. This is due to the fact that the operator $P_g(\omega)$ is not elliptic inside the two ergospheres located near the endpoints $r = r_{\pm}$. The result above can then be viewed as a construction of $R_g(\omega)$ away from the ergospheres. However, for fixed angular momentum we are able to obtain certain boundary conditions on the elements in the image of $R_g(\omega, k)$, as well as on resonant states:

Theorem 1.3. *Let $\omega \in \mathbb{C}$.*

1. *Assume that ω is not a resonance. Take $f \in L^2_{\text{comp}}(X_0) \cap \mathcal{D}'_k$ for some $k \in \mathbb{Z}$ and put $u = R_g(\omega, k)f \in H^2_{\text{loc}}(X_0)$. Then u is outgoing in the following sense: the functions*

$$v_{\pm}(r, \theta, \varphi) = |r - r_{\pm}|^{iA_{\pm}^{-1}(1+\alpha)(r_{\pm}^2 + a^2)\omega} u(r, \theta, \varphi - A_{\pm}^{-1}(1+\alpha)a \ln |r - r_{\pm}|).$$

¹The subscript in the constants such as δ_r , C_r , C_{θ} does not mean that these constants depend on the corresponding variables, such as r or θ ; instead, it indicates that they are related to these variables.

are smooth near the event horizons $\{r_{\pm}\} \times \mathbb{S}^2$.

2. Assume that ω is a resonance. Then there exists a resonant state; i.e., a nonzero solution $u \in C^\infty(X_0)$ to the equation $P_g(\omega)u = 0$ that is outgoing in the sense of part 1.

The outgoing condition can be reformulated as follows. Consider the function $U = e^{-i\omega t}u$ on the spacetime $\mathbb{R} \times X_0$; then u is outgoing if and only if U is smooth up to the event horizons in the extension of the metric given by the Kerr-star coordinates $(t^*, r, \theta, \varphi^*)$ discussed in §1.2. This lets us establish a relation between the wave equation on Kerr-de Sitter and the family of operators $R_g(\omega)$ (Proposition 1.2.2). Note that here we do not follow earlier applications of scattering theory (including [17]), where spectral theory and in particular self-adjointness of P_g are used to define $R_g(\omega)$ for $\text{Im } \omega > 0$ and relate it to solutions of the wave equation via Stone's formula. In the situation of the present chapter, due to the lack of ellipticity of $P_g(\omega)$ inside the ergospheres, it is doubtful that P_g can be made into a self-adjoint operator; therefore, we construct $R_g(\omega)$ directly using separation of variables, cite the theory of hyperbolic equations (see §1.2) for well-posedness of the Cauchy problem for the wave equation, and prove Proposition 1.2.2 without any reference to spectral theory.

We now study the distribution of resonances in the slowly rotating Kerr-de Sitter case. First, we establish absence of nonzero resonances in the closed upper half-plane:

Theorem 1.4. *Fix $\delta_r > 0$. Then there exist constants a_0 and C such that if $|a| < a_0$, then:*

1. *There are no resonances in the upper half-plane and*

$$\|R_g(\omega)\|_{L^2(X_K) \rightarrow L^2(X_K)} \leq \frac{C}{|\text{Im } \omega|^2}, \quad \text{Im } \omega > 0.$$

2. *There are no resonances $\omega \in \mathbb{R} \setminus 0$ and*

$$R_g(\omega) = \frac{i(1 \otimes 1)}{4\pi(1 + \alpha)(r_+^2 + r_-^2 + 2a^2)\omega} + \text{Hol}(\omega),$$

where Hol stands for a family of operators holomorphic at zero.

Next, we use the methods of [132] and the fact that the only trapping in our situation is normally hyperbolic to get a resonance free strip:

Theorem 1.5. *Fix $\delta_r > 0$ and $s > 0$. Then there exist $a_0 > 0$, $\nu_0 > 0$, and C such that for $|a| < a_0$,*

$$\|R_g(\omega)\|_{L^2(X_K) \rightarrow L^2(X_K)} \leq C|\omega|^s, \quad |\text{Re } \omega| \geq C, \quad |\text{Im } \omega| \leq \nu_0.$$

Theorems 1.4 and 1.5, together with the fact that resonances form a discrete set, imply that for ν_0 small enough, zero is the only resonance in $\{\text{Im } \omega \geq -\nu_0\}$. This and the presence of the global meromorphic continuation provide exponential decay of local energy:

Theorem 1.6. *Let $(r, t^*, \theta, \varphi^*)$ be the coordinates on the Kerr–de Sitter background introduced in §1.2. Fix $\delta_r > 0$ and $s' > 0$ and assume that a is small enough. Let u be a solution to the wave equation $\square_g u = 0$ with initial data*

$$\begin{aligned} u|_{t^*=0} &= f_0 \in H^{3/2+s'}(X_0) \cap \mathcal{E}'(X_K), \\ \partial_{t^*} u|_{t^*=0} &= f_1 \in H^{1/2+s'}(X_0) \cap \mathcal{E}'(X_K). \end{aligned} \tag{1.1.1}$$

Also, define the constant

$$u_0 = \frac{1 + \alpha}{4\pi(r_+^2 + r_-^2 + 2a^2)} \int_{t^*=0} *(du).$$

Here $*$ denotes the Hodge star operator for the metric g (see §1.2). Then

$$\|u(t^*, \cdot) - u_0\|_{L^2(X_K)} \leq C e^{-\nu' t^*} (\|f_0\|_{H^{3/2+s'}(X_K)} + \|f_1\|_{H^{1/2+s'}(X_K)}), \quad t^* > 0,$$

for certain constants C and ν' independent of u .

For the Kerr metric, the local energy decay is polynomial as shown by Tataru and Tohaneanu [121, 122], see also the lecture notes by Dafermos and Rodnianski [30] and the references below.

Outline of the proof. The starting point of the construction of $R_g(\omega)$ is the separation of variables introduced by Carter. The separation of variables techniques and the related symmetries have been used in many papers, including [4, 16, 17, 41, 42, 52, 53, 103, 125]; however, these mostly consider the case of zero cosmological constant, where other difficulties occur at zero energy and a global meromorphic continuation of the type presented here is unlikely. In our case, since the metric is invariant under axial rotation, it is enough to construct the operators $R_g(\omega, k)$ and study their behavior for large k . The operator $P_g(\omega, k)$ is next decomposed into the sum of two ordinary differential operators, P_r and P_θ (see (1.2.3)). The separation of variables is discussed in §1.2; the same section contains the derivation of Theorem 1.6 from the other theorems by the complex contour deformation method.

In the Schwarzschild–de Sitter case, P_θ is just the Laplace–Beltrami operator on the round sphere and one can use spherical harmonics to reduce the problem to studying the operator $P_r + \lambda$ for large λ . In the case $a \neq 0$, however, the operator P_θ is ω -dependent; what is more, it is no longer self-adjoint unless $\omega \in \mathbb{R}$. This raises two problems with the standard implementation of separation of variables, namely decomposing L^2 into a direct sum of the eigenspaces of P_θ . Firstly, since P_θ is not self-adjoint, we cannot automatically guarantee existence of a complete system of eigenfunctions and the corresponding eigenspaces need not be orthogonal. Secondly, the eigenvalues of P_θ are functions of ω , and meromorphy of $R_g(\omega)$ is nontrivial to show when two of these eigenvalues coincide. Therefore, instead of using the eigenspace decomposition, we write $R_g(\omega)$ as a certain contour integral (1.3.1) in the complex plane; the proof of meromorphy of this integral is based on Weierstrass preparation theorem. This is described in §1.3.

In §1.4, we use the separation of variables procedure to reduce Theorems 1.1–1.4 to certain facts about the radial resolvent R_r (Proposition 1.4.2). For fixed ω, λ, k , where $\lambda \in \mathbb{C}$ is the separation constant, R_r is constructed in §1.5 using the methods of one-dimensional scattering theory. Indeed, the radial operator P_r , after the Regge–Wheeler change of variables (1.5.1), is equivalent to the Schrödinger operator $P_x = D_x^2 + V_x(x)$ for a certain potential V_x (1.5.2). (Here $x = \pm\infty$ correspond to the event horizons.) This does not, however, provide estimates on R_r that are uniform as ω, λ, k go to infinity.

The main difficulty then is proving a uniform resolvent estimate (see (1.4.8)), valid for large λ and $\operatorname{Re} \lambda \gg |\operatorname{Im} \lambda| + |\omega|^2 + |ak|^2$, which in particular guarantees the convergence of the integral (1.3.1) and Theorem 1.2. A complication arises from the fact that $V_x(\pm\infty) = -\omega_\pm^2$, where ω_\pm are proportional to $(r_\pm^2 + a^2)\omega - ak$. No matter how large ω is, one can always choose k so that one of ω_\pm is small, making it impossible to use standard complex scaling², in the case $\omega = o(k)$, due to the lack of ellipticity of the rescaled operator at infinity. To avoid this issue, we use the analyticity of V_x and semiclassical analysis to get certain control on outgoing solutions at two distant, but fixed, points (Proposition 1.7.1), and then an integration by parts argument to get an L^2 bound between these two points. This is discussed in §1.7.

Finally, §1.8 contains the proof of Theorem 1.5. We first use the results of §§1.3–1.7 to reduce the problem to scattering for the Schrödinger operator P_x in the regime $\lambda = O(\omega^2)$, $k = O(\omega)$ (Proposition 1.8.1). In this case, we apply complex scaling to deform P_x near $x = \pm\infty$ to an elliptic operator (Proposition 1.8.2). We then analyse the corresponding classical flow; it is either nontrapping at zero energy, in which case the usual escape function construction (as in, for example, [85]) applies (Proposition 1.8.3), or has a unique maximum. In the latter case we use the methods of [132] designed to handle more general normally hyperbolic trapped sets and based on commutator estimates in a slightly exotic microlocal calculus. The argument of [132] has to be modified to use complex scaling instead of an absorbing potential near infinity (see also [132, Theorem 2]).

It should be noted that, unlike [17] or [103], the construction of $R_g(\omega)$ in this chapter does not use the theorem of Mazzeo–Melrose [87] on the meromorphic continuation of the resolvent on spaces with asymptotically constant negative curvature (see also [60]). In [17] and [103], this theorem had to be applied to prove the existence of the meromorphic continuation of the resolvent for ω in a fixed neighborhood of zero where complex scaling could not be implemented.

Remark. The results of this chapter also apply if the wave equation is replaced by the Klein–Gordon equation [78]

$$(\square_g + m^2)u = 0,$$

²Complex scaling originated in mathematical physics with the work of Aguilar–Combes [1], Balslev–Combes, and Simon. It has become a standard tool in chemistry for computing resonances. A microlocal approach has been developed by Helffer–Sjöstrand, and a more geometric version by Sjöstrand–Zworski [115] — see that paper for pointers to the literature. Complex scaling was reborn in numerical analysis in 1994 as the method of “perfectly matched layers” (see [12]). A nice application of the method of complex scaling to the Schwarzschild–de Sitter case is provided in [34].

where $m > 0$ is a fixed constant. The corresponding stationary operator is $P_g(\omega) + m^2\rho^2$; when restricted to the space \mathcal{D}'_k , it is the sum of the two operators (see §1.2)

$$P_r(\omega, k; m) = P_r(\omega, k) + m^2r^2, \quad P_\theta(\omega; m) = P_\theta(\omega) + m^2a^2 \cos^2 \theta.$$

The proofs in this chapter all go through in this case as well. In particular, the rescaled radial operator P_x introduced in (1.5.2) is a Schrödinger operator with the potential

$$V_x(x; \omega, \lambda, k; m) = (\lambda + m^2r^2)\Delta_r - (1 + \alpha)^2((r^2 + a^2)\omega - ak)^2.$$

Since $V_x(\pm\infty)$ is still equal to $-\omega_\pm^2$ with ω_\pm defined in (1.5.3), the radial resolvent can be defined as a meromorphic family of operators on the entire complex plane. Also, the term $m^2r^2\Delta_r$ in the operator P_x becomes of order $O(\hbar^2)$ under the semiclassical rescaling and thus does not affect the arguments in §§1.7 and 1.8.

The only difference in the Klein–Gordon case is the absence of the resonance at zero: 1 is no longer an outgoing solution to the equation $P_x u = 0$ for $\omega = k = \lambda = 0$. Therefore, there is no u_0 term in Theorem 1.6, and all solutions to (1.1.1) decay exponentially in the compact set X_K .

1.2 Kerr–de Sitter metric

The Kerr–de Sitter metric is given by the formulas [20]

$$\begin{aligned} g = & -\rho^2 \left(\frac{dr^2}{\Delta_r} + \frac{d\theta^2}{\Delta_\theta} \right) \\ & - \frac{\Delta_\theta \sin^2 \theta}{(1 + \alpha)^2 \rho^2} (a dt - (r^2 + a^2) d\varphi)^2 \\ & + \frac{\Delta_r}{(1 + \alpha)^2 \rho^2} (dt - a \sin^2 \theta d\varphi)^2. \end{aligned}$$

Here M is the mass of the black hole, Λ is the cosmological constant (both of which we assume to be fixed), and a is the angular speed of rotation (which we assume to be bounded by some constant, and which is required to be small by most of our theorems);

$$\begin{aligned} \Delta_r &= (r^2 + a^2) \left(1 - \frac{\Lambda r^2}{3} \right) - 2Mr, \\ \Delta_\theta &= 1 + \alpha \cos^2 \theta, \\ \rho^2 &= r^2 + a^2 \cos^2 \theta, \quad \alpha = \frac{\Lambda a^2}{3}. \end{aligned}$$

We also put

$$A_\pm = \mp \partial_r \Delta_r(r_\pm) > 0.$$

The metric is defined for $\Delta_r > 0$; we assume that this happens on an open interval $0 < r_- < r < r_+ < \infty$. (For $a = 0$, this is true when $9\Lambda M^2 < 1$; it remains true if we take a small enough.) The variables $\theta \in [0, \pi]$ and $\varphi \in \mathbb{R}/2\pi\mathbb{Z}$ are the spherical coordinates on the sphere \mathbb{S}^2 . We define the space slice $X_0 = (r_-, r_+) \times \mathbb{S}^2$; then the Kerr–de Sitter metric is defined on the spacetime $\mathbb{R} \times X_0$.

The d'Alembert–Beltrami operator of g is given by

$$\begin{aligned} \square_g &= \frac{1}{\rho^2} D_r(\Delta_r D_r) + \frac{1}{\rho^2 \sin \theta} D_\theta(\Delta_\theta \sin \theta D_\theta) \\ &\quad + \frac{(1 + \alpha)^2}{\rho^2 \Delta_\theta \sin^2 \theta} (a \sin^2 \theta D_t + D_\varphi)^2 \\ &\quad - \frac{(1 + \alpha)^2}{\rho^2 \Delta_r} ((r^2 + a^2) D_t + a D_\varphi)^2. \end{aligned}$$

(Henceforth we denote $D = \frac{1}{i} \partial$.) The volume form is

$$d \text{Vol} = \frac{\rho^2 \sin \theta}{(1 + \alpha)^2} dt dr d\theta d\varphi.$$

If we replace D_t by a number $-\omega \in \mathbb{C}$, then the operator \square_g becomes equal to $P_g(\omega)/\rho^2$, where $P_g(\omega)$ is the following differential operator on X_0 :

$$\begin{aligned} P_g(\omega) &= D_r(\Delta_r D_r) - \frac{(1 + \alpha)^2}{\Delta_r} ((r^2 + a^2)\omega - a D_\varphi)^2 \\ &\quad + \frac{1}{\sin \theta} D_\theta(\Delta_\theta \sin \theta D_\theta) + \frac{(1 + \alpha)^2}{\Delta_\theta \sin^2 \theta} (a\omega \sin^2 \theta - D_\varphi)^2. \end{aligned} \tag{1.2.1}$$

We now introduce the separation of variables for the operator $P_g(\omega)$. We start with taking Fourier series in the variable φ . For every $k \in \mathbb{Z}$, define the space

$$\mathcal{D}'_k = \{u \in \mathcal{D}' \mid (D_\varphi - k)u = 0\}. \tag{1.2.2}$$

This space can be considered as a subspace of $\mathcal{D}'(X_0)$ or of $\mathcal{D}'(\mathbb{S}^2)$ alone, and

$$L^2(X_0) = \bigoplus_{k \in \mathbb{Z}} (L^2(X_0) \cap \mathcal{D}'_k);$$

the right-hand side is the Hilbert sum of a family of closed mutually orthogonal subspaces.

Let $P_g(\omega, k)$ be the restriction of $P_g(\omega)$ to \mathcal{D}'_k . Then we can write

$$P_g(\omega, k) = P_r(\omega, k) + P_\theta(\omega)|_{\mathcal{D}'_k},$$

where

$$\begin{aligned} P_r(\omega, k) &= D_r(\Delta_r D_r) - \frac{(1 + \alpha)^2}{\Delta_r} ((r^2 + a^2)\omega - ak)^2, \\ P_\theta(\omega) &= \frac{1}{\sin \theta} D_\theta(\Delta_\theta \sin \theta D_\theta) + \frac{(1 + \alpha)^2}{\Delta_\theta \sin^2 \theta} (a\omega \sin^2 \theta - D_\varphi)^2 \end{aligned} \tag{1.2.3}$$

are differential operators in r and (θ, φ) , respectively.

Next, we introduce a modification of the Kerr-star coordinates (see [30, §5.1]). Following [122], we remove the singularities at $r = r_{\pm}$ by making the change of variables $(t, r, \theta, \varphi) \rightarrow (t^*, r, \theta, \varphi^*)$, where

$$t^* = t - F_t(r), \quad \varphi^* = \varphi - F_{\varphi}(r).$$

Note that $\partial_{t^*} = \partial_t$ and $\partial_{\varphi^*} = \partial_{\varphi}$. In the new coordinates, the metric becomes

$$\begin{aligned} g = & -\rho^2 \left(\frac{dr^2}{\Delta_r} + \frac{d\theta^2}{\Delta_{\theta}} \right) \\ & - \frac{\Delta_{\theta} \sin^2 \theta}{(1 + \alpha)^2 \rho^2} [a dt^* - (r^2 + a^2) d\varphi^* + (aF'_t(r) - (r^2 + a^2)F'_{\varphi}(r)) dr]^2 \\ & + \frac{\Delta_r}{(1 + \alpha)^2 \rho^2} [dt^* - a \sin^2 \theta d\varphi^* + (F'_t(r) - a \sin^2 \theta F'_{\varphi}(r)) dr]^2. \end{aligned}$$

The functions F_t and F_{φ} are required to be smooth on (r_-, r_+) and satisfy the following conditions:

- $F_t(r) = F_{\varphi}(r) = 0$ for $r \in K_r = [r_- + \delta_r, r_+ - \delta_r]$;
- $F'_t(r) = \pm(1 + \alpha)(r^2 + a^2)/\Delta_r + F_{t\pm}(r)$ and $F'_{\varphi}(r) = \pm(1 + \alpha)a/\Delta_r + F_{\varphi\pm}(r)$, where $F_{t\pm}$ and $F_{\varphi\pm}$ are smooth at $r = r_{\pm}$, respectively;
- for some (a -independent) constant C and all $r \in (r_-, r_+)$,

$$\frac{(1 + \alpha)^2(r^2 + a^2)^2}{\Delta_r} - \Delta_r F'_t(r)^2 - (1 + \alpha)^2 a^2 \geq \frac{1}{C} > 0.$$

Under these conditions, the metric g in the new coordinates is smooth up to the event horizons $r = r_{\pm}$ and the space slices

$$X_{t_0} = \{t^* = t_0 = \text{const}\} \cap (\mathbb{R} \times X_0), \quad t_0 \in \mathbb{R},$$

are space-like. Let ν_t be the time-like normal vector field to these surfaces, chosen so that $g(\nu_t, \nu_t) = 1$ and $\langle dt^*, \nu_t \rangle > 0$.

We now establish a basic energy estimate for the wave equation in our setting. Let u be a real-valued function smooth in the coordinates $(t^*, r, \theta, \varphi^*)$ up to the event horizons. Define the vector field $T(du)$ by

$$T(du) = \partial_t u \nabla_g u - \frac{1}{2} g(du, du) \nu_t.$$

Since ν_t is timelike, the expression $g(T(du), \nu_t)$ is a positive definite quadratic form in du . For $t_0 \in \mathbb{R}$, define $E(t_0)(du)$ as the integral of this quadratic form over the space slice X_{t_0} with the volume form induced by the metric.

Proposition 1.2.1. *Take $t_1 < t_2$ and let*

$$\Omega = \{t_1 \leq t^* \leq t_2\} \times X_0.$$

Assume that u is smooth in Ω up to its boundary and solves the wave equation $\square_g u = 0$ in this region. Then

$$E(t_2)(du) \leq e^{C_e(t_2-t_1)} E(t_1)(du)$$

for some constant C_e independent of t_1 and t_2 .

Proof. We use the method of [123, Proposition 2.8.1]. We apply the divergence theorem to the vector field $T(du)$ on the domain Ω . The integrals over X_{t_1} and X_{t_2} will be equal to $-E(t_1)$ and $E(t_2)$. The restriction of the metric to tangent spaces of the event horizons is nonpositive and the field ν_t is pointing outside of Ω at $r = r_{\pm}$; therefore, the integrals over the event horizons will be nonnegative. Finally, since $\square_g u = 0$, one can prove that $\operatorname{div} T(du)$ is quadratic in du and thus

$$|\operatorname{div} T(du)| \leq Cg(T(du), \nu_t).$$

Therefore, the divergence theorem gives

$$E(t_2) - E(t_1) \leq C \int_{t_1}^{t_2} E(t_0) dt_0.$$

It remains to use Gronwall's inequality. □

The geometric configuration of $\{t^* = t_1\}$, $\{t^* = t_2\}$, $\{r = r_{\pm}\}$, and ν_t with respect to the Lorentzian metric g used in Proposition 1.2.1, combined with the theory of hyperbolic equations (see [30, Proposition 3.1.1], [71, Theorem 23.2.4], or [123, §§2.8 and 7.7]), makes it possible to prove that for each $f_0 \in H^1(X_0)$, $f_1 \in L^2(X_0)$, there exists a unique solution

$$u(t^*, \cdot) \in C([0, \infty); H^1(X_0)) \cap C^1([0, \infty); L^2(X_0))$$

to the initial value problem

$$\square_g u = 0, \quad u|_{t^*=0} = f_0, \quad \partial_{t^*} u|_{t^*=0} = f_1. \tag{1.2.4}$$

We are now ready to prove Theorem 1.6. Fix $\delta_r > 0$ and assume that a is chosen small enough so that Theorems 1.2–1.5 hold. Assume that $s' > 0$ and u is the solution to (1.2.4) with $f_0 \in H^{3/2+s'} \cap \mathcal{E}'(X'_K)$ and $f_1 \in H^{1/2+s'} \cap \mathcal{E}'(X'_K)$, where X'_K is fixed and compactly contained in X_K . By finite propagation speed (see [123, Theorem 2.6.1 and §2.8]), there exists a function $\chi(t) \in C^\infty(0, \infty)$ independent of u and such that $\chi(t^*) = 1$ for $t^* > 1$, and for $t^* \in \operatorname{supp}(1 - \chi)$, $\operatorname{supp} u(t^*, \cdot) \subset X_K$. By Proposition 1.2.1, we can define the Fourier-Laplace transform

$$\widehat{\chi u}(\omega) = \int e^{it^*\omega} \chi(t^*) u(t^*, \cdot) dt^* \in H^{3/2+s'}(X_0), \quad \operatorname{Im} \omega > C_e.$$

Put $f = \rho^2 \square_g(\chi u) = \rho^2[\square_g, \chi]u$; then

$$f \in H_{\text{comp}}^{1/2+s'}(\mathbb{R}; L^2(X_0) \cap \mathcal{E}'(X_K)).$$

Therefore, one can define the Fourier-Laplace transform $\hat{f}(\omega) \in L^2 \cap \mathcal{E}'(X_K)$ for all $\omega \in \mathbb{C}$, and we have the estimate

$$\int \langle \omega \rangle^{2s'+1} \|\hat{f}(\omega)\|_{L^2(X_0)}^2 d\omega \leq C(\|f_0\|_{H^{3/2+s'}}^2 + \|f_1\|_{H^{1/2+s'}}^2).$$

where integration is performed over the line $\{\text{Im } \omega = \nu = \text{const}\}$ with ν bounded.

Proposition 1.2.2. *We have for $\text{Im } \omega > C_e$,*

$$\widehat{\chi u}(\omega)|_{X_K} = R_g(\omega)\hat{f}(\omega).$$

Proof. Without loss of generality, we may assume that $u \in C^\infty \cap \mathcal{D}'_k$ for some $k \in \mathbb{Z}$; then $R_g(\omega)\hat{f}(\omega)$ can be defined on the whole X_0 by Theorem 1.1. Fix ω and put

$$\Phi(\omega) = e^{i\omega F_t(r)} \widehat{\chi u}(\omega) - R_g(\omega, k)\hat{f}(\omega) \in C^\infty(X_0).$$

Since $\rho^2 \square_g(\chi u) = f$, we have

$$P_g(\omega)(e^{i\omega F_t(r)} \widehat{\chi u}(\omega)) = \hat{f}(\omega);$$

therefore, $P_g(\omega)\Phi(\omega) = 0$. Note also that Φ is smooth inside X_0 because of ellipticity of the operator $P_g(\omega)$ on \mathcal{D}'_k (see [123, §7.4] and the last step of the proof of Theorem 1.1). Now, if we put

$$U(t, \cdot) = e^{-it\omega} \Phi(\omega)(\cdot),$$

then $\square_g U = 0$ inside X_0 . However, by Theorem 1.3, U is smooth in the $(r, t^*, \theta, \varphi^*)$ coordinates up to the event horizons and its energy grows in time faster than allowed by Proposition 1.2.1; therefore, $\Phi = 0$. \square

We now restrict our attention to the compact X_K , where in particular $t = t^*$ and $\varphi = \varphi^*$. By the Fourier Inversion Formula, for $t > 1$ and $\nu > C_e$,

$$u(t)|_{X_K} = (2\pi)^{-1} \int e^{-it(\omega+i\nu)} R_g(\omega+i\nu)\hat{f}(\omega+i\nu) d\omega.$$

Fix positive $s < s'$. By Theorems 1.4 and 1.5, there exists $\nu_0 > 0$ such that zero is the only resonance with $\text{Im } \omega \geq -\nu_0$. Using the estimates in these theorems, we can deform the contour of integration above to the one with $\nu = -\nu_0$. Indeed, by a density argument we may assume that $u \in C^\infty$, and in this case, $\hat{f}(\omega)$ is rapidly decreasing as $\text{Re } \omega \rightarrow \infty$ for $\text{Im } \omega$ fixed. We then get

$$\begin{aligned} u(t)|_{K_r} &= \frac{1+\alpha}{4\pi(r_+^2 + r_-^2 + 2a^2)} (\hat{f}(0), 1)_{L^2(K_r)} \\ &+ (2\pi)^{-1} e^{-\nu_0 t} \int e^{-it\omega} R_g(\omega - i\nu_0)\hat{f}(\omega - i\nu_0) d\omega. \end{aligned} \tag{1.2.5}$$

We find a representation of the first term above in terms of the initial data for u at time zero. We have

$$(\hat{f}(0), 1)_{L^2(K_r)} = \int_{X_K \times \mathbb{R}} \square_g(\chi u) d\text{Vol}.$$

Here $d\text{Vol}$ is the volume form induced by g . Integrating by parts, we get

$$\int_{X_K \times \mathbb{R}} \square_g(\chi u) d\text{Vol} = - \int_{t \geq 0} \square_g((1 - \chi)u) d\text{Vol} = \int_{t=0} *(du). \quad (1.2.6)$$

Here $*$ is the Hodge star operator induced by the metric g , with the orientation on X_0 and $\mathbb{R} \times X_0$ chosen so that $*(dt)$ is positively oriented on $\{t = 0\}$.

Finally, the L^2 norm of the integral term in (1.2.5) can be estimated by

$$\begin{aligned} & C e^{-\nu_0 t} \int \langle \omega \rangle^{s-s'-1/2} \| \langle \omega \rangle^{s'+1/2} \hat{f}(\omega - i\nu_0) \|_{L^2(K_r)} d\omega \\ & \leq C e^{-\nu_0 t} \| \langle \omega \rangle^{s'+1/2} \hat{f}(\omega - i\nu_0) \|_{L^2_{\omega}(\mathbb{R})L^2(K_r)} \\ & \leq C e^{-\nu_0 t} (\|f_0\|_{H^{s'+3/2}} + \|f_1\|_{H^{s'+1/2}}), \end{aligned}$$

since $\langle \omega \rangle^{s-s'-1/2} \in L^2$. This proves Theorem 1.6.

Remark. In the original coordinates, (t, r, θ, φ) , the equation $\square_g u = 0$ has two solutions depending only on the time variable, namely, $u = 1$ and $u = t$. Even though Theorem 1.6 does not apply to these solutions because we only construct the family of operators $R_g(\omega)$ acting on functions on the compact set X_K , it is still interesting to see where our argument fails if $R_g(\omega)$ were well-defined on the whole X_0 . The key fact is that our Cauchy problem is formulated in the t^* variable. Then, for $u = t$ the function $f_0 = u|_{t^*=0}$ behaves like $\log|r - r_{\pm}|$ near the event horizons and thus does not lie in the energy space H^1 . As for $u = 1$, our theorem gives the correct form of the contribution of the zero resonance, namely, a constant; however, the value of this constant cannot be given by the integral of $*(du)$ over $t^* = 0$, as $du = 0$. This discrepancy is explained if we look closer at the last equation in (1.2.6); while integrating by parts, we will get a nonzero term coming from the integral of $*d(\chi(t^*))$ over the event horizons.

1.3 Separation of variables in an abstract setting

In this section, we construct inverses for certain families of operators with separating variables. Since the method described below can potentially be applied to other situations, we develop it abstractly, without any reference to the operators of our problem. Similar constructions have been used in other settings by Ben-Artzi–Devinatz [11] and Mazzeo–Vasy [88, §2].

First, let us consider a differential operator

$$P(\omega) = P_1(\omega) + P_2(\omega)$$

in the variables (x_1, x_2) , where $P_1(\omega)$ is a differential operator in the variable x_1 and $P_2(\omega)$ is a differential operator in the variable x_2 ; ω is a complex parameter. If we take \mathcal{H}_1 and \mathcal{H}_2 to be certain L^2 spaces in the variables x_1 and x_2 , respectively, then the corresponding L^2 space in the variables (x_1, x_2) is their Hilbert tensor product $\mathcal{H} = \mathcal{H}_1 \otimes \mathcal{H}_2$. Recall that for any two bounded operators A_1 and A_2 on \mathcal{H}_1 and \mathcal{H}_2 , respectively, their tensor product $A_1 \otimes A_2$ is a bounded operator on \mathcal{H} and

$$\|A_1 \otimes A_2\| = \|A_1\| \cdot \|A_2\|.$$

The operator P is now written on \mathcal{H} as

$$P(\omega) = P_1(\omega) \otimes 1_{\mathcal{H}_2} + 1_{\mathcal{H}_1} \otimes P_2(\omega).$$

We now wish to construct an inverse to $P(\omega)$. The method used is an infinite-dimensional generalization of the following elementary

Proposition 1.3.1. *Assume that A and B are two (finite-dimensional) matrices and that the matrix $A \otimes 1 + 1 \otimes B$ is invertible. (That is, no eigenvalue of A is the negative of an eigenvalue of B .) For $\lambda \in \mathbb{C}$, let $R_A(\lambda) = (A + \lambda)^{-1}$ and $R_B(\lambda) = (B - \lambda)^{-1}$. Take γ to be a bounded simple closed contour in the complex plane such that all poles of R_A lie outside of γ , but all poles of R_B lie inside γ ; we assume that γ is oriented in the clockwise direction. Then*

$$(A \otimes 1 + 1 \otimes B)^{-1} = \frac{1}{2\pi i} \int_{\gamma} R_A(\lambda) \otimes R_B(\lambda) d\lambda.$$

The starting point of the method are the inverses³

$$R_1(\omega, \lambda) = (P_1(\omega) + \lambda)^{-1}, \quad R_2(\omega, \lambda) = (P_2(\omega) - \lambda)^{-1}$$

defined for $\lambda \in \mathbb{C}$. These inverses depend on two complex variables, and we need to specify their behavior near the singular points:

Definition 1.3.2. *Let \mathcal{X} be any Banach space, and let W be a domain in \mathbb{C}^2 . We say that $T(\omega, \lambda)$ is an (ω -nondegenerate) meromorphic map $W \rightarrow \mathcal{X}$ if:*

- (1) $T(\omega, \lambda)$ is a (norm) holomorphic function of two complex variables with values in \mathcal{X} for $(\omega, \lambda) \notin Z$, where Z is a closed subset of W , called the divisor of T ,
- (2) for each $(\omega_0, \lambda_0) \in Z$, we can write $T(\omega, \lambda) = S(\omega, \lambda)/X(\omega, \lambda)$ near (ω_0, λ_0) , where S is holomorphic with values in \mathcal{X} and X is a holomorphic function of two variables (with values in \mathbb{C}) such that:

³In this section, we do not use the fact that $R_j(\omega, \lambda) = (P_j(\omega) \pm \lambda)^{-1}$, neither do we prove that $R(\omega) = P(\omega)^{-1}$. This step will be done in our particular case in the proof of Theorem 1.1 in the next section; in fact, R_1 will only be a right inverse to $P_1 + \lambda$. Until then, we merely establish properties of $R(\omega)$ defined by (1.3.1) below.

- for each ω close to ω_0 , there exists λ such that $X(\omega, \lambda) \neq 0$, and
- the divisor of T is given by $\{X = 0\}$ near (ω_0, λ_0) .

Note that the definition above is stronger than the standard definition of meromorphy and it is not symmetric in ω and λ . Henceforth we will use this definition when talking about meromorphic families of operators of two complex variables. It is clear that any derivative (in ω and/or λ) of a meromorphic family is again meromorphic. Moreover, if $T(\omega, \lambda)$ is meromorphic and we fix ω , then T is a meromorphic family in λ .

If \mathcal{X} is the space of all bounded operators on some Hilbert space (equipped with the operator norm), then it makes sense to talk about having poles of finite rank:

Definition 1.3.3. *Let \mathcal{H} be a Hilbert space and let $T(\omega, \lambda)$ be a meromorphic family of operators on \mathcal{H} in the sense of Definition 1.3.2. For (ω_0, λ_0) in the divisor of T , consider the decomposition*

$$T(\omega_0, \lambda) = T_H(\lambda) + \sum_{j=1}^N \frac{T_j}{(\lambda - \lambda_0)^j}.$$

Here T_H is holomorphic near λ_0 and T_j are some operators. We say that T has poles of finite rank if every operator T_j in the above decomposition of every ω -derivative of T near every point in the divisor is finite-dimensional.

One can construct meromorphic families of operators with poles of finite rank by using the following generalization of Analytic Fredholm Theory:

Proposition 1.3.4. *Assume that $T(\omega, \lambda) : \mathcal{H}_1 \rightarrow \mathcal{H}_2$, $(\omega, \lambda) \in \mathbb{C}^2$, is a holomorphic family of Fredholm operators, where \mathcal{H}_1 and \mathcal{H}_2 are some Hilbert spaces. Moreover, assume that for each ω , there exists λ such that the operator $T(\omega, \lambda)$ is invertible. Then $T(\omega, \lambda)^{-1}$ is a meromorphic family of operators $\mathcal{H}_2 \rightarrow \mathcal{H}_1$ with poles of finite rank. (The divisor is the set of all points where T is not invertible.)*

Proof. We can use the proof of the standard Analytic Fredholm Theory via Grushin problems, see for example [137, Theorem C.3]. \square

We now go back to constructing the inverse to $P(\omega)$. We assume that

- (A) $R_j(\omega, \lambda)$, $j = 1, 2$, are two families of bounded operators on \mathcal{H}_j with poles of finite rank. Here ω lies in a domain $\Omega \subset \mathbb{C}$ and $\lambda \in \mathbb{C}$.

We want to integrate the tensor product $R_1 \otimes R_2$ in λ over a contour γ that separates the sets of poles of $R_1(\omega, \cdot)$ and $R_2(\omega, \cdot)$. Let Z_j be the divisor of R_j . We call a point ω *regular* if the sets $Z_1(\omega)$ and $Z_2(\omega)$ given by

$$Z_j(\omega) = \{\lambda \in \mathbb{C} \mid (\omega, \lambda) \in Z_j\}$$

do not intersect. The behavior of the contour γ at infinity is given by the following

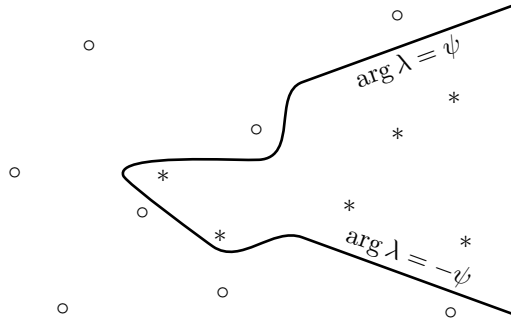

Figure 1.1: An admissible contour. The poles of R_1 are denoted by circles and the poles of R_2 are denoted by asterisks.

Definition 1.3.5. Let $\psi \in (0, \pi)$ be a fixed angle, and let ω be a regular point. A smooth simple contour γ on \mathbb{C} is called admissible (at ω) if:

- outside of some compact subset of \mathbb{C} , γ is given by the rays $\arg \lambda = \pm\psi$, and
- γ separates \mathbb{C} into two regions, Γ_1 and Γ_2 , such that sufficiently large positive real numbers lie in Γ_2 , and $Z_j(\omega) \subset \Gamma_j$ for $j = 1, 2$.

(Henceforth, we assume that $\arg \lambda \in [-\pi, \pi]$. The contour γ and the regions Γ_j are allowed to have several connected components.)

Existence of admissible contours and convergence of the integral is guaranteed by the following condition:

- (B) For any compact $K_\omega \subset \Omega$, there exist constants C and R such that for $\omega \in K_\omega$ and $|\lambda| \geq R$,
- for $|\arg \lambda| \leq \psi$, we have $(\omega, \lambda) \notin Z_1$ and $\|R_1(\omega, \lambda)\| \leq C/|\lambda|$, and
 - for $|\arg \lambda| \geq \psi$, we have $(\omega, \lambda) \notin Z_2$ and $\|R_2(\omega, \lambda)\| \leq C/|\lambda|$.

It follows from (B) that there exist admissible contours at every regular point. Take a regular point ω , an admissible contour γ at ω , and define

$$R(\omega) = \frac{1}{2\pi i} \int_{\gamma} R_1(\omega, \lambda) \otimes R_2(\omega, \lambda) d\lambda. \quad (1.3.1)$$

Here the orientation of γ is chosen so that Γ_1 always stays on the left. The integral above converges and is independent of the choice of an admissible contour γ . Moreover, the set of regular points is open and R is holomorphic on this set. (We may represent $R(\omega)$ as a locally uniform limit of the integral over the intersection of γ with a ball whose radius goes to infinity.)

The main result of this section is

Proposition 1.3.6. *Assume that \mathcal{H}_1 and \mathcal{H}_2 are two Hilbert spaces, and $\mathcal{H} = \mathcal{H}_1 \otimes \mathcal{H}_2$ is their Hilbert tensor product. Let $R_1(\omega, \lambda)$ and $R_2(\omega, \lambda)$ be two families of bounded operators on \mathcal{H}_1 and \mathcal{H}_2 , respectively, for $\omega \in \Omega \subset \mathbb{C}$ and $\lambda \in \mathbb{C}$. Assume that R_1 and R_2 satisfy assumptions (A)–(B) and the nondegeneracy assumption*

(C) *The set Ω_R of all regular points is nonempty.*

Then the set of all non-regular points is discrete and the operator $R(\omega)$ defined by (1.3.1) is meromorphic in $\omega \in \Omega$ with poles of finite rank.

The rest of this section contains the proof of Proposition 1.3.6. First, let us establish a normal form for meromorphic decompositions of families in two variables:

Proposition 1.3.7. *Let $T(\omega, \lambda)$ be meromorphic (with values in some Banach space) and assume that (ω_0, λ_0) lies in the divisor of T . Then we can write near (ω_0, λ_0)*

$$T(\omega, \lambda) = \frac{S(\omega, \lambda)}{Q(\omega, \lambda)},$$

where S is holomorphic and Q is a monic polynomial in λ of degree N and coefficients holomorphic in ω ; moreover, $Q(\omega_0, \lambda) = (\lambda - \lambda_0)^N$. The divisor of T coincides with the set of zeroes of Q near (ω_0, λ_0) .

Proof. Follows from Definition 1.3.2 and Weierstrass Preparation Theorem. \square

Proposition 1.3.8. *Assume that $Q_j(\omega, \lambda)$, $j = 1, 2$, are two monic polynomials in λ of degrees N_j with coefficients holomorphic in ω near ω_0 . Assume also that for some ω , Q_1 and Q_2 are coprime as polynomials. Then there exist unique polynomials p_1 and p_2 of degree no more than $N_2 - 1$ and $N_1 - 1$, respectively, with coefficients meromorphic in ω and such that*

$$1 = p_1 Q_1 + p_2 Q_2$$

when p_1 and p_2 are well-defined.

Proof. The $N_1 + N_2$ coefficients of p_1 and p_2 solve a system of $N_1 + N_2$ linear equations with fixed right-hand side and the matrix $A(\omega)$ depending holomorphically on ω . If ω is chosen so that Q_1 and Q_2 are coprime, then the system has a unique solution; therefore, the determinant of $A(\omega)$ is not identically zero. The proposition then follows from Cramer's Rule. \square

We are now ready to prove that $R(\omega)$ is meromorphic. It suffices to show that for each $\omega_0 \notin \Omega_R$ lying in the closure $\overline{\Omega_R}$, ω_0 is an isolated non-regular point and $R(\omega)$ has a meromorphic decomposition at ω_0 with finite-dimensional principal part. Indeed, in this case $\overline{\Omega_R}$ is open; since it is closed and nonempty by (C), we have $\overline{\Omega_R} = \Omega$ and the statement above applies to each ω_0 .

Let $Z_1(\omega_0) \cap Z_2(\omega_0) = \{\lambda_1, \dots, \lambda_m\}$. We choose a ball Ω_0 centered at ω_0 and disjoint balls U_l centered at λ_l such that:

- for $\omega \in \Omega_0$, the set $Z_1(\omega) \cap Z_2(\omega)$ is covered by balls U_l and the set $Z_1(\omega) \cup Z_2(\omega)$ does not intersect the circles ∂U_l ;
- for $\omega \in \Omega_0$ and $\lambda \in U_l$, we have $R_j = S_{jl}/Q_{jl}$, where S_{jl} are holomorphic and Q_{jl} are monic polynomials in λ of degree N_{jl} with coefficients holomorphic in ω , and $Q_{jl}(\omega_0, \lambda) = (\lambda - \lambda_l)^{N_{jl}}$;
- for $\omega \in \Omega_0$, the set of all roots of $Q_{jl}(\omega, \cdot)$ coincides with $Z_j(\omega) \cap U_l$;
- there exists a contour γ_0 that does not intersect any U_l and is admissible for any $\omega \in \Omega_0$ with respect to the sets $Z_j(\omega) \setminus \cup U_l$ in place of $Z_j(\omega)$; moreover, each ∂U_l lies in the region Γ_1 with respect to γ_0 (see Definition 1.3.5).

Let us assume that $\omega \in \Omega_0$ is regular. (Such points exist since ω_0 lies in the closure of Ω_R .) For every l , the polynomials $Q_{1l}(\omega, \lambda)$ and $Q_{2l}(\omega, \lambda)$ are coprime; we find by Proposition 1.3.8 unique polynomials $p_{1l}(\omega, \lambda)$ and $p_{2l}(\omega, \lambda)$ such that

$$1 = p_{1l}Q_{1l} + p_{2l}Q_{2l}$$

and $\deg p_{1l} < N_{2l}$, $\deg p_{2l} < N_{1l}$. The converse is also true: if all coefficients of p_{1l} and p_{2l} are holomorphic at some point ω for all l , then ω is a regular point. It follows immediately that ω_0 is an isolated non-regular point.

To obtain the meromorphic expansion of $R(\omega)$ near ω_0 , let us take a regular point $\omega \in \Omega_0$ and an admissible contour $\gamma = \gamma_0 + \dots + \gamma_m$, where γ_0 is the ω -independent contour defined above and each γ_l is a contour lying in U_l . The integral over γ_0 is holomorphic near ω_0 , while

$$\begin{aligned} & \int_{\gamma} R_1(\omega, \lambda) \otimes R_2(\omega, \lambda) d\lambda \\ &= \int_{\gamma} S_{1l}(\omega, \lambda) \otimes S_{2l}(\omega, \lambda) \left(\frac{p_{1l}(\omega, \lambda)}{Q_{2l}(\omega, \lambda)} + \frac{p_{2l}(\omega, \lambda)}{Q_{1l}(\omega, \lambda)} \right) d\lambda \\ &= \int_{\partial U_l} p_{1l} S_{1l} \otimes R_2 d\lambda = \sum_{j=0}^{N_{2l}-1} p_{1lj}(\omega) \int_{\partial U_l} (\lambda - \lambda_l)^j S_{1l} \otimes R_2 d\lambda. \end{aligned}$$

Here $p_{1lj}(\omega)$ are the coefficients of p_{1l} as a polynomial of $\lambda - \lambda_l$; they are meromorphic in ω and the rest is holomorphic in $\omega \in \Omega_0$.

It remains to prove that R has poles of finite rank. It suffices to show that every derivative in ω of the last integral above at $\omega = \omega_0$ has finite rank. Each of these, in turn, is a finite linear combination of

$$\int_{\partial U_l} (\lambda - \lambda_l)^j \partial_{\omega}^a S_{1l}(\omega_0, \lambda) \otimes \partial_{\omega}^b R_2(\omega_0, \lambda) d\lambda.$$

However, since $\partial_{\omega}^a S_{1l}(\omega_0, \lambda)$ is holomorphic in $\lambda \in U_l$, only the principal part of the Laurent decomposition of $\partial_{\omega}^b R_2(\omega_0, \lambda)$ at $\lambda = \lambda_l$ will contribute to this integral; therefore, the image

of each operator in the principal part of Laurent decomposition of $R(\omega)$ at ω_0 lies in $\mathcal{H}_1 \otimes V_2$, where V_2 is a certain finite-dimensional subspace of \mathcal{H}_2 . It remains to show that each of these images also lies in $V_1 \otimes \mathcal{H}_2$, where V_1 is a certain finite-dimensional subspace of \mathcal{H}_1 . This is done by the same argument, using the fact that

$$\int_{\partial U_l - \gamma_l} R_1(\omega, \lambda) \otimes R_2(\omega, \lambda) d\lambda$$

can be written in terms of p_{2l} and $R_1 \otimes S_{2l}$ and the integral over ∂U_l is holomorphic at ω_0 . The proof of Proposition 1.3.6 is finished.

1.4 Construction of $R_g(\omega)$

As we saw in the previous section, one can deduce the existence of an inverse to $P_g = P_r + P_\theta$ and its properties from certain properties of the inverses to $P_r + \lambda$ and $P_\theta - \lambda$ for $\lambda \in \mathbb{C}$. We start with the latter. For $a = 0$, P_θ is the (negative) Laplace–Beltrami operator for the round metric on \mathbb{S}^2 ; therefore, its eigenvalues are given by $\lambda = l(l+1)$ for $l \in \mathbb{Z}$, $l \geq 0$. Moreover, if \mathcal{D}'_k is the space defined in (1.2.2) and there is an eigenfunction of $P_\theta|_{\mathcal{D}'_k}$ with eigenvalue $l(l+1)$, then $l \geq k$. These observations can be generalized to our case:

Proposition 1.4.1. *There exists a two-sided inverse*

$$R_\theta(\omega, \lambda) = (P_\theta(\omega) - \lambda)^{-1} : L^2(\mathbb{S}^2) \rightarrow H^2(\mathbb{S}^2), \quad (\omega, \lambda) \in \mathbb{C}^2,$$

with the following properties:

1. $R_\theta(\omega, \lambda)$ is meromorphic with poles of finite rank in the sense of Definition 1.3.3 and it has the following meromorphic decomposition at $\omega = \lambda = 0$:

$$R_\theta(\omega, \lambda) = \frac{S_{\theta 0}(\omega, \lambda)}{\lambda - \lambda_\theta(\omega)} \tag{1.4.1}$$

where $S_{\theta 0}$ and λ_θ are holomorphic in a -independent neighborhoods of zero and

$$S_{\theta 0}(0, 0) = -\frac{1 \otimes 1}{4\pi}, \quad \lambda_\theta(\omega) = O(|\omega|^2).$$

2. There exists a constant C_θ such that

$$\|R_\theta(\omega, \lambda)\|_{L^2(\mathbb{S}^2) \cap \mathcal{D}'_k \rightarrow L^2(\mathbb{S}^2)} \leq \frac{C_\theta}{|k|^2} \text{ for } |\lambda| \leq k^2/2, \quad |k| \geq C_\theta |a\omega|. \tag{1.4.2}$$

and

$$\|R_\theta(\omega, \lambda)\|_{L^2(\mathbb{S}^2) \cap \mathcal{D}'_k \rightarrow L^2(\mathbb{S}^2)} \leq \frac{2}{|\operatorname{Im} \lambda|} \tag{1.4.3}$$

for $|\operatorname{Im} \lambda| > C_\theta |a| (|a\omega| + |k|) |\operatorname{Im} \omega|$.

3. For every $\psi > 0$, there exists a constant C_ψ such that

$$\|R_\theta(\omega, \lambda)\|_{L^2(\mathbb{S}^2) \rightarrow L^2(\mathbb{S}^2)} \leq \frac{C_\psi}{|\lambda|} \text{ for } |\arg \lambda| \geq \psi, \quad |\lambda| \geq C_\psi |a\omega|^2. \quad (1.4.4)$$

Proof. 1. Recall (1.2.3) that $P_\theta(\omega)$ is a holomorphic family of elliptic second order differential operators on the sphere. Therefore, for each λ , the operator $P_\theta(\omega) - \lambda : H^2(\mathbb{S}^2) \rightarrow L^2(\mathbb{S}^2)$ is Fredholm (see for example [123, §7.10]). By Proposition 1.3.4, $R_\theta(\omega, \lambda)$ is a meromorphic family of operators $L^2 \rightarrow H^2$.

We now obtain a meromorphic decomposition for R_θ near zero using the framework of Grushin problems [137, Appendix C]. Let $i_1 : \mathbb{C} \rightarrow L^2(\mathbb{S}^2)$ be the operator of multiplication by the constant function 1 and $\pi_1 : H^2(\mathbb{S}^2) \rightarrow \mathbb{C}$ be the operator mapping every function to its integral over the standard measure on the round sphere. Consider the operator $A(\omega, \lambda) : H^2 \oplus \mathbb{C} \rightarrow L^2 \oplus \mathbb{C}$ given by

$$A(\omega, \lambda) = \begin{pmatrix} P_\theta(\omega) - \lambda & i_1 \\ \pi_1 & 0 \end{pmatrix}.$$

The kernel and cokernel of $P_\theta(0)$ are both one-dimensional and spanned by 1, since this is the Laplace–Beltrami operator for a certain Riemannian metric on the sphere. (Indeed, by ellipticity these spaces consist of smooth functions; by self-adjointness, the kernel and cokernel coincide; one can then apply Green’s formula [123, (2.4.8)] to an element of the kernel and itself.) Therefore [137, Theorem C.1], the operator $B(\omega, \lambda) = A(\omega, \lambda)^{-1}$ is well-defined at $(0, 0)$; then it is well-defined for (ω, λ) in an a -independent neighborhood of zero. We write

$$B(\omega, \lambda) = \begin{pmatrix} B_{11}(\omega, \lambda) & B_{12}(\omega, \lambda) \\ B_{21}(\omega, \lambda) & B_{22}(\omega, \lambda) \end{pmatrix}.$$

Now, by Schur’s complement formula we have near $(0, 0)$,

$$R_\theta(\omega, \lambda) = B_{11}(\omega, \lambda) - B_{12}(\omega, \lambda)B_{22}(\omega, \lambda)^{-1}B_{21}(\omega, \lambda).$$

However, $B_{22}(\omega, \lambda)$ is a holomorphic function of two variables, and we can find

$$B_{22}(\omega, \lambda) = \frac{\lambda}{4\pi} + O(|\omega|^2 + |\lambda|^2).$$

(The ω -derivative vanishes at zero since $\partial_\omega P_\omega(0)|_{\mathcal{D}'_0} = 0$. To compute the λ -derivative, we use that $B_{12}(0, 0) = i_1/4\pi$ and $B_{21}(0, 0) = \pi_1/4\pi$.) The decomposition (1.4.1) now follows by Weierstrass Preparation Theorem.

2. We have $P_\theta(\omega) = P_\theta(0) + P'_\theta(\omega)$, where

$$P'_\theta(\omega) = \frac{(1 + \alpha)^2 a\omega}{\Delta_\theta} (-2D_\varphi + a\omega \sin^2 \theta)$$

is a first order differential operator and

$$P_\theta(0) = \frac{1}{\sin \theta} D_\theta (\Delta_\theta \sin \theta D_\theta) + \frac{(1 + \alpha)^2}{\Delta_\theta \sin^2 \theta} D_\varphi^2 : H^2(\mathbb{S}^2) \rightarrow L^2(\mathbb{S}^2)$$

satisfies $P_\theta(0) \geq k^2$ on \mathcal{D}'_k ; therefore, if $u \in H^2(\mathbb{S}^2) \cap \mathcal{D}'_k$, then

$$\|u\|_{L^2} \leq \frac{\|(P_\theta(0) - \lambda)u\|_{L^2}}{d(\lambda, k^2 + \mathbb{R}^+)}.$$

Since

$$\|P'_\theta(\omega)\|_{L^2(\mathbb{S}^2) \cap \mathcal{D}'_k \rightarrow L^2(\mathbb{S}^2)} \leq 2(1 + \alpha)^2 |a\omega| (|a\omega| + |k|),$$

we get

$$\|u\|_{L^2} \leq \frac{\|(P_\theta(\omega) - \lambda)u\|_{L^2}}{d(\lambda, k^2 + \mathbb{R}^+) - C_1 |a\omega| (|a\omega| + |k|)}, \quad (1.4.5)$$

provided that the denominator is positive. Here C_1 is a global constant.

Now, if $|\lambda| \leq k^2/2$, then $d(\lambda, k^2 + \mathbb{R}^+) \geq k^2/2$ and

$$d(\lambda, k^2 + \mathbb{R}^+) - C_1 |a\omega| (|a\omega| + |k|) \geq \frac{k^2}{4} \text{ for } |k| \geq 8(1 + C_1) |a\omega|;$$

together with (1.4.5), this proves (1.4.2).

To prove (1.4.3), introduce

$$\text{Im } P_\theta(\omega) = \frac{1}{2} (P_\theta(\omega) - P_\theta(\omega)^*) = \frac{2(1 + \alpha)^2}{\Delta_\theta} a \text{Im } \omega (a \text{Re } \omega \sin^2 \theta - D_\varphi);$$

we have

$$\|\text{Im } P_\theta(\omega)\|_{L^2(\mathbb{S}^2) \cap \mathcal{D}'_k \rightarrow L^2(\mathbb{S}^2)} \leq 2(1 + \alpha)^2 |a \text{Im } \omega| (|a\omega| + |k|).$$

However, for $u \in H^2(\mathbb{S}^2) \cap \mathcal{D}'_k$,

$$\begin{aligned} \|(P_\theta(\omega) - \lambda)u\| \cdot \|u\| &\geq |\text{Im}((P_\theta(\omega) - \lambda)u, u)| \geq |\text{Im } \lambda| \cdot \|u\|^2 - |(\text{Im } P_\theta(\omega)u, u)| \\ &\geq (|\text{Im } \lambda| - 2(1 + \alpha)^2 |a| (|a\omega| + |k|) |\text{Im } \omega|) \|u\|^2 \end{aligned}$$

and we are done if $C_\theta \geq 4(1 + \alpha)^2$.

3. If $|\arg \lambda| \geq \psi$, then $d(\lambda, k^2 + \mathbb{R}^+) \geq (k^2 + |\lambda|)/C_2$; here C_2 is a constant depending on ψ . We have then

$$d(\lambda, k^2 + \mathbb{R}^+) - C_1 |a\omega| (|a\omega| + |k|) \geq \frac{1}{C_2} |\lambda| - C_3 |a\omega|^2$$

for some constant C_3 , and we are done by (1.4.5). \square

The analysis of the radial operator P_r is more complicated. In §§1.5–1.7, we prove

Proposition 1.4.2. *There exists a family of operators*

$$R_r(\omega, \lambda, k) : L^2_{\text{comp}}(r_-, r_+) \rightarrow H^2_{\text{loc}}(r_-, r_+), \quad (\omega, \lambda) \in \mathbb{C}^2,$$

with the following properties:

1. For each $k \in \mathbb{Z}$, $R_r(\omega, \lambda, k)$ is meromorphic with poles of finite rank in the sense of Definition 1.3.3, and $(P_r(\omega, k) + \lambda)R_r(\omega, \lambda, k)f = f$ for each $f \in L^2_{\text{comp}}(r_-, r_+)$. Also, for $k = 0$, R_r admits the following meromorphic decomposition near $\omega = \lambda = 0$:

$$R_r(\omega, \lambda, 0) = \frac{S_{r0}(\omega, \lambda)}{\lambda - \lambda_r(\omega)}, \quad (1.4.6)$$

where S_{r0} and λ_r are holomorphic in a -independent neighborhoods of zero and

$$\begin{aligned} S_{r0}(0, 0) &= \frac{1 \otimes 1}{r_+ - r_-}, \\ \lambda_r(\omega) &= \frac{i(1 + \alpha)(r_+^2 + r_-^2 + 2a^2)}{r_+ - r_-} \omega + O(|\omega|^2). \end{aligned}$$

2. Take $\delta_r > 0$. Then there exist $\psi > 0$ and C_r such that for

$$|\lambda| \geq C_r, \quad |\arg \lambda| \leq \psi, \quad |ak|^2 \leq |\lambda|/C_r, \quad |\omega|^2 \leq |\lambda|/C_r, \quad (1.4.7)$$

(ω, λ, k) is not a pole of R_r and we have

$$\|1_{K_r} R_r(\omega, \lambda, k) 1_{K_r}\|_{L^2 \rightarrow L^2} \leq \frac{C_r}{|\lambda|}. \quad (1.4.8)$$

Also, there exists $\delta_{r0} > 0$ such that, if $K_+ = [r_+ - \delta_{r0}, r_+]$ and $K_- = [r_-, r_- + \delta_{r0}]$, then for each N there exists a constant C_N such that under the conditions (1.4.7), we have

$$\|1_{K_{\pm}} |r - r_{\pm}|^{iA_{\pm}^{-1}(1+\alpha)((r_{\pm}^2 + a^2)\omega - ak)} R_r(\omega, \lambda, k) 1_{K_r}\|_{L^2 \rightarrow C^N(K_{\pm})} \leq \frac{C_N}{|\lambda|^N}. \quad (1.4.9)$$

3. There exists a constant C_{ω} such that $R_r(\omega, \lambda, k)$ does not have any poles for real λ and real ω with $|\omega| > C_{\omega}|ak|$.

4. Assume that R_r has a pole at (ω, λ, k) . Then there exists a nonzero solution $u \in C^{\infty}(r_-, r_+)$ to the equation $(P_r(\omega, k) + \lambda)u = 0$ such that the functions

$$|r - r_{\pm}|^{iA_{\pm}^{-1}(1+\alpha)((r_{\pm}^2 + a^2)\omega - ak)} u(r)$$

are real analytic at r_{\pm} , respectively.

5. Take $\delta_r > 0$. Then there exists $C_{1r} > 0$ such that for

$$\text{Im } \omega > 0, \quad |ak| \leq |\omega|/C_{1r}, \quad |\text{Im } \lambda| \leq |\omega| \cdot \text{Im } \omega / C_{1r}, \quad \text{Re } \lambda \geq -|\omega|^2 / C_{1r}, \quad (1.4.10)$$

(ω, λ, k) is not a pole of R_r and we have

$$\|1_{K_r} R_r(\omega, \lambda, k) 1_{K_r}\|_{L^2 \rightarrow L^2} \leq \frac{C_{1r}}{|\omega| \text{Im } \omega}. \quad (1.4.11)$$

Given these two propositions, we can now prove Theorems 1.1–1.4:

Proof of Theorem 1.1. Take $k \in \mathbb{Z}$ and an arbitrary $\delta_r > 0$; put $\mathcal{H}_1 = L^2(K_r)$, $\mathcal{H}_2 = L^2(\mathbb{S}^2) \cap \mathcal{D}'_k$, $R_1(\omega, \lambda) = R_r(\omega, \lambda, k)$, and $R_2(\omega, \lambda) = R_\theta(\omega, \lambda)|_{\mathcal{D}'_k}$; finally, let the angle ψ of admissible contours at infinity be chosen as in Proposition 1.4.2. We now apply Proposition 1.3.6. Condition (A) follows from the first parts of Propositions 1.4.1 and 1.4.2. Condition (B) follows from (1.4.4) and part 2 of Proposition 1.4.2. Finally, condition (C) holds because every $\omega \in \mathbb{R}$ with $|\omega| > C_\omega |ak|$, where C_ω is the constant from part 3 of Proposition 1.4.2, is regular. Indeed, $P_\theta(\omega)$ is self-adjoint and thus has only real eigenvalues. Now, by Proposition 1.3.6 we can use (1.3.1) to define $R_g(\omega, k)$ as a meromorphic family of operators on $L^2(X_K) \cap \mathcal{D}'_k$ with poles of finite rank. This can be done for any $\delta_r > 0$; therefore, $R_g(\omega, k)$ is defined as an operator $L^2_{\text{comp}}(X_0) \cap \mathcal{D}'_k \rightarrow L^2_{\text{loc}}(X_0) \cap \mathcal{D}'_k$.

Let us now prove that $P_g(\omega, k)R_g(\omega, k)f = f$ in the sense of distributions for each $f \in L^2_{\text{comp}}$. We will use the method of Proposition 1.3.1. Assume that ω is a regular point, so that $R_g(\omega, k)$ is well-defined. By analyticity, we can further assume that ω is real, so that $L^2(\mathbb{S}^2) \cap \mathcal{D}'_k$ has an orthonormal basis of eigenfunctions of $P_\theta(\omega)$. Then it suffices to prove that

$$I = (R_g(\omega, k)(f_r(r)f_\theta(\theta, \varphi)), P_g(\omega)(h_r(r)h_\theta(\theta, \varphi))) = (f_r, h_r) \cdot (f_\theta, h_\theta),$$

where $f_r, h_r \in C_0^\infty(r_-, r_+)$, $h_\theta \in C^\infty(\mathbb{S}^2) \cap \mathcal{D}'_k$, and $f_\theta \in \mathcal{D}'_k$ satisfies

$$P_\theta(\omega)f_\theta = \lambda_0 f_\theta, \quad \lambda_0 \in \mathbb{R}.$$

Take an admissible contour γ ; then

$$\begin{aligned} I &= \frac{1}{2\pi i} \int_\gamma (R_r(\omega, \lambda, k)f_r, P_r(\omega, k)h_r) \cdot (R_\theta(\omega, \lambda)f_\theta, h_\theta) \\ &\quad + (R_r(\omega, \lambda, k)f_r, h_r) \cdot (R_\theta(\omega, \lambda)f_\theta, P_\theta(\omega)h_\theta) d\lambda. \end{aligned}$$

However,

$$R_\theta(\omega, \lambda)f_\theta = \frac{f_\theta}{\lambda_0 - \lambda}.$$

It then follows from condition (B) that we can replace γ by a closed bounded contour γ' which contains λ_0 , but no poles of R_r . (To obtain γ' , we can cut off the infinite ends of γ sufficiently far and connect the resulting two endpoints by the arc $-\psi \leq \arg \lambda \leq \psi$; the integral over the arc can be made arbitrarily small.) Then

$$\begin{aligned} I &= \frac{1}{2\pi i} \int_{\gamma'} ((1 - \lambda R_r(\omega, \lambda, k))f_r, h_r) \cdot (R_\theta(\omega, \lambda)f_\theta, h_\theta) \\ &\quad + (R_r(\omega, \lambda, k)f_r, h_r) \cdot ((1 + \lambda R_\theta(\omega, \lambda))f_\theta, h_\theta) d\lambda \\ &= \frac{1}{2\pi i} \int_{\gamma'} (f_r, h_r) \cdot (R_\theta(\omega, \lambda)f_\theta, h_\theta) + (R_r(\omega, \lambda, k)f_r, h_r) \cdot (f_\theta, h_\theta) d\lambda \\ &= \frac{1}{2\pi i} \int_{\gamma'} \frac{(f_r, h_r)(f_\theta, h_\theta)}{\lambda_0 - \lambda} d\lambda = (f_r, h_r)(f_\theta, h_\theta), \end{aligned}$$

which finishes the proof.

Finally, the operator $P_g(\omega, k)$ is the restriction to \mathcal{D}'_k of the elliptic differential operator on X_0 obtained from $P_g(\omega)$ by replacing D_φ by k in the second term of (1.2.1). Therefore, by elliptic regularity (see for example [123, §7.4]) the operator $R_g(\omega, k)$ acts into H^2_{loc} . \square

Next, Theorem 1.2 follows from Theorem 1.1, the fact that the operator $P_g(\omega)$ is elliptic on X_K for small a (to get H^2 regularity instead of L^2), and the following estimate on $R_g(\omega, k)$ for large values of k :

Proposition 1.4.3. *Fix $\delta_r > 0$. Then there exists $a_0 > 0$ and a constant C_k such that for $|a| < a_0$ and $|k| \geq C_k(1 + |\omega|)$, ω is not a pole of $R_g(\cdot, k)$ and we have*

$$\|1_{X_K} R_g(\omega, k) 1_{X_K}\|_{L^2 \cap \mathcal{D}'_k \rightarrow L^2} \leq \frac{C_k}{|k|^2}. \quad (1.4.12)$$

Proof. Let ψ, C_r be the constants from part 2 of Proposition 1.4.2 and C_θ, C_ψ be the constants from Proposition 1.4.1. Put $\lambda_0 = k^2/3$; if C_k is large enough, then

$$|k| > 1 + C_\theta |a\omega|, \quad \lambda_0 > C_\psi |a\omega|^2 + C_r(1 + |\omega|^2).$$

Take the contour γ consisting of the rays $\{\arg \lambda = \pm\psi, |\lambda| \geq \lambda_0\}$ and the arc $\{|\lambda| = \lambda_0, |\arg \lambda| \leq \psi\}$. By (1.4.2) and (1.4.4), all poles of R_θ lie inside γ (namely, in the region $\{|\lambda| \geq \lambda_0, |\arg \lambda| \leq \psi\}$), and

$$\|R_\theta(\omega, \lambda)\|_{L^2(\mathbb{S}^2) \cap \mathcal{D}'_k \rightarrow L^2(\mathbb{S}^2)} \leq \frac{C}{|\lambda|} \quad (1.4.13)$$

for each λ on γ . Now, suppose that $|a| < a_0 = (3C_r)^{-1/2}$; then (1.4.7) is satisfied inside γ and (1.4.12) follows from (1.3.1), (1.4.8), and (1.4.13). \square

Proof of Theorem 1.3. 1. Fix $\delta_r > 0$ such that $\text{supp } f \subset X_K$. Take an admissible contour γ ; then by (1.3.1) and the fact that the considered functions are in \mathcal{D}'_k ,

$$v_\pm = \frac{1}{2\pi i} \int_\gamma (R_r^\pm(\omega, \lambda, k) \otimes R_\theta(\omega, \lambda)) f d\lambda, \quad (1.4.14)$$

where

$$R_r^\pm(\omega, \lambda, k) = |r - r_\pm|^{iA_\pm^{-1}(1+\alpha)((r_\pm^2 + a^2)\omega - ak)} R_r(\omega, \lambda, k).$$

By part 2 of Proposition 1.4.2, we may choose compact sets K_\pm containing r_\pm such that for each N , there exists a constant C_N (depending on ω, k , and γ) such that

$$\|1_{K_\pm} R_r^\pm(\omega, \lambda, k) 1_{K_r}\|_{L^2 \rightarrow C^N(K_\pm)} \leq \frac{C_N}{1 + |\lambda|}, \quad \lambda \in \gamma.$$

(The estimate is true over a compact portion of γ since the image of R_r^\pm consists of functions smooth at $r = r_\pm$, by the construction in §1.5.) Now, by (1.4.4) we get for some constant C'_N ,

$$\|R_r^\pm(\omega, \lambda, k) \otimes R_\theta(\omega, \lambda) f\|_{C^N(K_\pm; L^2(\mathbb{S}^2))} \leq \frac{C'_N \|f\|_{L^2}}{1 + |\lambda|^2};$$

by (1.4.14), $v_\pm \in C^\infty(K_\pm; L^2(\mathbb{S}^2))$.

Now, since $(P_r + P_\theta)u = f$ and (assuming that $K_\pm \cap K_r = \emptyset$) $f|_{K_\pm \times \mathbb{S}^2} = 0$, we have $(P_r^\pm(\omega, k) + P_\theta(\omega))v_\pm = 0$ on $K_\pm \times \mathbb{S}^2$, where

$$P_r^\pm(\omega, k) = |r - r_\pm|^{iA_\pm^{-1}(1+\alpha)((r_\pm^2+a^2)\omega - ak)} P_r(\omega, k) |r - r_\pm|^{-iA_\pm^{-1}(1+\alpha)((r_\pm^2+a^2)\omega - ak)}$$

has smooth coefficients on K_\pm (see 1.5). Then for each N ,

$$P_\theta^N v_\pm = (-P_r^\pm)^N v_\pm \in C^\infty(K_\pm; L^2(\mathbb{S}^2));$$

since P_θ is elliptic, we get $v_\pm \in C^\infty(K_\pm; H^{2N}(\mathbb{S}^2))$. Therefore, $v_\pm \in C^\infty(K_\pm \times \mathbb{S}^2)$.

2. Let ω be a pole of $R_g(\omega, k)$. Then ω is not a regular point; therefore, there exists $\lambda \in \mathbb{C}$ such that (ω, λ) is a pole of both R_r and R_θ . This gives us functions $u_r(r)$ and $u_\theta(\theta, \varphi) \in \mathcal{D}'_k$ such that $(P_r(\omega, k) + \lambda)u_r = 0$ and $(P_\theta(\omega) - \lambda)u_\theta = 0$. It remains to take $u = u_r \otimes u_\theta$ and use part 4 of Proposition 1.4.2. \square

The following fact will be used in the proof of Theorem 1.4, as well as in §1.8:

Proposition 1.4.4. *Fix $\delta_r > 0$. Let ψ, C_r be the constants from part 2 of Proposition 1.4.2, C_θ, C_ψ be the constants from Proposition 1.4.1, and C_k be the constant from Proposition 1.4.3. Take $\omega \in \mathbb{C}$ and put*

$$L = (C_r(1 + C_k)^2 + C_\psi)(1 + |\omega|)^2.$$

Assume that a is small enough so that Proposition 1.4.3 applies and suppose that ω and $l_1, l_2 > 0$ are chosen so that

$$l_1 \geq C_\psi |a\omega|^2, \quad l_2 \geq C_\theta |a| (|a\omega| + C_k(1 + |\omega|)) |\operatorname{Im} \omega|, \quad l_2 \leq L \sin \psi. \quad (1.4.15)$$

Also, assume that for all λ and k satisfying

$$|k| \leq C_k(1 + |\omega|), \quad -l_1 \leq \operatorname{Re} \lambda \leq L, \quad |\operatorname{Im} \lambda| \leq l_2, \quad (1.4.16)$$

we have the estimate

$$\|1_{K_r} R_r(\omega, \lambda, k) 1_{K_r}\|_{L^2 \rightarrow L^2} \leq C_1 \quad (1.4.17)$$

for some constant C_1 independent of λ and k . Then ω is not a resonance and

$$\|R_g(\omega)\|_{L^2(X_K) \rightarrow L^2(X_K)} \leq C_2 \left(\frac{1}{1 + |\omega|^2} + \frac{1 + C_1(l_1 + 1 + |\omega|^2)}{l_2} + \frac{C_1 l_2}{l_1} \right) \quad (1.4.18)$$

for a certain global constant C_2 .

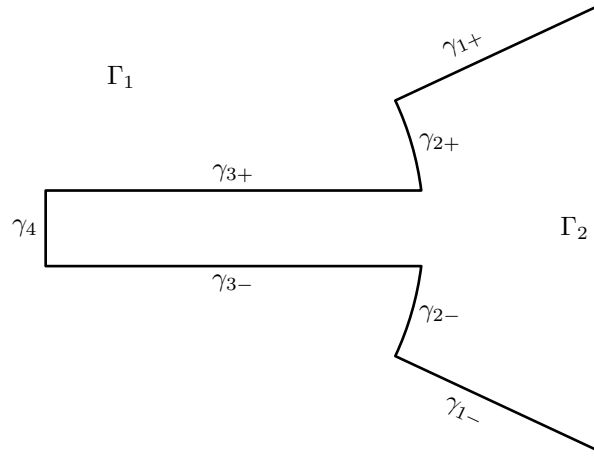

Figure 1.2: The admissible contour γ used in Proposition 1.4.4.

Proof. First of all, by Proposition 1.4.3, it suffices to establish the estimate (1.4.18) for the operator $R_g(\omega, k)$, where $|k| \leq C_k(1 + |\omega|)$. Now, by (1.3.1), it suffices to construct an admissible contour in the sense of Definition 1.3.5 and estimate the norms of R_r and R_θ on this contour. We take the contour γ composed of:

- the rays $\gamma_{1\pm} = \{\arg \lambda = \pm\psi, |\lambda| \geq L\}$;
- the arcs $\gamma_{2\pm} = \{|\arg \lambda| \leq \psi, |\lambda| = L, \pm \operatorname{Im} \lambda \geq l_2\}$;
- the segments $\gamma_{3\pm}$ of the lines $\{\operatorname{Im} \lambda = \pm l_2\}$ connecting $\gamma_{2\pm}$ with γ_4 ;
- the segment $\gamma_4 = \{\operatorname{Re} \lambda = -l_1, |\operatorname{Im} \lambda| \leq l_2\}$.

Then γ divides the complex plane into two domains; we refer to the domain containing positive real numbers as Γ_2 and to the other domain as Γ_1 . We claim that $R_\theta(\omega, \cdot)|_{\mathcal{D}'_k}$ has no poles in Γ_1 , $R_r(\omega, \cdot, k)$ has no poles in Γ_2 , and the $L^2 \rightarrow L^2$ operator norm estimates

$$\|R_\theta(\omega, \lambda)\| \leq C/|\lambda|, \quad \|1_{K_r} R_r(\omega, \lambda, k) 1_{K_r}\| \leq C/|\lambda|, \quad \lambda \in \gamma_{1\pm}; \quad (1.4.19)$$

$$\|R_\theta(\omega, \lambda)|_{\mathcal{D}'_k}\| \leq C/l_2, \quad \|1_{K_r} R_r(\omega, \lambda, k) 1_{K_r}\| \leq C/(1 + |\omega|^2), \quad \lambda \in \gamma_{2\pm}; \quad (1.4.20)$$

$$\|R_\theta(\omega, \lambda)|_{\mathcal{D}'_k}\| \leq C/l_2, \quad \|1_{K_r} R_r(\omega, \lambda, k) 1_{K_r}\| \leq C_1, \quad \lambda \in \gamma_{3\pm}; \quad (1.4.21)$$

$$\|R_\theta(\omega, \lambda)\| \leq C/l_1, \quad \|1_{K_r} R_r(\omega, \lambda, k) 1_{K_r}\| \leq C_1, \quad \lambda \in \gamma_4 \quad (1.4.22)$$

hold for some global constant C ; then (1.4.18) follows from these estimates and (1.3.1).

First, we prove that $R_\theta(\omega, \cdot)|_{\mathcal{D}'_k}$ has no poles $\lambda \in \Gamma_1$. First of all, assume that $|\lambda| \geq L$. Then $|\arg \lambda| \geq \psi$ and we can apply part 3 of Proposition 1.4.1; we also get the first half of (1.4.19). Same argument works for $\operatorname{Re} \lambda \leq -l_1$, and we get the first half of (1.4.22). We may now assume that $|\lambda| \leq L$ and $\operatorname{Re} \lambda \geq -l_1$; it follows that $|\operatorname{Im} \lambda| \geq l_2$. But in that case, we can apply (1.4.3), and we get the first halves of (1.4.20) and (1.4.21).

Next, we prove that $R_r(\omega, \cdot, k)$ has no poles $\lambda \in \Gamma_2$. First of all, assume that $|\lambda| \geq L$ and $\operatorname{Re} \lambda \geq 0$. Then $|\arg \lambda| \leq \psi$ and we can apply part 2 of Proposition 1.4.2; we also get the second halves of (1.4.19) and (1.4.20). Now, in the opposite case, (1.4.16) is satisfied and we can use (1.4.17) to get the second halves of (1.4.21) and (1.4.22). \square

Proof of Theorem 1.4. First, we take care of the resonances near zero. By Proposition 1.4.3, we can assume that k is bounded by some constant. Next, if $\omega = 0$ and $a = 0$, then $R_g(\omega, k)$ only has a pole for $k = 0$, and in the latter case, $\lambda = 0$ is the only common pole of $R_\theta(0, \cdot)$ and $R_r(0, \cdot, 0)$. (In fact, the poles of $R_\theta(0, \cdot)|_{\mathcal{D}'_k}$ are given by $\lambda = l(l+1)$ for $l \geq |k|$; an integration by parts argument shows that $R_r(0, \cdot, k)$ cannot have poles with $\operatorname{Re} \lambda > 0$.) The sets of poles of the resolvents $R_\theta(\omega, \lambda)|_{\mathcal{D}'_k}$ and $R_r(\omega, \lambda, k)$ depend continuously on a in the sense that, if there are no poles of one of these resolvents for (ω, λ) in a fixed compact set for $a = 0$, then this is still true for a small enough. It follows from here and the first parts of Propositions 1.4.1 and 1.4.2 that there exists $\varepsilon_\omega, \varepsilon_\lambda > 0$ such that for a small enough,

- $R_g(\omega, k)$ does not have poles in $\{|\omega| \leq \varepsilon_\omega\}$ unless $k = 0$;
- if $|\omega| \leq \varepsilon_\omega$, then all common poles of $R_\theta(\omega, \cdot)|_{\mathcal{D}'_0}$ and $R_r(\omega, \cdot, 0)$ lie in $\{|\lambda| \leq \varepsilon_\lambda\}$;
- the decompositions (1.4.1) and (1.4.6) hold for $|\omega| \leq \varepsilon_\omega, |\lambda| \leq \varepsilon_\lambda$;
- we have $\lambda_r(\omega) \neq \lambda_\theta(\omega)$ for $0 < |\omega| \leq \varepsilon_\omega$.

It follows immediately that $\omega = 0$ is the only pole of R_g in $\{|\omega| \leq \varepsilon_\omega\}$. To get the meromorphic decomposition, we repeat the argument at the end of §1.3 in our particular case. Note that for small $\omega \neq 0$,

$$R_g(\omega, 0) = \frac{1}{2\pi i} \int_\gamma R_r(\omega, \lambda, 0) \otimes R_\theta(\omega, \lambda)|_{\mathcal{D}'_0} d\lambda + \operatorname{Hol}(\omega)$$

Here γ is a small contour surrounding $\lambda_\theta(\omega)$, but not $\lambda_r(\omega)$; the integration is done in the clockwise direction; Hol denotes a family of operators holomorphic near zero. By (1.4.1) and (1.4.6), we have

$$\begin{aligned} R_g(\omega, 0) &= \operatorname{Hol}(\omega) + \frac{1}{2\pi i} \int_\gamma \frac{S_{r0}(\omega, \lambda) \otimes S_{\theta0}(\omega, \lambda)}{(\lambda - \lambda_r(\omega))(\lambda - \lambda_\theta(\omega))} d\lambda \\ &= \operatorname{Hol}(\omega) + \frac{1}{\lambda_r(\omega) - \lambda_\theta(\omega)} \frac{1}{2\pi i} \int_\gamma (S_{r0}(\omega, \lambda) \otimes S_{\theta0}(\omega, \lambda)) \left(\frac{1}{\lambda - \lambda_r(\omega)} - \frac{1}{\lambda - \lambda_\theta(\omega)} \right) d\lambda \\ &= \operatorname{Hol}(\omega) + \frac{1}{\lambda_r(\omega) - \lambda_\theta(\omega)} S_{r0}(\omega, \lambda_\theta(\omega)) \otimes S_{\theta0}(\omega, \lambda_\theta(\omega)) \\ &= \operatorname{Hol}(\omega) + \frac{i(1 \otimes 1)}{4\pi(1 + \alpha)(r_+^2 + r_-^2 + 2a^2)\omega}. \end{aligned}$$

Now, let us consider the case $|\omega| > \varepsilon_\omega, \operatorname{Im} \omega > 0$. We will apply Proposition 1.4.4 with $l_1 = |\omega|^2/C_{1r}, l_2 = |\omega| \operatorname{Im} \omega/C_{1r}$. Here C_{1r} is the constant in Proposition 1.4.2. Then (1.4.15)

is true for small a and (1.4.17) follows from (1.4.16) for small a by part 5 of Proposition 1.4.2, with $C_1 = C_{1r}/(|\omega| \operatorname{Im} \omega)$. It remains to use (1.4.18).

Finally, assume that ω is a real k -resonance and $|\omega| > \varepsilon_\omega$. Then by Proposition 1.4.3, and part 3 of Proposition 1.4.2, if a is small enough, then the operator $R_r(\omega, \cdot, k)$ cannot have a pole for $\lambda \in \mathbb{R}$. However, the operator $P_\theta(\omega)$ is self-adjoint and thus only has real eigenvalues, a contradiction. \square

1.5 Construction of the radial resolvent

In this section, we prove Proposition 1.4.2, except for part 2, which is proved in §1.7. We start with a change of variables that maps (r_-, r_+) to $(-\infty, \infty)$:

Proposition 1.5.1. *Define $x = x(r)$ by*

$$x = \int_{r_0}^r \frac{ds}{\Delta_r(s)}. \quad (1.5.1)$$

(Here $r_0 \in (r_-, r_+)$ is a fixed number.) Then there exists a constant R_0 such that for $\pm x > R_0$, we have $r = r_\pm \mp F_\pm(e^{\mp A \pm x})$, where $F_\pm(w)$ are real analytic on $[0, e^{-A \pm R_0})$ and holomorphic in the discs $\{|w| < e^{-A \pm R_0}\} \subset \mathbb{C}$.

Proof. We concentrate on the behavior of x near r_+ . It is easy to see that $-A_+x(r) = \ln(r_+ - r) + G(r)$, where G is holomorphic near $r = r_+$. Exponentiating, we get

$$w = e^{-A_+x} = (r_+ - r)e^{G(r)}.$$

It remains to apply the inverse function theorem to solve for r as a function of w near zero. \square

After the change of variables $r \rightarrow x$, we get $P_r(\omega, k) + \lambda = \Delta_r^{-1}P_x(\omega, \lambda, k)$, where

$$\begin{aligned} P_x(\omega, \lambda, k) &= D_x^2 + V_x(x; \omega, \lambda, k), \\ V_x &= \lambda \Delta_r - (1 + \alpha)^2((r^2 + a^2)\omega - ak)^2. \end{aligned} \quad (1.5.2)$$

(We treat r and Δ_r as functions of x now.) We put

$$\omega_\pm = (1 + \alpha)((r_\pm^2 + a^2)\omega - ak), \quad (1.5.3)$$

so that $V_x(\pm\infty) = -\omega_\pm^2$. Also, by Proposition 4.1, we get

$$V_x(x) = V_\pm(e^{\mp A \pm x}), \quad \pm x > R_0, \quad (1.5.4)$$

where $V_\pm(w)$ are functions holomorphic in the discs $\{|w| < e^{-A \pm R_0}\}$.

We now define outgoing functions:

Definition 1.5.2. Fix ω, k, λ . A function $u(x)$ (and the corresponding function of r) is called *outgoing at $\pm\infty$* iff

$$u(x) = e^{\pm i\omega_{\pm}x} v_{\pm}(e^{\mp A_{\pm}x}), \quad (1.5.5)$$

where $v_{\pm}(w)$ are holomorphic in a neighborhood of zero. We call $u(x)$ *outgoing* if it is outgoing at both infinities.

Let us construct certain solutions outgoing at one of the infinities:

Proposition 1.5.3. There exist solutions $u_{\pm}(x; \omega, \lambda, k)$ to the equation $P_x u_{\pm} = 0$ of the form

$$u_{\pm}(x; \omega, \lambda, k) = e^{\pm i\omega_{\pm}x} v_{\pm}(e^{\mp A_{\pm}x}; \omega, \lambda, k),$$

where $v_{\pm}(w; \omega, \lambda, k)$ is holomorphic in $\{|w| < W_{\pm}\}$ and

$$v_{\pm}(0; \omega, \lambda, k) = \frac{1}{\Gamma(1 - 2i\omega_{\pm}A_{\pm}^{-1})}. \quad (1.5.6)$$

These solutions are holomorphic in (ω, λ) and are unique unless $\nu = 2i\omega_{\pm}A_{\pm}^{-1}$ is a positive integer.

Proof. We only construct the function u_+ . Let us write the Taylor series for v_+ at zero:

$$v_+(w) = \sum_{j \geq 0} v_j w^j.$$

Put $w = e^{-A_+x}$; then the equation $P_x u_+ = 0$ is equivalent to

$$((A_+ w D_w - \omega_+)^2 + V_x) v_{\pm} = 0.$$

By (1.5.2) and Proposition 1.5.1, V_x is a holomorphic function of w for $|w| < W_+$. If $V_x = \sum_{j \geq 0} V_j w^j$ is the corresponding Taylor series, then we get the following system of linear equations on the coefficients v_j :

$$jA_+(2i\omega_+ - jA_+)v_j + \sum_{0 < l \leq j} V_l v_{j-l} = 0, \quad j > 0. \quad (1.5.7)$$

If ν is not a positive integer, then this system has a unique solution under the condition $v_0 = \Gamma(1 - \nu)^{-1}$. This solution can be uniquely holomorphically continued to include the cases when ν is a positive integer. Indeed, one defines the coefficients v_0, \dots, v_{ν} by Cramer's Rule using the first ν equations in (1.5.7) (this can be done since the zeroes of the determinant of the corresponding matrix match the poles of the gamma function), and the rest are uniquely determined by the remaining equations in the system (1.5.7).

We now prove that the series above converges in the disc $\{|w| < W_+\}$. We take $\varepsilon > 0$; then $|V_j| \leq M(W_+ - \varepsilon)^{-j}$ for some constant M . Then one can use induction and (1.5.7) to see that $|v_j| \leq C(W_+ - \varepsilon)^{-j}$ for some constant C . Therefore, the Taylor series for v converges in the disc $\{|w| < W_+ - \varepsilon\}$; since ε was arbitrary, we are done. \square

The condition (1.5.6) makes it possible for u_{\pm} to be zero for certain values of ω_{\pm} . However, we have the following

Proposition 1.5.4. *Assume that one of the solutions u_{\pm} is identically zero. Then every solution u to the equation $P_x u = 0$ is outgoing at the corresponding infinity.*

Proof. Assume that $u_+(x; \omega_0, \lambda_0, k_0) \equiv 0$. (The argument for u_- is similar.) Put $\nu = 2i\omega_0 A_+^{-1}$; by (1.5.6), it has to be a positive integer. Similarly to Proposition 1.5.3, we can construct a nonzero solution u_1 to the equation $P_x u_1 = 0$ with

$$u_1(x) = e^{-i\omega_0 x} \tilde{v}_1(e^{-A_+ x})$$

and \tilde{v}_1 holomorphic at zero. We can see that $u_1(x) = e^{i\omega_0 x} v_1(e^{-A_+ x})$, where $v_1(w) = w^{\nu} \tilde{v}_1(w)$ is holomorphic; therefore, u_1 is outgoing. Note that $u_1(x) = o(e^{i\omega_0 x})$ as $x \rightarrow +\infty$.

Now, since $u_+(x; \omega_0, \lambda_0, k_0) \equiv 0$, we can define

$$u_2(x) = \lim_{\omega \rightarrow \omega_0} \Gamma(1 - 2i\omega_+ A_+^{-1}) u_+(x; \omega, \lambda_0, k_0);$$

it will be an outgoing solution to the equation $P_x u_2 = 0$ and have $u_2(x) = e^{i\omega_0 x} (1 + o(1))$ as $x \rightarrow +\infty$. We have constructed two linearly independent outgoing solutions to the equation $P_x u = 0$; since this equation only has a two-dimensional space of solutions, every its solution must be outgoing. \square

The next statement follows directly from the definition of an outgoing solution and will be used in later sections:

Proposition 1.5.5. *Fix $\delta_r > 0$ and let K_x be the image of the set $K_r = (r_- + \delta_r, r_+ - \delta_r)$ under the change of variables $r \rightarrow x$. Assume that R_0 is chosen large enough so that Proposition 1.5.1 holds and $K_x \subset (-R_0, R_0)$. Let $u(x) \in H_{\text{loc}}^2(\mathbb{R})$ be any outgoing function in the sense of Definition 1.5.2 and assume that $f = P_x u$ is supported in K_x . Then:*

1. *u can be extended holomorphically to the two half-planes $\{\pm \text{Re } z > R_0\}$ and satisfies the equation $P_z u = 0$ in these half-planes, where $P_z = D_z^2 + V_x(z)$ and $V_x(z)$ is well-defined by (1.5.4).*

2. *If γ is a contour in the complex plane given by $\text{Im } z = F(\text{Re } z)$, $x_- \leq \text{Re } z \leq x_+$, and $F(x) = 0$ for $|x| \leq R_0$, then we can define the restriction to γ of the holomorphic extension of u by*

$$u_{\gamma}(x) = u(x + iF(x))$$

and u_{γ} satisfies the equation $P_{\gamma} u_{\gamma} = f$, where

$$P_{\gamma} = \left(\frac{1}{1 + iF'(x)} D_x \right)^2 + V_x(x + iF(x)).$$

3. *Assume that γ is as above, with $x_{\pm} = \pm\infty$, and $F'(x) = c = \text{const}$ for large $|x|$. Then $u_{\gamma}(x) = O(e^{\mp \text{Im}((1+ic)\omega_{\pm})x})$ as $x \rightarrow \pm\infty$. As a consequence, if $\text{Im}((1+ic)\omega_{\pm}) > 0$, then $u_{\gamma}(x) \in H^2(\mathbb{R})$.*

We are now ready to prove Proposition 1.4.2.

Proof of part 1. Given the functions u_{\pm} , define the operator $S_x(\omega, \lambda, k)$ on \mathbb{R} by its Schwartz kernel

$$S_x(x, x'; \omega, \lambda, k) = u_+(x)u_-(x')[x > x'] + u_-(x)u_+(x')[x < x'].$$

The operator $S_x(\omega, \lambda)$ acts $L^2_{\text{comp}}(\mathbb{R}) \rightarrow H^2_{\text{loc}}(\mathbb{R})$ and $P_x S_x = W(\omega, \lambda, k)$, where the Wronskian

$$W(\omega, \lambda, k) = u_+(x; \omega, \lambda, k) \cdot \partial_x u_-(x; \omega, \lambda, k) - u_-(x; \omega, \lambda, k) \cdot \partial_x u_+(x; \omega, \lambda, k)$$

is constant in x . Moreover, $W(\omega, \lambda, k) = 0$ if and only if $u_+(x; \omega, \lambda, k)$ and $u_-(x; \omega, \lambda, k)$ are linearly dependent as functions of x . Also, the image of S_x consists of outgoing functions.

Now, we define the radial resolvent $R_r(\omega, \lambda, k) = R_x(\omega, \lambda, k)\Delta_r$, where

$$R_x(\omega, \lambda, k) = \frac{S_x(\omega, \lambda, k)}{W(\omega, \lambda, k)}. \quad (1.5.8)$$

It is clear that R_r is a meromorphic family of operators $L^2_{\text{comp}} \rightarrow H^2_{\text{loc}}$ and $(P_r + \lambda)R_r$ is the identity operator. We now prove that R_x , and thus R_r , has poles of finite rank. Fix k and take $(\omega_0, \lambda_0) \in \{W = 0\}$; we need to prove that for every l , the principal part of the Laurent decomposition of $\partial_{\omega}^l R_x(\omega_0, \lambda, k)$ at $\lambda = \lambda_0$ consists of finite-dimensional operators. We use induction on l . One has $P_x(\omega, \lambda, k)R_x(\omega, \lambda, k) = 1$; differentiating this identity l times in ω , we get

$$P_x(\omega_0, \lambda, k)\partial_{\omega}^l R_x(\omega_0, \lambda, k) = \delta_{l0}1 + \sum_{m=1}^l c_{ml}\partial_{\omega}^m P_x(\omega_0, \lambda, k)\partial_{\omega}^{l-m} R_x(\omega_0, \lambda, k).$$

(Here c_{ml} are some constants.) The right-hand side has poles of finite rank by the induction hypothesis. Now, consider the Laurent decomposition

$$\partial_{\omega}^l R_x(\omega_0, \lambda, k) = Q(\lambda) + \sum_{j=1}^N \frac{R_j}{(\lambda - \lambda_0)^j}.$$

Here Q is holomorphic at λ_0 . Multiplying by P_x , we get

$$\sum_{j=1}^N \frac{P_x(\omega_0, \lambda, k)R_j}{(\lambda - \lambda_0)^j} \sim \sum_{j=1}^N \frac{L_j}{(\lambda - \lambda_0)^j}$$

up to operators holomorphic at λ_0 . Here L_j are some finite-dimensional operators. We then have

$$\begin{aligned} P_x(\omega_0, \lambda_0, k)R_N &= L_N, \\ P_x(\omega_0, \lambda_0, k)R_{N-1} &= L_{N-1} - (\partial_{\lambda} P_x(\omega_0, \lambda_0, k))R_N, \dots \end{aligned}$$

Each of the right-hand sides has finite rank and the kernel of $P_x(\omega_0, \lambda_0, k)$ is two-dimensional; therefore, each R_j is finite-dimensional as required. (We also see immediately that the image of each R_j consists of smooth functions.)

Finally, we establish the decomposition at zero. As in part 1 of Proposition 1.4.1, it suffices to compute $S_x(0, 0, 0)$ and the first order terms in the Taylor expansion of W at $(0, 0, 0)$. We have $u_{\pm}(x; 0, 0, 0) = 1$ for all x ; therefore, $S_x(x, x'; 0, 0, 0) = 1$. Next, put $u_{\omega\pm}(x) = \partial_{\omega}u_{\pm}(x; 0, 0, 0)$ and $u_{\lambda\pm}(x) = \partial_{\lambda}u_{\pm}(x; 0, 0, 0)$. By differentiating the equation $P_x u_{\pm} = 0$ in ω and λ and recalling the boundary conditions at $\pm\infty$, we get

$$\begin{aligned} \partial_x^2 u_{\lambda\pm}(x) &= \Delta_r, \\ u_{\lambda\pm}(x) &= v_{\lambda\pm}(e^{\mp A\pm x}), \quad \pm x \gg 0; \\ \partial_x^2 u_{\omega\pm}(x) &= 0, \\ u_{\omega\pm}(x) &= \pm i(1 + \alpha)(r_{\pm}^2 + a^2)x + v_{\omega\pm}(e^{\mp A\pm x}), \quad \pm x \gg 0, \end{aligned}$$

for some functions $v_{\lambda\pm}, v_{\omega\pm}$ real analytic at zero. We then find

$$\begin{aligned} \partial_{\lambda}W(0, 0, 0) &= \partial_x(u_{-\lambda} - u_{+\lambda}) = \int_{-\infty}^{\infty} \Delta_r dx = r_+ - r_-, \\ \partial_{\omega}W(0, 0, 0) &= \partial_x(u_{-\omega} - u_{+\omega}) = -i(1 + \alpha)(r_+^2 + r_-^2 + 2a^2). \quad \square \end{aligned}$$

Proof of part 3. Assume that ω and λ are both real and R_r has a pole at (ω, λ, k) . Let $u(x)$ be the corresponding resonant state; we know that it has the asymptotics

$$\begin{aligned} u_{\pm}(x) &= e^{\pm i\omega_{\pm}x} U_{\pm}(1 + O(e^{\mp A\pm x})), \quad x \rightarrow \pm\infty; \\ \partial_x u_{\pm}(x) &= e^{\pm i\omega_{\pm}x} U_{\pm}(\pm i\omega_{\pm} + O(e^{\mp A\pm x})), \quad x \rightarrow \pm\infty \end{aligned}$$

for some nonzero constants U_{\pm} . Since $V_x(x; \omega, \lambda, k)$ is real-valued, both u and \bar{u} solve the equation $(D_x^2 + V_x(x))u = 0$. Then the Wronskian $W_u(x) = u \cdot \partial_x \bar{u} - \bar{u} \cdot \partial_x u$ must be constant; however,

$$W_u(x) \rightarrow \mp 2i\omega_{\pm}|U_{\pm}|^2 \text{ as } x \rightarrow \pm\infty.$$

Then we must have $\omega_+ \omega_- \leq 0$; it follows immediately that $|\omega| = O(|ak|)$. \square

Proof of part 4. First, assume that neither of u_{\pm} is identically zero. Then the resolvent R_x , and thus R_r , has a pole iff the functions u_{\pm} are linearly dependent, or, in other words, if there exists a nonzero outgoing solution $u(x)$ to the equation $P_x u = 0$. Now, if one of u_{\pm} , say, u_+ , is identically zero, then by Proposition 1.5.4, u_- will be an outgoing solution at both infinities. \square

Proof of part 5. Assume that $u(x)$ is outgoing and $P_x(\omega, \lambda, k)u = f \in L^2(K_x)$. Since $\text{Im } \omega > 0$, we have $\text{Im } \omega_{\pm} > 0$ and thus $u \in H^2(\mathbb{R})$.

First, assume that $|\arg \omega - \pi/2| < \varepsilon$, where $\varepsilon > 0$ is a constant to be chosen later. Then

$$\text{Re } V_x(x) = (1 + \alpha)^2(r^2 + a^2)^2(\text{Im } \omega)^2 + \text{Re } \lambda \cdot \Delta_r - (1 + \alpha)^2((r^2 + a^2) \text{Re } \omega - ak)^2;$$

using (1.4.10), we can choose ε and C_{1r} so that $\operatorname{Re} V_x(x) \geq |\omega|^2/C > 0$ for all $x \in \mathbb{R}$. Then

$$\begin{aligned} \|u\|_{L^2(\mathbb{R})} \cdot \|f\|_{L^2(\mathbb{R})} &\geq \operatorname{Re} \int \bar{u}(x)(D_x^2 + V_x(x))u(x) dx \\ &\geq \int \operatorname{Re} V_x(x)|u|^2 dx \geq C^{-1}|\omega|^2\|u\|_{L^2(\mathbb{R})}^2 \end{aligned}$$

and (1.4.11) follows.

Now, assume that $|\arg \omega - \pi/2| \geq \varepsilon$. Then

$$\operatorname{Im} V_x(x) = -2(1 + \alpha)^2((r^2 + a^2) \operatorname{Re} \omega - ak)(r^2 + a^2) \operatorname{Im} \omega + \operatorname{Im} \lambda \cdot \Delta_r;$$

it follows from (1.4.10) that we can choose C_{1r} so that the sign of $\operatorname{Im} V_x(x)$ is constant in x (positive if $\arg \omega > \pi/2$ and negative otherwise) and, in fact, $|\operatorname{Im} V_x(x)| \geq |\omega| \operatorname{Im} \omega/C > 0$ for all x . Then (assuming that $\operatorname{Im} V_x(x) > 0$)

$$\begin{aligned} \|u\|_{L^2(\mathbb{R})} \cdot \|f\|_{L^2(\mathbb{R})} &\geq \operatorname{Im} \int \bar{u}(x)(D_x^2 + V_x(x))u(x) dx \\ &= \int \operatorname{Im} V_x(x)|u|^2 dx \geq C^{-1}|\omega| \operatorname{Im} \omega \|u\|_{L^2(\mathbb{R})}^2 \end{aligned}$$

and (1.4.11) follows. □

1.6 Semiclassical preliminaries for radial analysis

In this section, we list certain facts from semiclassical analysis needed in the further analysis of our radial operator. For a general introduction to semiclassical analysis, the reader is referred to [137].

Let $a(x, \xi)$ belong to the symbol class

$$S^m = \{a(x, \xi) \in C^\infty(\mathbb{R}^2) \mid \sup_{x, \xi} \langle \xi \rangle^{|\beta|-m} |\partial_x^\alpha \partial_\xi^\beta a(x, \xi)| \leq C_{\alpha\beta} \text{ for all } \alpha, \beta\}.$$

Here $m \in \mathbb{R}$ and $\langle \xi \rangle = \sqrt{1 + |\xi|^2}$. Following [137, §8.6], we define the corresponding semiclassical pseudodifferential operator $a^w(x, hD_x)$ by the formula

$$a^w(x, hD_x)u(x) = \frac{1}{2\pi h} \int e^{\frac{i}{h}(x-y)\eta} a\left(\frac{x+y}{2}, \eta\right) u(y) dy d\eta.$$

Here $h > 0$ is the semiclassical parameter. We denote by Ψ^m the class of all semiclassical pseudodifferential operators with symbols in S^m . Introduce the semiclassical Sobolev spaces $H_h^l \subset \mathcal{D}'(\mathbb{R})$ with the norm $\|u\|_{H_h^l} = \|\langle hD_x \rangle^l u\|_{L^2}$; then for $a \in S^m$, we have

$$\|a^w(x, hD_x)\|_{H_h^l \rightarrow H_h^{l-m}} \leq C,$$

where C is a constant depending on a , but not on h . Also, if $a(x, \xi) \in C_0^\infty(\mathbb{R}^2)$, then

$$\|a^w(x, hD_x)\|_{L^2(\mathbb{R}) \rightarrow L^\infty(\mathbb{R})} \leq Ch^{-1/2}, \quad (1.6.1)$$

where C is a constant depending on a , but not on h . (See [137, Theorem 7.10] for the proof.)

General facts on multiplication of pseudodifferential operators can be found in [137, §8.6]. We will need the following: for $a \in S^m$ and $b \in S^n$,⁴

$$\text{if } \text{supp } a \cap \text{supp } b = \emptyset, \text{ then } a^w(x, hD_x)b^w(x, hD_x) = O_{L^2 \rightarrow H_h^N}(h^\infty) \text{ for all } N; \quad (1.6.2)$$

$$a^w(x, hD_x)b^w(x, hD_x) = (ab)^w(x, hD_x) + O_{\Psi^{m+n-1}}(h), \quad (1.6.3)$$

$$[a^w(x, hD_x), b^w(x, hD_x)] = -ih\{a, b\}^w(x, hD_x) + O_{\Psi^{m+n-2}}(h^2). \quad (1.6.4)$$

Here $\{\cdot, \cdot\}$ is the Poisson bracket, defined by $\{a, b\} = \partial_\xi a \cdot \partial_x b - \partial_\xi b \cdot \partial_x a$. Also, if $A \in \Psi^m$, then the adjoint operator A^* also lies in Ψ^m and its symbol is the complex conjugate of the symbol of A .

One can study pseudodifferential operators on manifolds [137, Appendix E], and on particular on the circle $\mathbb{S}^1 = \mathbb{R}/2\pi\mathbb{Z}$. If $a(x, \xi) = a(\xi)$ is a symbol on $T^*\mathbb{S}^1$ that is independent of x , then $a^w(hD_x)$ is a Fourier series multiplier modulo $O(h^\infty)$: for each N ,

$$\text{if } u(x) = \sum_{j \in \mathbb{Z}} u_j e^{ijx}, \text{ then } a(hD_x)u(x) = \sum_{j \in \mathbb{Z}} a(hj)u_j e^{ijx} + O_{H_h^N}(h^\infty)\|u\|_{L^2}. \quad (1.6.5)$$

In the next three propositions, we assume that $P(h) \in \Psi^m$ and $P(h) = p^w(x, hD_x) + O_{\Psi^{l:\text{skds-elliptic}m-1}}(h)$, where $p(x, \xi) \in S^m$.

Proposition 1.6.1. (*Elliptic estimate*) *Suppose that the function $\chi \in S^0$ is chosen so that $|p| \geq \langle \xi \rangle^m / C > 0$ on $\text{supp } \chi$ for some h -independent constant C . Also, assume that either the set $\text{supp } \chi$ or its complement is precompact. Then there exists a constant C_1 such that for each $u \in H_h^m$,*

$$\|\chi^w(x, hD_x)u\|_{H_h^m} \leq C_1\|P(h)u\|_{L^2} + O(h^\infty)\|u\|_{L^2}. \quad (1.6.6)$$

Proof. The proof follows the standard parametrix construction. We find a sequence of symbols $q_j(x, \xi; h) \in S^{-m-j}$, $j \geq 0$, such that for

$$Q_N(h) = \sum_{0 \leq j \leq N} h^j q_j^w(x, hD_x),$$

we get

$$(Q_N(h)P(h) - 1)\chi^w(x, hD_x) = O_{\Psi^{-N-1}}(h^{N+1}); \quad (1.6.7)$$

applying this operator equation to u , we prove the proposition.

We can take any $q_0 \in \Psi^{-m}$ such that $q_0 = p^{-1}$ near $\text{supp } \chi$; such a symbol exists under our assumptions. The rest of q_j can be constructed by induction using the equation (1.6.7). \square

⁴We write $A(h) = O_X(h^k)$ for some Fréchet space X , if for each seminorm $\|\cdot\|_X$ of X , there exists a constant C such that $\|A(h)\|_X \leq Ch^k$. We write $A(h) = O_X(h^\infty)$ if $A(h) = O_X(h^k)$ for all k .

Proposition 1.6.2. (*Gårding inequalities*) Suppose that $\chi \in C_0^\infty(\mathbb{R}^2)$.

1. If $\operatorname{Re} p \geq 0$ near $\operatorname{supp} \chi$, then there exists a constant C such that for every $u \in L^2$,

$$\operatorname{Re}(P(h)\chi^w u, \chi^w u) \geq -Ch\|\chi^w u\|_{L^2}^2 - O(h^\infty)\|u\|_{L^2}^2. \quad (1.6.8)$$

2. If $\operatorname{Re} p \geq 2\varepsilon > 0$ near $\operatorname{supp} \chi$ for some constant $\varepsilon > 0$, then for h small enough and every $u \in L^2$,

$$\operatorname{Re}(P(h)\chi^w u, \chi^w u) \geq \varepsilon\|\chi^w u\|_{L^2}^2 - O(h^\infty)\|u\|_{L^2}^2. \quad (1.6.9)$$

Proof. 1. Take $\chi_1 \in C_0^\infty(\mathbb{R}^2; \mathbb{R})$ such that $\chi_1 = 1$ near $\operatorname{supp} \chi$, but $\operatorname{Re} p \geq 0$ near $\operatorname{supp} \chi_1$. Then, apply the standard sharp Gårding inequality [137, Theorem 4.24] to the operator $\chi_1^w P(h)\chi_1^w$ and the function $\chi^w u$, and use (1.6.2).

2. Apply part 1 of this proposition to the operator $P(h) - 2\varepsilon$. \square

Proposition 1.6.3. (*Exponentiation of pseudodifferential operators*) Assume that $G \in C_0^\infty(\mathbb{R}^2)$, $s \in \mathbb{R}$, and define the operator $e^{sG^w} : L^2 \rightarrow L^2$ as

$$e^{sG^w} = \sum_{j \geq 0} \frac{(sG^w)^j}{j!}.$$

Assume that $|s|$ is bounded by an h -independent constant. Then:

1. $e^{sG^w} \in \Psi^0$ is a pseudodifferential operator.
2. $e^{sG^w} P(h)e^{-sG^w} = P(h) + ish(H_p G)^w + O_{L^2 \rightarrow L^2}(h^2)$.

Proof. 1. See for example [137, Theorem 8.3] (with $m(x, \xi) = 1$). The full symbol of e^{sG^w} can be recovered from the evolution equation satisfied by this family of operators; we see that it is equal to 1 outside of a compact set.

2. It suffices to differentiate both sides of the equation in s , divide them by h , and compare the principal symbols. \square

1.7 Analysis near the zero energy

In this section, we prove part 2 of Proposition 1.4.2. Take $h > 0$ such that $\operatorname{Re} \lambda = h^{-2}$. Put

$$\tilde{\mu} = h^2 \operatorname{Im} \lambda, \quad \tilde{k} = hk, \quad \tilde{\omega} = h\omega, \quad \tilde{\omega}_\pm = h\omega_\pm;$$

then (1.4.7) implies that

$$|\mu| \leq \varepsilon_r, \quad |a\tilde{k}| \leq \varepsilon_r, \quad |\tilde{\omega}| \leq \varepsilon_r, \quad |\tilde{\omega}_\pm| \leq \varepsilon_r, \quad (1.7.1)$$

where $\varepsilon_r > 0$ and h can be made arbitrarily small by choice of C_r and ψ . If P_x is the operator in (1.5.2), then $P_x = h^{-2}\tilde{P}_x$, where

$$\begin{aligned} \tilde{P}_x(h; \tilde{\omega}, \tilde{\mu}, \tilde{k}) &= h^2 D_x^2 + \tilde{V}_x(x; \tilde{\omega}, \tilde{\mu}, \tilde{k}), \\ \tilde{V}_x(x; \tilde{\omega}, \tilde{\mu}, \tilde{k}) &= (1 + i\tilde{\mu})\Delta_r - (1 + \alpha)^2((r^2 + a^2)\tilde{\omega} - a\tilde{k})^2. \end{aligned}$$

Now, we use Proposition 1.5.5. Let u be an outgoing function in the sense of Definition 1.5.2 and assume that $f = \tilde{P}_x u$ is supported in K_x . Then u satisfies (1.5.5) for $|x| > R_0$ and some functions v_\pm . Fix $x_+ > R_0$ and consider the function

$$v_1(y) = v_+(e^{-A_+(x_+ + iy)}; \omega, \lambda, k), \quad y \in \mathbb{R}. \quad (1.7.2)$$

This is a $2\pi/A_+$ -periodic function; we can think of it as a function on the circle. It follows from the differential equation satisfied by v_+ together with Cauchy-Riemann equations that $Q(h)v_1(y) = 0$, where

$$Q(h; \tilde{\omega}, \tilde{\mu}, \tilde{k}) = (-ihD_y + \tilde{\omega}_+)^2 + \tilde{V}_x(x_+ + iy; \tilde{\omega}, \tilde{\mu}, \tilde{k}).$$

Let $q(y, \eta)$ be the semiclassical symbol of Q :

$$q(y, \eta) = (-i\eta + \tilde{\omega}_+)^2 + \tilde{V}_x(x_+ + iy).$$

For small h , the function $v_1(y)$ has to be (semiclassically) microlocalized on the set $\{q = 0\}$. Since the symbol q is complex-valued, in a generic situation this set will consist of isolated points. Also, since v_1 is the restriction to a certain circle of the function v_+ , which is holomorphic inside this circle, it is microlocalized in $\{\eta \leq 0\}$. Therefore, if the equation $q(y, \eta) = 0$ has only one root with $\eta \leq 0$, then the function v_1 has to be microlocalized at this root. If furthermore \bar{q} satisfies Hörmander's hypoellipticity condition, one can obtain an asymptotic decomposition of v_1 in powers of h . We will only need a weak corollary of such decomposition; here is a self-contained proof of the required estimates:

Proposition 1.7.1. *Assume that $x_+ > R_0$ is chosen so that:*

- *the equation $q(y, \eta) = 0$, $y \in \mathbb{S}^1$, has exactly one root (y_0, η_0) such that $\eta_0 < 0$;*
- *the equation $q(y, \eta) = 0$ has no roots with $\eta = 0$;*
- *the condition $i\{q, \bar{q}\} < 0$ is satisfied at (y_0, η_0) ;*
- $\text{Re}(\eta_0 + i\tilde{\omega}_+) < 0$.

(If all of the above hold, we say that we have vertical control at x_+ and (y_0, η_0) is called the microlocalization point.) Let $\eta(y)$ be the family of solutions to $q(y, \eta(y)) = 0$ with $\eta(y_0) = \eta_0$. Then for each N , each $\chi(y, \eta) \in C_0^\infty$ that is equal to 1 near (y_0, η_0) , and h small enough, we have

$$\|(1 - \chi^w(y, hD_y))v_1\|_{H_h^N} = O(h^\infty)\|v_1\|_{L^2}, \quad (1.7.3)$$

$$\|(hD_y - \eta(y))v_1\|_{H_h^N} = O(h)\|v_1\|_{L^2}, \quad (1.7.4)$$

$$\|v_1\|_{L^2} \leq Ch^{1/4}|v_1(y_0)|, \quad (1.7.5)$$

$$|(hD_y - \eta_0)v_1(y_0)| \leq Ch^{1/2}\|v_1\|_{L^2}, \quad (1.7.6)$$

$$\text{Re} \left(\frac{h\partial_x u_+(x_+ + iy_0)}{u_+(x_+ + iy_0)} \right) \leq -\frac{1}{C} < 0. \quad (1.7.7)$$

Similar statements are true for u_+ replaced by u_- , with the opposite inequality sign in (1.7.7).

Proof. (1.7.3): We know that

$$\inf\{\eta \mid q(y, \eta) = 0, (y, \eta) \neq (y_0, \eta_0)\} > 0.$$

Therefore, we can decompose $1 = \chi + \chi_+ + \chi_0$, where χ_+ depends only on the η variable, is supported in $\{\eta > 0\}$, and is equal to 1 for large positive η and near every root of the equation $q(y, \eta) = 0$ with $\eta > 0$. Since v_+ is holomorphic at zero, its Taylor series provides the Fourier series for v_1 ; it then follows from (1.6.5) that

$$\|\chi_+^w(y, hD_y)v_1\|_{H_h^N} = O(h^\infty)\|v_1\|_{L^2}.$$

Next, the symbol q is elliptic near $\text{supp } \chi_0$; therefore, by Proposition 1.6.1 (whose proof applies without changes to our case), since $Q(h)v_1 = 0$, we have

$$\|\chi_0^w(y, hD_y)v_1\|_{H_h^N} = O(h^\infty)\|v_1\|_{L^2}.$$

This finishes the proof.

(1.7.4): Take a small cutoff χ as above, and factor $q = (\eta - \eta(y))q_1$, where $q_1(y, \eta)$ is nonzero near $\text{supp } \chi$. We then find a compactly supported symbol r_1 with $r_1q_1 = 1$ near $\text{supp } \chi$. Now, we have

$$\begin{aligned} \|\chi^w(y, hD_y)(r_1^w(y, hD_y)q_1^w(y, hD_y) - 1)(hD_y - \eta(y))v_1\|_{H_h^N} &= O(h)\|v_1\|_{L^2}, \\ \|(1 - \chi^w(y, hD_y))(r_1^w(y, hD_y)q_1^w(y, hD_y) - 1)(hD_y - \eta(y))v_1\|_{H_h^N} &= O(h^\infty)\|v_1\|_{L^2}, \\ \|r_1^w(y, hD_y)(q_1^w(y, hD_y)(hD_y - \eta(y)) - Q(h))v_1\|_{H_h^N} &= O(h)\|v_1\|_{L^2}. \end{aligned}$$

It remains to add these up.

(1.7.5): We cut off v_1 to make it supported in a small ε -neighborhood of y_0 . Put $f = (h\partial_y - i\eta(y))v_1$; we know that $\|f\|_{L^2} \leq Ch\|v_1\|_{L^2}$. Now, put

$$\Phi(y) = \int_{y_0}^y \eta(y') dy'.$$

The condition $i\{q, \bar{q}\}|_{(y_0, \eta_0)} < 0$ is equivalent to

$$\text{Im } \partial_y \eta(y_0) > 0;$$

it follows that

$$\text{Im}(\Phi(y) - \Phi(y')) \geq \beta((y - y_0)^2 - (y' - y_0)^2) \quad (1.7.8)$$

for some $\beta > 0$, $|y - y_0| < \varepsilon$, and y' between y and y_0 . (To see that, represent the left-hand side as an integral.) Now,

$$v_1(y) = e^{i\Phi(y)/h}v_1(y_0) + h^{-1} \int_{y_0}^y e^{i(\Phi(y) - \Phi(y'))/h} f(y') dy'.$$

Let $Tf(y)$ be the second term in the sum above; it suffices to prove that

$$\|Tf\|_{L^2(y_0-\varepsilon, y_0+\varepsilon)} \leq Ch^{-1/2}\|f\|_{L^2(y_0-\varepsilon, y_0+\varepsilon)}.$$

This can be reduced to the inequalities

$$\begin{aligned} \sup_{0 \leq y-y_0 < \varepsilon} \int_{y_0}^y |e^{i(\Phi(y)-\Phi(y'))/h}| dy' &= O(h^{1/2}), \\ \sup_{0 \leq y'-y_0 < \varepsilon} \int_{y'}^{y_0+\varepsilon} |e^{i(\Phi(y)-\Phi(y'))/h}| dy &= O(h^{1/2}). \end{aligned}$$

and similar inequalities for the case $y, y' < y_0$. We now use (1.7.8); after a change of variables, it suffices to prove that

$$\sup_{y>0} \int_0^y e^{(y')^2-y^2} dy' < \infty, \quad \sup_{y'>0} \int_{y'}^\infty e^{(y')^2-y^2} dy < \infty.$$

To prove the first of these inequalities, make the change of variables $y' = ys$; then the integral becomes

$$\int_0^1 ye^{y^2(s^2-1)} ds.$$

However, $ye^{y^2(s^2-1)} \leq C(1-s^2)^{-1/2}$, and the integral of the latter converges.

After the change of variables $y = y' + s$, the integral of the second inequality above becomes

$$\int_0^\infty e^{-2y's-s^2} ds.$$

This can be estimated by $\int e^{-s^2} ds$.

(1.7.6): Let $\chi \in C_0^\infty(\mathbb{R}^2)$ have $\chi = 1$ near (y_0, η_0) . Combining (1.6.1) and (1.7.4) with

$$\|(1 - \chi^w(y, hD_y))(hD_y - \eta(y))v_1\|_{L^\infty} = O(h^\infty)\|v_1\|_{L^2},$$

we get $\|(hD_y - \eta(y))v_1\|_{L^\infty} = O(h^{1/2})\|v_1\|_{L^2}$; it remains to take $y = y_0$.

(1.7.7): Follows immediately from (1.7.5), (1.7.6), (1.7.2), Cauchy-Riemann equations, and the fact that $\text{Re}(\eta_0 + i\tilde{\omega}_+) < 0$. \square

If \tilde{P}_x were a semiclassical Schrödinger operator with a strictly positive potential, then a standard integration by parts argument would give us $\|u\|_{L^2} \leq C\|\tilde{P}_x u\|_{L^2}$ on any interval for each function u satisfying the condition (1.7.7) at the right endpoint of this interval and the opposite condition at its left endpoint. We now generalize this argument to our case. Assume that we have vertical control at the points x_\pm , $\pm x_\pm > R_0$, and let (y_\pm, η_\pm) be the corresponding microlocalization points. Let γ be a contour in the z plane; we say that we have *horizontal control* on γ if:

- $\gamma \cap \{|\text{Re } z| \leq R_0\} \subset \mathbb{R}$;



Figure 1.3: A contour with horizontal control.

- the endpoints of γ are $z_{\pm} = x_{\pm} + iy_{\pm}$;
- γ is given by $\text{Im } z = F(\text{Re } z)$, where F is a smooth function and $F'(x_{\pm}) = 0$;
- $\text{Re}[(1 + iF'(x))\tilde{V}_x(x + iF(x))] \geq \frac{1}{C_1} > 0$ for all x .

Now, let u be as in the beginning of this section and define $u_{\gamma}(x)$, $x_- \leq x \leq x_+$, by Proposition 1.5.5. Then $\tilde{P}_{\gamma}u_{\gamma} = f$, where

$$\tilde{P}_{\gamma} = \left(\frac{1}{1 + iF'(x)} hD_x \right)^2 + \tilde{V}_x(x + iF(x)).$$

If we have vertical control at the endpoints of γ , then by (1.7.7),

$$\pm \text{Re}(\overline{u_{\gamma}(x_{\pm})} h \partial_x u_{\gamma}(x_{\pm})) \leq -|u_{\gamma}(x_{\pm})|^2 / C < 0.$$

Now, assume that we have horizontal control on γ . Then we can integrate by parts to get

$$\begin{aligned} & \int_{x_-}^{x_+} \text{Re}(\overline{u_{\gamma}}(1 + iF'(x))f) dx = \int_{x_-}^{x_+} \text{Re}(\overline{u_{\gamma}} \cdot (1 + iF'(x))\tilde{P}_{\gamma}u_{\gamma}) dx \\ & = \int_{x_-}^{x_+} \text{Re} \frac{|hD_x u_{\gamma}|^2}{1 + iF'(x)} dx + \int_{x_-}^{x_+} \text{Re}[(1 + iF'(x))\tilde{V}_x(x + iF(x))] \cdot |u_{\gamma}|^2 dx \\ & \quad - h^2 \text{Re}(\overline{u_{\gamma}} \partial_x u_{\gamma})|_{x=x_-}^{x_+} \geq \frac{1}{C_1} (\|u_{\gamma}\|_{L^2}^2 + h(|u_{\gamma}(x_+)|^2 + |u_{\gamma}(x_-)|^2)). \end{aligned} \quad (1.7.9)$$

Therefore,

$$\|u_{\gamma}\|_{L^2} \leq C \|f\|_{L^2}.$$

It follows that the operator R_x from (1.5.8) is correctly defined and

$$\|1_{K_x} R_x 1_{K_x}\|_{L^2 \rightarrow L^2} \leq Ch^2,$$

This proves the estimate (1.4.8) under the assumptions made above.

We now prove (1.4.9). We concentrate on the estimate on K_+ ; the case of K_- is considered in a similar fashion. First of all, it follows from (1.7.9) that

$$|u_\gamma(x_+)| \leq Ch^{-1/2} \|f\|_{L^2}. \quad (1.7.10)$$

Now, assume that we have vertical control at every point of the interval $I_+ = [x_+, x_+ + 1]$ and let $(y(x), \eta(x))$, $x \in I_+$, be the corresponding microlocalization points. Let $v_x(z) = e^{-i\omega_+ z} u(z)$ and put $v_2(x) = v_x(x + iy(x))$; then

$$|v_2(x_+)| \leq Ce^{\text{Im}(\omega_+ z_+)} |u_\gamma(x_+)|. \quad (1.7.11)$$

Now, by Proposition 1.7.1, we have

$$|h\partial_x \ln |v_2(x)| - \eta(x)| \leq Ch^{3/4}, \quad x \in I_+. \quad (1.7.12)$$

Integrating (1.7.12) and combining it with (1.7.10) and (1.7.11), we see that if

$$\text{Im}(\tilde{\omega}_+ z_+) + \int_{x_+}^{x_++1} \eta(x) dx < -2\delta_0 \quad (1.7.13)$$

for some $\delta_0 > 0$, then $|v_2(x_+ + 1)| \leq Ce^{-\delta_0/h} \|f\|_{L^2}$. Next, $v_2(x_+ + 1)$ is the value of v at the microlocalization point; therefore, by Proposition 1.7.1 and (1.6.1),

$$\sup_{y \in \mathbb{R}} |v_x(x_+ + 1 + iy)| \leq Ch^{-1/4} e^{-\delta_0/h} \|f\|_{L^2}.$$

Finally, recall that $v_x(z) = v_w(e^{-A_+ z})$, where the function $v_w(w)$ is holomorphic inside the disc $B_w = \{|w| \leq e^{-A_+(x_++1)}\}$. The change of variables $w \rightarrow r$ is holomorphic by Proposition 1.5.1; let K_+^w be the image of K_+ under this change of variables. If δ_{r_0} is small enough, then K_+^w lies in the interior of B_w ; then by the maximum principle and Cauchy estimates on derivatives, we can estimate $\|v_w\|_{C^N(K_+^w)}$ for each N by $O(h^\infty) \|f\|_{L^2}$. This completes the proof of (1.4.9) if the conditions above are satisfied.

To prove part 2 of Proposition 1.4.2, it remains to establish both vertical and horizontal control in our situation:

Proposition 1.7.2. *Assume that $\delta_r > 0$. Then there exist ε_r and x_\pm , $\pm x_\pm > R_0$, such that under the conditions (1.7.1),*

- *we have vertical control at every point of the intervals $I_+ = [x_+, x_+ + 1]$ and $I_- = [x_- - 1, x_-]$;*
- *we have horizontal control on a certain contour γ ;*
- *the inequality (1.7.13) (and its analogue on I_-) holds.*

Proof. Let us first assume that $a\tilde{k} = \tilde{\mu} = \tilde{\omega} = 0$. Then $\tilde{\omega}_\pm = 0$ and $q(y, \eta) = -\eta^2 + \Delta_r(x_+ + iy)$. Therefore, if we choose x_+ large enough, there exists exactly one solution (y_0, η_0) to the equation $q(y, \eta) = 0$ with $\eta \leq 0$, and this solution has $y_0 = 0$. It is easy to verify that in that case we have vertical control on I_+ . Similarly one can choose the point x_- ; moreover, we can assume that $K_r \subset (x_-, x_+)$ after the change of variables $r \rightarrow x$. Next, since $\tilde{V}_x = \Delta_r$, we can take γ to be the interval $[x_-, x_+]$ of the real line. The condition (1.7.13) holds because $\eta(x) < 0$ for every x and $\tilde{\omega}_\pm = 0$.

Now, fix x_\pm as above. The parameters of our problem are a , varying in a compact set, Λ and M , both fixed, and $a\tilde{k}, \tilde{\mu}, \tilde{\omega}$. By the implicit function theorem, if the last three parameters are small enough, the (open) conditions of vertical control and the condition (1.7.13) are still satisfied, yielding y_\pm close to zero. Then one can take the contour γ defined by $\text{Im } z = F(\text{Re } z)$, where $F = 0$ near K_r , $F(x_\pm) = y_\pm$, and F is small in C^∞ . For small values of $a\tilde{k}, \tilde{\mu}, \tilde{\omega}$, we will still have horizontal control on this γ , proving the proposition. \square

1.8 Resonance free strip

In this section, we prove Theorem 1.5. First of all, by Proposition 1.4.4, it suffices to prove

Proposition 1.8.1. *Fix $\delta_r > 0$, $\varepsilon_e > 0$, and a large constant C' . Then there exist constants $a_0 > 0$ and C'' such that for*

$$\begin{aligned} |\text{Re } \lambda| + k^2 &\leq C' |\text{Re } \omega|^2, \quad |a| < a_0, \quad |\text{Re } \omega| \geq 1/C'', \\ |\text{Im } \omega| &\leq 1/C'', \quad |\text{Im } \lambda| \leq |\text{Re } \omega|/C'' \end{aligned}$$

we have

$$\|1_{K_r} R_r(\omega, \lambda, k) 1_{K_r}\|_{L^2 \rightarrow L^2} \leq C'' |\omega|^{\varepsilon_e - 1}.$$

Indeed, we take C' large enough so that $C_k^2(1 + |\omega|)^2 + L \leq C' |\omega|^2/2$; then, we put $l_1 = L$ and $l_2 = |\text{Re } \omega|/C''$.

Next, we reformulate Proposition 1.8.1 in semiclassical terms. Without loss of generality, we may assume that $\text{Re } \omega > 0$. Put $h = (\text{Re } \omega)^{-1}$ and consider the rescaled operator

$$\tilde{P}_x = h^2 P_x = h^2 D_x^2 + (\tilde{\lambda} + ih\tilde{\mu})\Delta_r - (1 + \alpha)^2((r^2 + a^2)(1 + ih\nu) - a\tilde{k})^2.$$

Here P_x is the operator in (1.5.2) and

$$\tilde{\lambda} = h^2 \text{Re } \lambda, \quad \tilde{k} = hk, \quad \tilde{\mu} = h \text{Im } \lambda, \quad \nu = \text{Im } \omega.$$

Then it suffices to prove that for h small enough and under the conditions

$$|\tilde{\lambda}| \leq C', \quad |\tilde{k}| \leq C', \quad |\tilde{\mu}| \leq 1/C'', \quad |\nu| \leq 1/C'', \quad (1.8.1)$$

for each $f(x) \in L^2 \cap \mathcal{E}'(K_x)$ and solution $u(x)$ to the equation $\tilde{P}_x u = f$ which is outgoing in the sense of Definition 1.5.2, we have

$$\|u\|_{L^2(K_x)} \leq Ch^{-1-\varepsilon_e} \|f\|_{L^2}. \quad (1.8.2)$$

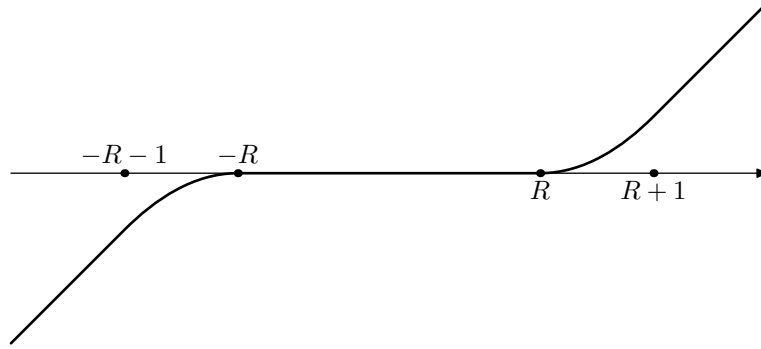

Figure 1.4: The contour used for complex scaling.

(Here K_x is the image of $K_r = (r_- + \delta_r, r_+ - \delta_r)$ under the change of variables $r \rightarrow x$.) We write $\tilde{P}_x = h^2 D_x^2 + \tilde{V}_0 + ih\tilde{V}_1$, where

$$\begin{aligned}\tilde{V}_0 &= \tilde{\lambda}\Delta_r - (1 + \alpha)^2(r^2 + a^2 - a\tilde{k})^2, \\ \tilde{V}_1 &= \tilde{\mu}\Delta_r - \nu(1 + \alpha)^2(r^2 + a^2)((r^2 + a^2)(2 + ih\nu) - 2a\tilde{k})^2.\end{aligned}$$

We note that \tilde{V}_0 is real-valued and $\|\tilde{V}_1\|_{L^\infty} \leq C/C''$ for some global constant C .

We now apply the method of complex scaling. (This method was first developed by Aguilar and Combes in [1]; see [115] and the references there for more recent developments.) Consider the contour γ in the complex plane given by $\text{Im } x = F(\text{Re } x)$, with F defined by

$$F(x) = \begin{cases} 0, & |x| \leq R; \\ F_0(x - R), & x \geq R; \\ -F_0(-x - R), & x \leq -R. \end{cases} \quad (1.8.3)$$

Here $R > R_0$ is large and $F_0 \in C_0^\infty(0, \infty)$ is a fixed function such that $F_0' \geq 0$ and $F_0'' \geq 0$ for all x and $F_0'(x) = 1$ for $x \geq 1$. (We could use a contour which forms an arbitrary fixed angle $\tilde{\theta} \in (0, \pi/2)$ with the horizontal axis for large x ; we choose the angle $\pi/4$ to simplify the formulas.) Now, let u be an outgoing solution to the equation $\tilde{P}_x u = f \in L^2 \cap \mathcal{E}'(K_x)$, as above. By Proposition 1.5.5, we can define the restriction u_γ of u to γ and $\tilde{P}_\gamma u_\gamma = f$, where

$$\tilde{P}_\gamma = \left(\frac{h}{1 + iF'(x)} D_x \right)^2 + \tilde{V}_0(x + iF(x)) + ih\tilde{V}_1(x + iF(x)).$$

Also, for a and h small enough, u_γ lies in $H^2(\mathbb{R})$. Therefore, in order to prove (1.8.2), it is enough to show that for each $u_\gamma \in H^2(\mathbb{R})$, we have

$$\|u_\gamma\|_{L^2(\mathbb{R})} \leq Ch^{-1-\varepsilon_e} \|\tilde{P}_\gamma u_\gamma\|_{L^2(\mathbb{R})}. \quad (1.8.4)$$

Let p_0 and $p_{\gamma 0}$ be the semiclassical principal symbols of \tilde{P}_x and \tilde{P}_γ :

$$\begin{aligned} p_0(x, \xi) &= \xi^2 + \tilde{V}_0(x), \\ p_{\gamma 0}(x, \xi) &= \frac{\xi^2}{(1 + iF'(x))^2} + \tilde{V}_0(x + iF(x)). \end{aligned}$$

The key property of the operator \tilde{P}_γ , as opposed to \tilde{P}_x , is ellipticity at infinity, which follows from the fact that $\tilde{V}_0(\pm\infty) = -\tilde{\omega}_{0\pm}^2$, where

$$\tilde{\omega}_{0\pm} = (1 + \alpha)(r_\pm^2 + a^2 - ak) \geq 1/C > 0$$

if a is small enough. Certain other properties of the symbol $p_{\gamma 0}$ can be derived using only the behavior of \tilde{V}_0 near infinity given by (1.5.4); we state them for a general class of potentials:

Proposition 1.8.2. *Assume that $V(x)$, $x > 0$, is a real-valued potential such that for $x > R_0$, we have $V(x) = V_+(e^{-A+x})$ for a certain constant $A_+ > 0$ and a function $V_+(w)$ holomorphic in $\{|w| < e^{-A+R_0}\}$; assume also that $V_+(0) < 0$. Let $F(x)$ be as in (1.8.3), for $R > R_0$, and put*

$$\begin{aligned} p(x, \xi) &= \xi^2 + V(x), \\ p_\gamma(x, \xi) &= \frac{\xi^2}{(1 + iF'(x))^2} + V(x + iF(x)). \end{aligned}$$

Then there exists a constant C_c such that for R large enough and $\delta > 0$ small enough,

$$\text{if } x \geq R + 1, \text{ then } |p_\gamma(x, \xi)| \geq 1/C_c > 0, \quad (1.8.5)$$

$$\text{if } |p_\gamma(x, \xi)| \leq e^{-A+R}, \text{ then } \text{Im } p_\gamma(x, \xi) \leq 0, \quad (1.8.6)$$

$$\text{if } |p_\gamma(x, \xi)| \leq \delta, \text{ then } |p(x, \xi)| \leq C_c\delta, \quad |\nabla(\text{Re } p_\gamma - p)(x, \xi)| \leq C_c\delta. \quad (1.8.7)$$

Similar facts hold if V is defined on $x < 0$ instead.

Proof. Without loss of generality, we assume that $A_+ = 1$ and $V_+(0) = -1$. First of all, if $x \geq R + 1$, then

$$p_\gamma(x, \xi) = -i\xi^2/2 + V(x + iF(x)) = -i\xi^2/2 - 1 + O(e^{-R}).$$

For R large enough, we then get $|p_\gamma(x, \xi)| \geq 1/2$, thus proving (1.8.5).

For the rest of the proof, we may assume that $R \leq x \leq R+1$. Then, since F'_0 is increasing, we get $0 \leq F(x) \leq F'(x)$. Suppose that $|p_\gamma(x, \xi)| \leq \delta$; then

$$\begin{aligned} \frac{\xi^2}{(1 + iF'(x))^2} &= -V(x + iF(x)) + O(\delta) \\ &= -V(x)(1 + O(\delta + e^{-R}F(x))) = 1 + O(\delta + e^{-R}). \end{aligned} \quad (1.8.8)$$

Taking the arguments of both sides, we get

$$F'(x) \leq C(\delta + e^{-R}F(x)) \leq C\delta + Ce^{-R}F'(x).$$

Then for R large enough,

$$|p_\gamma(x, \xi)| \leq \delta \rightarrow F'(x) \leq C\delta.$$

This proves (1.8.7), if we note that F'' is bounded and

$$\operatorname{Re} p_\gamma(x, \xi) - p(x, \xi) = \xi^2 G_1(F'(x)^2) + G_2(F(x), x)$$

for certain smooth functions G_1 and G_2 that are equal to zero at $F' = 0$ and $F = 0$, respectively.

Now, putting $\delta = e^{-R}$ and taking the arguments and then the absolute values of both sides of (1.8.8), we get for $|p_\gamma| \leq \delta$,

$$F'(x) = O(e^{-R}), \quad \xi^2 = 1 + O(e^{-R}).$$

Therefore,

$$\operatorname{Im} p_\gamma(x, \xi) = -2F'(x) + O(e^{-R}(F(x) + F'(x))) = F'(x)(-2 + O(e^{-R})),$$

which proves (1.8.6). □

Now, we study the trapping properties of the Hamiltonian flow of p_0 at the zero energy:

Proposition 1.8.3. *There exist constants C_V and δ_V such that for a small enough and every $\tilde{\lambda}$, \tilde{k} satisfying (1.8.1), at least one of the three dynamical cases below holds:*

- (1) $\tilde{V}_0 \leq -\delta_V$ everywhere;
- (2) $\{|\tilde{V}_0| \leq \delta_V\} = [x_1, x_2] \sqcup [x_3, x_4]$, where $-C_V \leq x_1 < x_2 < x_3 < x_4 \leq C_V$ and $\tilde{V}'_0 \geq 1/C_V$ on $[x_1, x_2]$, $\tilde{V}'_0 \leq -1/C_V$ on $[x_3, x_4]$;
- (3) $\{\tilde{V}_0 \geq -\delta_V\} = [x_1, x_2]$ with $|x_j| \leq C_V$, $\tilde{V}''_0 \leq -1/C_V$ on $[x_1, x_2]$.

Proof. First of all, if $\tilde{\lambda}$ is small enough or $\tilde{\lambda} < 0$, then we have $\tilde{V}_0 < 0$ everywhere and therefore case (1) holds for δ_V small enough. Therefore, we may assume that $1/C \leq \tilde{\lambda} \leq C$ for some constant C . Now, we write

$$\begin{aligned} \tilde{V}_0(x) &= G_V(r)(F_V(r) - \tilde{\lambda}^{-1}), \\ G_V(r) &= \tilde{\lambda}(1 + \alpha)^2(r^2 + a^2 - a\tilde{k})^2, \\ F_V(r) &= \frac{\Delta_r}{(1 + \alpha)^2(r^2 + a^2 - a\tilde{k})^2}. \end{aligned}$$

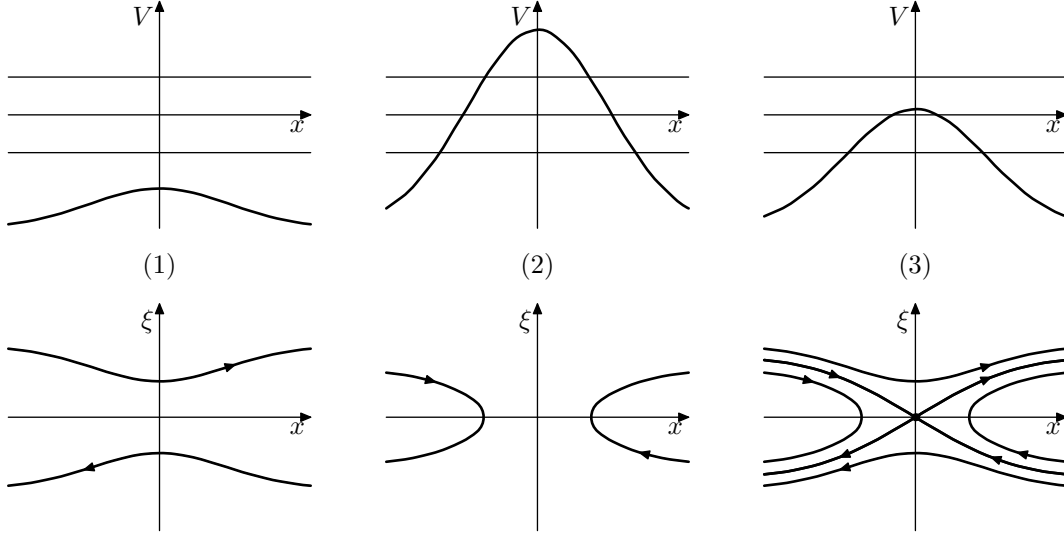

Figure 1.5: Three cases for the potential \tilde{V}_0 and its Hamiltonian flow near the zero energy. The horizontal lines correspond to $\tilde{V}_0 = \pm\delta_V$.

Note that $1/C \leq G_V(r) \leq C$ for a small enough, some constant C , and all r . As for F_V , there exists $\varepsilon > 0$ such that for a small enough, $\partial_r F_V(r) \geq 1/C > 0$ for $r \leq 3M - \varepsilon$, $\partial_r F_V(r) \leq -1/C < 0$ for $r \geq 3M + \varepsilon$, and $\partial_r^2 F_V(r) \leq -1/C < 0$ for $|r - 3M| \leq \varepsilon$. Indeed, this is true for $a = 0$ and follows for small a by a perturbation argument. Let $r_0 \in [3M - \varepsilon, 3M + \varepsilon]$ be the point where F_V achieves its maximal value. Take small $\delta_1 > 0$; then we have one of the following three cases, each of which in turn implies the corresponding case in the statement of this proposition:

- (1) $F_V(r_0) - \tilde{\lambda}^{-1} \leq -\delta_1$. Then $\tilde{V}_0(x) < -\delta_V$ for all x and $\delta_V > 0$ small enough.
- (2) $F_V(r_0) - \tilde{\lambda}^{-1} \geq \delta_1$. Then for $\delta_2 < \delta_1/2$, $\{|F_V - \tilde{\lambda}^{-1}| \leq \delta_2\} = [x_1, x_2] \sqcup [x_3, x_4]$, where $x_2 < x_3$, x_j are bounded by a global constant (since $\tilde{\lambda}$ is bounded from above), and $\partial_r F_V(r) > 1/C_\delta > 0$ for $x \in [x_1, x_2]$, $\partial_r F_V(r) < -1/C_\delta < 0$ for $x \in [x_3, x_4]$. Here C_δ is a constant depending on δ_1 , but not on δ_2 . It follows that for δ_2 small enough depending on δ_1 , we have $\tilde{V}'_0(x) > 0$ for $x \in [x_1, x_2]$ and $\tilde{V}'_0(x) < 0$ for $x \in [x_3, x_4]$; also, for δ_V small enough, we have $\{|\tilde{V}_0| \leq \delta_V\} \subset [x_1, x_2] \sqcup [x_3, x_4]$.
- (3) $|F_V(r_0) - \tilde{\lambda}^{-1}| < \delta_1$. Then $\{F_V - \tilde{\lambda}^{-1} > -\delta_1\} = [x_1, x_2]$ with $\partial_r^2 F_V(r) < -1/C < 0$ for $x \in [x_1, x_2]$. For δ_1 small enough, we then get $\tilde{V}_0'' < -1/C < 0$ for $x \in [x_1, x_2]$, and for δ_V small enough, we have $\{\tilde{V}_0 \geq -\delta_V\} \subset [x_1, x_2]$. \square

We are now ready to prove (1.8.4) and, therefore, Theorem 1.5. Fix R large enough so that Proposition 1.8.2 holds. The first two cases in Proposition 1.8.3 are nontrapping; it follows that there exists an escape function $G \in C_0^\infty(\mathbb{R}^2)$ such that $H_{p_0}G < 0$ on $\{|p_0| \leq$

$\delta_V/2\} \cap \{|x| \leq R+2\}$. In the third case, we have hyperbolic trapping with the trapped set consisting of a single point $(x_0, 0)$, where x_0 is the point where \tilde{V}_0 achieves its maximal value; therefore, there still exists an escape function $G \in C_0^\infty(\mathbb{R}^2)$ such that $H_{p_0}G \leq 0$ on $\{|p_0| \leq \delta_V/2\} \cap \{|x| \leq R+2\}$ and $H_{p_0}G < 0$ on $\{|p_0| \leq \delta_V/2\} \cap \{|x| \leq R+2\} \setminus U(x_0, 0)$, where U is a neighborhood of $(x_0, 0)$ which can be made arbitrarily small by the choice of G (see [56, Proposition A.6]). Now, given Proposition 1.8.2, we can choose $\delta_0 > 0$ such that

$$\operatorname{Im} p_{\gamma_0} \leq 0 \text{ on } \{|p_{\gamma_0}| \leq \delta_0\} \quad (1.8.9)$$

and for cases (1) and (2) of Proposition 1.8.3, we have

$$H_{\operatorname{Re} p_{\gamma_0}} G \leq -1/C < 0 \text{ on } \{|p_{\gamma_0}| \leq \delta_0\}, \quad (1.8.10)$$

and for case (3) of Proposition 1.8.3, we have

$$\begin{aligned} H_{\operatorname{Re} p_{\gamma_0}} G &\leq 0 \text{ on } \{|p_{\gamma_0}| \leq \delta_0\}, \\ H_{\operatorname{Re} p_{\gamma_0}} G &\leq -1/C < 0 \text{ on } \{|p_{\gamma_0}| \leq \delta_0\} \setminus U(x_0, 0). \end{aligned} \quad (1.8.11)$$

Armed with these inequalities, we can handle the nontrapping cases even without requiring that μ and ν be small. The statement below follows the method initially developed in [85] and is a special case of the results in [34, Chapter 6]; however, we choose to present the proof in our simple case:

Proposition 1.8.4. *Assume that either case (1) or case (2) of Proposition 1.8.3 holds. Then for λ and \tilde{k} bounded by C' , $\tilde{\mu}$ and ν bounded by some constant, and h small enough, we have*

$$\|u_\gamma\|_{L^2} \leq Ch^{-1} \|\tilde{P}_\gamma u_\gamma\|_{L^2} \quad (1.8.12)$$

for each $u_\gamma \in H^2(\mathbb{R})$.

Proof. Take $\chi \in C_0^\infty(\mathbb{R}^2)$ such that $\operatorname{supp} \chi \subset \{|p_{\gamma_0}| < \delta_0\}$, but $\chi = 1$ near $\{p_{\gamma_0} = 0\}$. Next, take $s > 0$, to be chosen later, and put

$$\tilde{P}_{\gamma,s} = e^{sG^w} \tilde{P}_\gamma e^{-sG^w}, \quad u_{\gamma,s} = e^{sG^w} \chi^w u_\gamma.$$

Take $\chi_1 \in C_0^\infty(\mathbb{R}^2)$ supported in $\{|p_{\gamma_0}| < \delta_0\}$, but such that $\chi_1 = 1$ near $\operatorname{supp} \chi$. Then by part 1 of Proposition 1.6.3 and (1.6.2),

$$\|(1 - \chi_1^w) u_{\gamma,s}\| = O(h^\infty) \|u_\gamma\|. \quad (1.8.13)$$

(In the proof of the current proposition, as well as the next one, we only use L^2 norms.) Also, for some s -dependent constant C ,

$$C^{-1} \|\chi^w u_\gamma\| \leq \|u_{\gamma,s}\| \leq C \|u_\gamma\|.$$

Now, by part 2 of Proposition 1.6.3, we have

$$\tilde{P}_{\gamma,s} = \tilde{P}_{\gamma,0} + ihV_1 + ish(H_{p_{\gamma,0}}G)^w + O(h^2).$$

Here $\tilde{P}_{\gamma,0}$ is the principal part of \tilde{P}_γ (without V_1) and the constant in $O(h^2)$ depends on s . We then have

$$\begin{aligned} \operatorname{Im}(\tilde{P}_{\gamma,s}\chi_1^w u_{\gamma,s}, \chi_1^w u_{\gamma,s}) &= \operatorname{Im}(\tilde{P}_{\gamma,0}\chi_1^w u_{\gamma,s}, \chi_1^w u_{\gamma,s}) + h \operatorname{Re}(V_1\chi_1^w u_{\gamma,s}, \chi_1^w u_{\gamma,s}) \\ &\quad + sh((H_{\operatorname{Re}p_{\gamma,0}}G)^w \chi_1^w u_{\gamma,s}, \chi_1^w u_{\gamma,s}) + O(h^2)\|\chi_1^w u_{\gamma,s}\|^2. \end{aligned}$$

By (1.8.9) and part 1 of Proposition 1.6.2,

$$\operatorname{Im}(\tilde{P}_{\gamma,0}\chi_1^w u_{\gamma,s}, \chi_1^w u_{\gamma,s}) \leq Ch\|\chi_1^w u_{\gamma,s}\|^2 + O(h^\infty)\|u_\gamma\|^2.$$

Next, by (1.8.10) and part 2 of Proposition 1.6.2,

$$((H_{\operatorname{Re}p_{\gamma,0}}G)^w \chi_1^w u_{\gamma,s}, \chi_1^w u_{\gamma,s}) \leq -C^{-1}\|\chi_1^w u_{\gamma,s}\|^2 + O(h^\infty)\|u_\gamma\|^2.$$

Adding these up, we get

$$\operatorname{Im}(\tilde{P}_{\gamma,s}\chi_1^w u_{\gamma,s}, \chi_1^w u_{\gamma,s}) \leq -h(C_1^{-1}s - C_1 - O(h))\|\chi_1^w u_{\gamma,s}\|^2 + O(h^\infty)\|u_\gamma\|^2.$$

Here the constants in $O(\cdot)$ depend on s , but the constant C_1 does not. Therefore, if we choose s large enough and h -independent, then for small h we have the estimate

$$\|\chi_1^w u_{\gamma,s}\|^2 \leq Ch^{-1}\|\tilde{P}_{\gamma,s}\chi_1^w u_{\gamma,s}\| \cdot \|\chi_1^w u_{\gamma,s}\| + O(h^\infty)\|u_\gamma\|^2.$$

Together with (1.8.13), this gives

$$\|\chi^w u_\gamma\|^2 \leq Ch^{-1}\|\tilde{P}_\gamma u_\gamma\| \cdot \|u_\gamma\| + Ch^{-1}\|[\tilde{P}_\gamma, \chi^w]u_\gamma\| \cdot \|u_\gamma\| + O(h^\infty)\|u_\gamma\|^2.$$

Applying Proposition 1.6.1 to estimate $(1 - \chi^w)u_\gamma$ and the commutator term above, we get the estimate (1.8.12). \square

Remark. The method described above can actually be used to obtain a *logarithmic* resonance free region; however, since we expect the resonances generated by trapping to lie asymptotically on a lattice as in [103], we only go a fixed amount deep into the complex plane.

The third case in Proposition 1.8.3 is where trapping occurs, and we analyse it as in [132]: (See also [18] for a different method of solving the same problem.)

Proposition 1.8.5. *Assume that case (3) in Proposition 1.8.3 holds, and fix $\varepsilon_e > 0$. Then for $\tilde{\lambda}$ and \tilde{k} bounded by C' and for $\tilde{\mu}, \nu, h$ small enough, we have*

$$\|u_\gamma\|_{L^2} \leq Ch^{-1-\varepsilon_e}\|\tilde{P}_\gamma u_\gamma\|_{L^2} \tag{1.8.14}$$

for each $u_\gamma \in H^2(\mathbb{R})$.

Proof. First, we establish [132, Lemma 4.1] in our case. Let x_0 be the point where \tilde{V}_0 achieves its maximum value. We may assume that $|p_0(x_0, 0)| = |\tilde{V}_0(x_0)| < \delta_0/2$; otherwise, we are in one of the two nontrapping cases. Put

$$\tilde{\xi}(x) = \operatorname{sgn}(x - x_0) \sqrt{\tilde{V}_0(x_0) - \tilde{V}_0(x)};$$

since $\tilde{V}_0''(x_0) < 0$, it is a smooth function. Then, define the functions $\varphi_{\pm}(x, \xi) = \xi \mp \tilde{\xi}(x)$. We have

$$H_{p_0} \varphi_{\pm}(x, \xi) = \mp c(x, \xi) \varphi_{\pm}(x, \xi),$$

where $c(x, \xi) = 2\partial_x \tilde{\xi}(x)$ is greater than zero near the trapped point $(x_0, 0)$. Also, $\{\varphi_+, \varphi_-\} = c(x, \xi)$. Next, take $\tilde{h} > h$ and large $C_0 > 0$, let $\chi_0 \geq 0$ be supported in a small neighborhood of $(x_0, 0)$ with $\chi_0 = 1$ near this point, and define the modified escape function [132, (4.6)]

$$G_1(x, \xi) = -\chi_0(x, \xi) \log \frac{\varphi_-^2(x, \xi) + h/\tilde{h}}{\varphi_+^2(x, \xi) + h/\tilde{h}} + C_0 \log(1/h) G(x, \xi).$$

Here G is an escape function satisfying (1.8.11). We can write

$$\begin{aligned} H_{\operatorname{Re} p_{\gamma, 0}} G_1 &= -2\chi_0 c \left(\frac{\varphi_-^2}{\varphi_-^2 + h/\tilde{h}} + \frac{\varphi_+^2}{\varphi_+^2 + h/\tilde{h}} \right) \\ &\quad - (H_{p_0} \chi_0) \log \frac{\varphi_-^2 + h/\tilde{h}}{\varphi_+^2 + h/\tilde{h}} + C_0 \log(1/h) H_{\operatorname{Re} p_{\gamma, 0}} G(x, \xi). \end{aligned} \tag{1.8.15}$$

Take χ_1 supported in $\{|p_{\gamma, 0}| < \delta_0\}$, but equal to 1 near $\{p_{\gamma, 0} = 0\}$. Then one can use the uncertainty principle [132, §4.2] to show that if χ_2 is supported inside $\{\chi_0 = 1\}$, but $\chi_2 = 1$ near $(x_0, 0)$, then for each $v \in L^2$,

$$\begin{aligned} ((H_{\operatorname{Re} p_{\gamma, 0}} G_1)^w \chi_1^w v, \chi_1^w v) &\leq (-C^{-1} \tilde{h} + O(\tilde{h}^2)) \|\chi_2^w v\|^2 + O(\log(1/h)) \|(1 - \chi_2^w) \chi_1^w v\|^2 \\ &\quad - C_0 C^{-1} \log(1/h) \|(1 - \chi_2^w) \chi_1^w v\|^2 + O(C_0 h \log(1/h)) \|\chi_1^w v\|^2 + O(h^\infty) \|v\|^2 \\ &\leq -(C^{-1} \tilde{h} - O(\tilde{h}^2 + C_0 h \log(1/h))) \|\chi_2^w v\|^2 \\ &\quad - (C_0 C^{-1} \log(1/h) - O(C_0 h \log(1/h) + \log(1/h))) \|(1 - \chi_2^w) \chi_1^w v\|^2 + O(h^\infty) \|v\|^2. \end{aligned}$$

If we fix C_0 large enough and \tilde{h} small enough and assume that h small enough, then

$$((H_{\operatorname{Re} p_{\gamma, 0}} G_1)^w \chi_1^w v, \chi_1^w v) \leq -C^{-1} \log(1/h) \|(1 - \chi_2^w) \chi_1^w v\|^2 - C^{-1} \tilde{h} \|\chi_1^w v\|^2 + O(h^\infty) \|v\|^2.$$

Next, we conjugate by exponential pseudodifferential weights. First of all, one can prove that

$$\|G_1^w\|_{L^2 \rightarrow L^2} \leq C \log(1/h);$$

therefore,

$$\|e^{sG_1^w}\|_{L^2 \rightarrow L^2} \leq h^{-C|s|}.$$

Let χ be supported in $\{\chi_1 = 1\}$, but $\chi = 1$ near $\{p_{\gamma 0} = 0\}$, and

$$P_{\gamma,s} = e^{sG_1^w} P_\gamma e^{-sG_1^w}, \quad u_{\gamma,s} = e^{sG_1^w} \chi^w u_\gamma;$$

then [132, §4.3]

$$P_{\gamma,s} = P_\gamma + ish(H_{p_{\gamma 0}} G_1)^w + O(s^2 \tilde{h} h + sh^{3/2} \tilde{h}^{3/2} + h^2).$$

Therefore, since $\text{Im } p_{\gamma 0} = 0$ near $\text{supp } \chi_2$,

$$\begin{aligned} & \text{Im}(\tilde{P}_{\gamma,s} \chi_1^w u_{\gamma,s}, \chi_1^w u_{\gamma,s}) = \text{Im}(\tilde{P}_{\gamma 0} \chi_1^w u_{\gamma,s}, \chi_1^w u_{\gamma,s}) + h \text{Re}(V_1 \chi_1^w u_{\gamma,s}, \chi_1^w u_{\gamma,s}) \\ & + sh \text{Re}((H_{\text{Re } p_{\gamma 0}} G_1)^w \chi_1^w u_{\gamma,s}, \chi_1^w u_{\gamma,s}) + O(s^2 h \tilde{h} + sh^{3/2} \tilde{h}^{3/2} + h^2) \|\chi_1^w u_{\gamma,s}\|^2 \\ & \leq O(h) \|(1 - \chi_2^w) \chi_1^w u_{\gamma,s}\|^2 + h \|V_1\|_{L^\infty} \|\chi_1^w u_{\gamma,s}\|^2 - C^{-1} sh \log(1/h) \|(1 - \chi_2^w) \chi_1^w u_{\gamma,s}\|^2 \\ & - C^{-1} sh \tilde{h} \|\chi_1^w u_{\gamma,s}\|^2 + O(s^2 h \tilde{h} + sh^{3/2} \tilde{h}^{3/2} + h^2) \|\chi_1^w u_{\gamma,s}\|^2 + O(h^\infty) \|u_\gamma\|^2. \end{aligned}$$

Here $\tilde{P}_{\gamma 0}$ is the principal part of \tilde{P}_γ , as before. If we choose s small enough independently of h , then for small h ,

$$\begin{aligned} \text{Im}(\tilde{P}_{\gamma,s} \chi_1^w u_{\gamma,s}, \chi_1^w u_{\gamma,s}) & \leq -C_1 sh \log(1/h) \|(1 - \chi_2^w) \chi_1^w u_{\gamma,s}\|^2 \\ & - h(C^{-1} s \tilde{h} - \|V_1\|_{L^\infty}) \|\chi_1^w u_{\gamma,s}\|^2 + O(h^\infty) \|u_\gamma\|^2. \end{aligned}$$

Now, $\|V_1\|_{L^\infty}$ can be made very small by choosing $\tilde{\mu}$ and ν small enough. Then, we get

$$\|\chi^w u_\gamma\|^2 \leq Ch^{-1-Cs} \|u_\gamma\| \cdot \|P_\gamma \chi^w u_\gamma\| + O(h^\infty) \|u_\gamma\|^2.$$

By proceeding as in the end of Proposition 1.8.4, we get (1.8.14), provided that s is small enough. \square

Chapter 2

Asymptotic distribution of resonances for Kerr–de Sitter black holes

2.1 Introduction

Quasi-normal modes (QNMs) of black holes are a topic of continued interest in theoretical physics: from the classical interpretation as ringdown of gravitational waves [21] to the recent investigations in the context of string theory [74]. The ringdown plays a role in experimental projects aimed at the detection of gravitational waves, such as LIGO [3]. See [79] for an overview of the vast physics literature on the topic and [13, 135] for some more recent developments.

In this chapter we consider the Kerr–de Sitter model of a rotating black hole and assume that the speed of rotation a is small; for $a = 0$, one gets the stationary Schwarzschild–de Sitter black hole. The de Sitter model corresponds to assuming that the cosmological constant Λ is positive, which is consistent with the current Lambda-CDM standard model of cosmology.

A rigorous definition of quasi-normal modes for Kerr–de Sitter black holes was given using the scattering resolvent in Chapter 1. In Theorem 2.1 below we give an asymptotic description of QNMs in a band of any fixed width, that is, for any bounded decay rate. The result confirms the heuristic analogy with the Zeeman effect: the high multiplicity modes for the Schwarzschild black hole split.

Theorem 2.2 confirms the standard interpretation of QNMs as complex frequencies of exponentially decaying gravitational waves; namely, we show that the solutions of the scalar linear wave equation in the Kerr–de Sitter background can be expanded in terms of QNMs.

In the mathematics literature quasi-normal modes of black holes were studied by Bachelot, Motet-Bachelot, and Pravica [8, 9, 10, 99] using the methods of scattering theory. QNMs of Schwarzschild–de Sitter metric were then investigated by Sá Barreto–Zworski [103], resulting in the lattice of pseudopoles given by (2.1.3) below. For this case, Bony–Häfner [17] established polynomial cutoff resolvent estimates and a resonance expansion, Melrose–Sá Barreto–

Vasy [90] obtained exponential decay for solutions to the wave equation up to the event horizons, and Dafermos–Rodnianski [33] used physical space methods to obtain decay of linear waves better than any power of t .

Quasi-normal modes for Kerr–de Sitter were rigorously defined in Chapter 1 and exponential decay beyond event horizons was proved in [46]. Vasy [128] has recently obtained a microlocal description of the scattering resolvent and in particular recovered the results of Chapter 1 and [46] on meromorphy of the resolvent and exponential decay; see [128, Appendix] for how his work relates to Chapter 1. The crucial component for obtaining exponential decay was the work of Wunsch–Zworski [132] on resolvent estimates for normally hyperbolic trapping.

We add that there have been many papers on decay of linear waves for Schwarzschild and Kerr black holes — see [4, 16, 30, 29, 41, 42, 52, 53, 121, 122, 125] and references given there. In that case the cosmological constant is 0 (unlike in the de Sitter case, where it is positive), and the methods of scattering theory are harder to apply because of an asymptotically Euclidean infinity.

Theorem 2.1. *Fix the mass M of the black hole and the cosmological constant Λ . (See §2.2.1 for details.) Then there exists a constant $a_0 > 0$ such that for $|a| < a_0$ and each ν_0 , there exist constants C_ω, C_m^1 such that the set of quasi-normal modes ω satisfying*

$$\operatorname{Re} \omega > C_\omega, \operatorname{Im} \omega > -\nu_0 \quad (2.1.1)$$

coincides modulo $O(|\omega|^{-\infty})$ with the set of pseudopoles

$$\omega = \mathcal{F}(m, l, k), \quad m, l, k \in \mathbb{Z}, \quad 0 \leq m \leq C_m, \quad |k| \leq l. \quad (2.1.2)$$

(Since the set of QNMs is symmetric with respect to the imaginary axis, one also gets an asymptotic description for $\operatorname{Re} \omega$ negative. Also, by Theorem 1.4, all QNMs lie in the lower half-plane.) Here \mathcal{F} is a complex valued classical symbol² of order 1 in the (l, k) variables, defined and smooth in the cone $\{m \in [0, C_m], |k| \leq l\} \subset \mathbb{R}^3$. The principal symbol \mathcal{F}_0 of \mathcal{F} is real-valued and independent of m ; moreover,

$$\mathcal{F} = \frac{\sqrt{1 - 9\Lambda M^2}}{3\sqrt{3}M} [(l + 1/2) - i(m + 1/2)] + O(l^{-1}) \text{ for } a = 0, \quad (2.1.3)$$

$$(\partial_k \mathcal{F}_0)(m, \pm k, k) = \frac{(2 + 9\Lambda M^2)a}{27M^2} + O(a^2). \quad (2.1.4)$$

The pseudopoles (2.1.2) can be computed numerically; we have implemented this computation in a special case $l - |k| = O(1)$ and compared the pseudopoles with the QNMs

¹As in Chapter 1, the indices ω, m, \dots next to constants, symbols, operators, and functions do not imply differentiation.

²Here ‘symbol’ means a microlocal symbol as in for example [123, §8.1]. For the proofs, however, we will mostly use semiclassical symbols, as defined in §2.3.1.

computed by the authors of [13]. The results are described in §2.B. One should note that the quantization condition of [103] was stated up to $O(l^{-1})$ error, while Theorem 2.1 has error $O(l^{-\infty})$; we demonstrate numerically that increasing the order of the quantization condition leads to a substantially better approximation.

Another difference between (2.1.2) and the quantization condition of [103] is the extra parameter k , resulting from the lack of spherical symmetry of the problem. In fact, for $a = 0$ each pole in (2.1.3) has multiplicity $2l + 1$; for $a \neq 0$ this pole splits into $2l + 1$ distinct QNMs, each corresponding to its own value of k , the angular momentum with respect to the axis of rotation. (The resulting QNMs do not coincide for small values of a , as illustrated by (2.1.4)). In the physics literature this is considered an analogue of the Zeeman effect.

Since the proof of Theorem 2.1 only uses microlocal analysis away from the event horizons, it implies estimates on the cutoff resolvent polynomial in ω (Proposition 2.2.4). Combining these with the detailed analysis away from the trapped set (and in particular near the event horizons) by Vasy [128], we obtain estimates on the resolvent on the whole space (Proposition 2.2.3). These in turn allow a contour deformation argument leading to an expansion of waves in terms of quasinormal modes. Such expansions have a long tradition in scattering theory going back to Lax–Phillips and Vainberg — see [120] for the strongly trapping case and for references.

For Schwarzschild-de Sitter black holes a full expansion involving infinite sums over quasinormal modes was obtained in [17] (see also [23] for simpler expansions involving infinite sums over resonances). The next theorem presents an expansion of waves for Kerr–de Sitter black holes in the same style as the Bony–Häfner expansion:

Theorem 2.2. *Under the assumptions of Theorem 2.1, take $\nu_0 > 0$ such that for some $\varepsilon > 0$, every QNM ω has $|\operatorname{Im} \omega + \nu_0| > \varepsilon$. (Such ν_0 exists and can be chosen arbitrarily large, as the imaginary parts of QNMs lie within $O(|a| + l^{-1})$ of those in (2.1.3).) Then for s large enough depending on ν_0 , there exists a constant C such that every solution u to the Cauchy problem on the Kerr–de Sitter space*

$$\square_g u = 0, \quad u|_{t^*=0} = f_0 \in H^s(X_{-\delta}), \quad \partial_{t^*} u|_{t^*=0} = f_1 \in H^{s-1}(X_{-\delta}), \quad (2.1.5)$$

where $X_{-\delta} = (r_- - \delta, r_+ + \delta) \times \mathbb{S}^2$ is the space slice, t^* is the time variable, and $\delta > 0$ is a small constant (see §2.2.1 for details), satisfies for $t^* > 0$,

$$\|u(t^*) - \Pi_{\nu_0}(f_0, f_1)(t^*)\|_{H^1(X_{-\delta})} \leq C e^{-\nu_0 t^*} (\|f_0\|_{H^s} + \|f_1\|_{H^{s-1}}). \quad (2.1.6)$$

Here

$$\Pi_{\nu_0}(f_0, f_1)(t^*) = \sum_{\operatorname{Im} \widehat{\omega} > -\nu_0} e^{-it^* \widehat{\omega}} \sum_{0 \leq j < J_{\widehat{\omega}}} (t^*)^j \Pi_{\widehat{\omega}, j}(f_0, f_1); \quad (2.1.7)$$

the outer sum is over QNMs $\widehat{\omega}$, $J_{\widehat{\omega}}$ is the algebraic multiplicity of $\widehat{\omega}$ as a pole of the scattering resolvent, and $\Pi_{\widehat{\omega}, j}$ are finite rank operators mapping $H^s(X_{-\delta}) \oplus H^{s-1}(X_{-\delta}) \rightarrow C^\infty(X_{-\delta})$. Moreover, for $|\widehat{\omega}|$ large enough (that is, for all but a finite number of QNMs in the considered strip), $J_{\widehat{\omega}} = 1$, $\Pi_{\widehat{\omega}, 0}$ has rank one, and

$$\|\Pi_{\widehat{\omega}, 0}\|_{H^s(X_{-\delta}) \oplus H^{s-1}(X_{-\delta}) \rightarrow H^1(X_{-\delta})} \leq C |\widehat{\omega}|^{N-s}.$$

Here N is a constant depending on ν_0 , but not on s ; therefore, the series (2.1.7) converges in H^1 for $s > N + 2$.

The proofs start with the Teukolsky separation of variables already used in Chapter 1, which reduces our problem to obtaining quantization conditions and resolvent estimates for certain radial and angular operators (Propositions 2.2.6 and 2.2.7). These conditions are stated and used to obtain Theorems 2.1 and 2.2 in §2.2. Also, at the end of §2.2.2 we present the separation argument in the simpler special case $a = 0$, for convenience of the reader.

In the spherically symmetric case $a = 0$, the angular problem is the eigenvalue problem for the Laplace–Beltrami operator on the round sphere. For $a \neq 0$, the angular operator P_θ is not selfadjoint; however, in the semiclassical scaling it is an operator of real principal type with completely integrable Hamiltonian flow. We can then use some of the methods of [65] to obtain a microlocal normal form for $h^2 P_\theta$; since our perturbation is $O(h)$, we are able to avoid using analyticity of the coefficients of P_θ . The quantization condition we get is global, similarly to [130]. The proof is contained in §2.4; it uses various tools from semiclassical analysis described in §2.3.

To complete the proof of the angular quantization condition, we need to extract information about the joint spectrum of $h^2 P_\theta$ and hD_φ from the microlocal normal form; for that, we formulate a Grushin problem for several commuting operators. The problem that needs to be overcome here is that existence of joint spectrum is only guaranteed by exact commutation of the original operators, while semiclassical methods always give $O(h^\infty)$ errors. This complication does not appear in [65, 66] as they study the spectrum of a single operator, nor in earlier works [22, 130] on joint spectrum of differential operators, as they use spectral theory of selfadjoint operators. Since this part of the construction can be formulated independently of the rest, we describe Grushin problems for several operators in an abstract setting in Appendix 2.A.

The radial problem is equivalent to one-dimensional semiclassical potential scattering. The principal part of the potential is real-valued and has a unique quadratic maximum; the proof of the quantization condition follows the methods developed in [27, 100, 110]. In [27], the microlocal behavior of the principal symbol near a hyperbolic critical point is studied in detail; however, only self-adjoint operators are considered and the phenomenon that gives rise to resonances in our case does not appear. The latter phenomenon is studied in [100] and [110]; our radial quantization condition, proved in §2.5, can be viewed as a consequence of [100, Theorems 2 and 4]. However, we do not compute the scattering matrix, which simplifies the calculations; we also avoid using analyticity of the potential near its maximum and formulate the quantization condition by means of real microlocal analysis instead of the action integral in the complex plane. As in [100], we use analyticity of the potential near infinity and the exact WKB method to relate the microlocal approximate solutions to the outgoing condition at infinity; however, the construction is somewhat simplified compared to [100, Sections 2 and 3] using the special form of the potential.

It would be interesting to see whether our statements still hold if one perturbs the metric,

or if one drops the assumption of smallness of a . Near the event horizons, we rely on §1.7, which uses a perturbation argument (thus smallness of a) and analyticity of the metric near the event horizons. Same applies to §2.5.2 of the present chapter; the exact WKB construction there requires analyticity and Proposition 2.5.2 uses that the values ω_{\pm} defined in (2.5.9) are nonzero, which might not be true for large a . However, it is very possible that the construction of the scattering resolvent of [128] can be used instead. The methods of [128] are stable under rather general perturbations, see [128, §2.7], and apply in particular to Kerr–de Sitter black holes with a satisfying [128, (6.12)].

A more serious problem is the fact that Theorem 2.1 is a quantization condition, and thus is expected to hold only when the geodesic flow is completely integrable, at least on the trapped set. For large a , the separation of variables of §2.2.2 is still valid, and it is conceivable that the global structure of the angular integrable system in §2.4.2 and of the radial barrier-top Schrödinger operator in §2.5.1 would be preserved, yielding Theorem 2.1 in this case. Even then, the proof of Theorem 2.2 no longer applies as it relies on having gaps between the imaginary parts of resonances, which might disappear for large a .

However, a generic smooth perturbation of the metric supported near the trapped set will destroy complete integrability and thus any hope of obtaining Theorem 2.1. One way of dealing with this is to impose the condition that the geodesic flow is completely integrable on the trapped set. In principle, the global analysis of [130] together with the methods for handling $O(\hbar)$ nonselfadjoint perturbations developed in §2.4 and Appendix 2.A should provide the quantization condition in the direction of the trapped set, while the barrier-top resonance analysis of §2.5.3 should handle the transversal directions. However, without separation of variables one might need to merge these methods and construct a normal form at the trapped set which is not presented here.

Another possibility is to try to establish Theorem 2.2 without a quantization condition, perhaps under the (stable under perturbations) assumption that the trapped set is normally hyperbolic as in [132]. However, this will require to rethink the contour deformation argument, as it is not clear which contour to deform to when there is no stratification of resonances by depth, corresponding to the parameter m in Theorem 2.1.

2.2 Proofs of Theorems 2.1 and 2.2

2.2.1 Properties of the metric

First of all, we define Kerr–de Sitter metric and briefly review how solutions of the wave equation are related to the scattering resolvent; see also §1.2 and [128, §6]. The metric is given by

$$g = -\rho^2 \left(\frac{dr^2}{\Delta_r} + \frac{d\theta^2}{\Delta_\theta} \right) - \frac{\Delta_\theta \sin^2 \theta}{(1 + \alpha)^2 \rho^2} (a dt - (r^2 + a^2) d\varphi)^2 \\ + \frac{\Delta_r}{(1 + \alpha)^2 \rho^2} (dt - a \sin^2 \theta d\varphi)^2.$$

Here $\theta \in [0, \pi]$ and $\varphi \in \mathbb{R}/2\pi\mathbb{Z}$ are the spherical coordinates on \mathbb{S}^2 and r, t take values in \mathbb{R} ; M is the mass of the black hole, Λ is the cosmological constant, and a is the angular momentum;

$$\begin{aligned}\Delta_r &= (r^2 + a^2) \left(1 - \frac{\Lambda r^2}{3}\right) - 2Mr, \quad \Delta_\theta = 1 + \alpha \cos^2 \theta, \\ \rho^2 &= r^2 + a^2 \cos^2 \theta, \quad \alpha = \frac{\Lambda a^2}{3}.\end{aligned}$$

The metric in the (t, r, θ, φ) coordinates is defined for $\Delta_r > 0$; we assume that this happens on an open interval $r \in (r_-, r_+)$, where r_\pm are two of the roots of the fourth order polynomial equation $\Delta_r(r) = 0$. The metric becomes singular at $r = r_\pm$; however, this apparent singularity goes away if we consider the following version of the Kerr-star coordinates (see [30, §5.1] and [122]):

$$t^* = t - F_t(r), \quad \varphi^* = \varphi - F_\varphi(r), \quad (2.2.1)$$

with the functions F_t, F_φ blowing up like $c_\pm \log |r - r_\pm|$ as r approaches r_\pm . One can choose F_t, F_φ so that the metric continues smoothly across the surfaces $\{r = r_\pm\}$, called event horizons, to

$$\tilde{X}_{-\delta} = \mathbb{R}_t \times X_{-\delta}, \quad X_{-\delta} = (r_- - \delta, r_+ + \delta) \times \mathbb{S}^2,$$

with $\delta > 0$ is a small constant. Moreover, the surfaces $\{t^* = \text{const}\}$ are spacelike, while the surfaces $\{r = \text{const}\}$ are timelike for $r \in (r_-, r_+)$, spacelike for $r \notin [r_-, r_+]$, and null for $r \in \{r_-, r_+\}$. See 1.2, [46, §1.1], or [128, §6.4] for more information on how to construct F_t, F_φ with these properties.

Let \square_g be the d'Alembert–Beltrami operator of the Kerr–de Sitter metric. Take $f \in H^{s-1}(\tilde{X}_{-\delta})$ for some $s \geq 1$, and furthermore assume that f is supported in $\{0 \leq t^* \leq 1\}$. Then, since the boundary of $\tilde{X}_{-\delta}$ is spacelike and every positive time oriented vector at $\partial\tilde{X}_{-\delta}$ points outside of $\tilde{X}_{-\delta}$, by the theory of hyperbolic equations (see for example [30, Proposition 3.1.1] or [123, Sections 2.8 and 7.7]) there exists unique solution $u \in H_{\text{loc}}^s(\tilde{X}_{-\delta})$ to the problem

$$\square_g u = f, \quad \text{supp } u \subset \{t^* \geq 0\}. \quad (2.2.2)$$

We will henceforth consider the problem (2.2.2); the Cauchy problem (2.1.5) can be reduced to (2.2.2) as follows. Assume that u solves (2.1.5) with some $f_0 \in H^s(X_{-\delta})$, $f_1 \in H^{s-1}(X_{-\delta})$. Take a function $\chi \in C^\infty(\mathbb{R})$ such that $\text{supp } \chi \subset \{t^* > 0\}$ and $\text{supp}(1 - \chi) \subset \{t^* < 1\}$; then $\chi(t^*)u$ solves (2.2.2) with $f = [\square_g, \chi]u$ supported in $\{0 \leq t^* \leq 1\}$ and the H^{s-1} norm of f is controlled by $\|f_0\|_{H^s} + \|f_1\|_{H^{s-1}}$.

Since the metric is stationary, there exists a constant C_e such that every solution u to (2.2.2) grows slower than $e^{(C_e-1)t^*}$; see Proposition 1.2.1. Therefore, the Fourier–Laplace transform

$$\hat{u}(\omega) = \int e^{i\omega t^*} u(t^*) dt^*$$

is well-defined and holomorphic in $\{\text{Im } \omega \geq C_e\}$. Here both $u(t^*)$ and $u(\omega)$ are functions on $X_{-\delta}$. Moreover, if $\hat{f}(\omega)$ is the Fourier–Laplace transform of f , then

$$P_g(\omega)\hat{u}(\omega) = \rho^2 \hat{f}(\omega), \quad \text{Im } \omega \geq C_e, \quad (2.2.3)$$

where $P_g(\omega)$ is the stationary d’Alembert–Beltrami operator, obtained by replacing D_{t^*} with $-\omega$ in $\rho^2 \square_g$. (The ρ^2 factor will prove useful in the next subsection.) Finally, since f is supported in $\{0 \leq t^* \leq 1\}$, the function $\hat{f}(\omega)$ is holomorphic in the entire \mathbb{C} , and

$$\|\langle \omega \rangle^{s-1} \hat{f}(\omega)\|_{H_{(\omega)^{-1}}^{s-1}(X_{-\delta})} \leq C \|f\|_{H^{s-1}(\tilde{X}_{-\delta})} \quad (2.2.4)$$

for $\text{Im } \omega$ bounded by a fixed constant. Here H_h^{s-1} , $h > 0$, is the semiclassical Sobolev space, consisting of the same functions as H^{s-1} , but with norm $\|\langle hD \rangle^{s-1} f\|_{L^2}$ instead of $\|\langle D \rangle^{s-1} f\|_{L^2}$.

If $P_g(\omega)$ was, say, an elliptic operator, then the equation (2.2.3) would have many solutions; however, because of the degeneracies occurring at the event horizons, the requirement that $\hat{u} \in H^s$ acts as a boundary condition. This situation was examined in detail in [128]; the following proposition follows from [128, Theorem 1.2 and Lemma 3.1] (see Proposition 1.2.2 for the cutoff version):

Proposition 2.2.1. *Fix $\nu_0 > 0$. Then for s large enough depending on ν_0 , there exists a family of operators (called the scattering resolvent)*

$$R(\omega) : H^{s-1}(X_{-\delta}) \rightarrow H^s(X_{-\delta}), \quad \text{Im } \omega \geq -\nu_0,$$

meromorphic with poles of finite rank and such that for u solving (2.2.2), we have

$$\hat{u}(\omega) = R(\omega)\hat{f}(\omega), \quad \text{Im } \omega \geq C_e. \quad (2.2.5)$$

Note that even though we originally defined the left-hand side of (2.2.5) for $\text{Im } \omega \geq C_e$, the right-hand side of this equation makes sense in a wider region $\text{Im } \omega \geq -\nu_0$, and in fact in the entire complex plane if f is smooth. The idea now is to use Fourier inversion formula

$$u(t^*) = \frac{1}{2\pi} \int_{\text{Im } \omega = C_e} e^{-i\omega t^*} R(\omega)\hat{f}(\omega) d\omega \quad (2.2.6)$$

and deform the contour of integration to $\{\text{Im } \omega = -\nu_0\}$ to get exponential decay via the $e^{-i\omega t^*}$ factor. We pick up residues from the poles of $R(\omega)$ when deforming the contour; therefore, *one defines quasi-normal modes as the poles of $R(\omega)$.*

Our ability to deform the contour and estimate the resulting integral depends on having polynomial resolvent estimates. To formulate these, let us give the technical

Definition 2.2.2. *Let $h > 0$ be a parameter and $\mathcal{R}(\omega; h) : \mathcal{H}_1 \rightarrow \mathcal{H}_2$, $\omega \in \mathcal{U}(h) \subset \mathbb{C}$, be a meromorphic family of operators, with \mathcal{H}_j Hilbert spaces. Let also $\Omega(h) \subset \mathcal{U}(h)$ be open and $\mathcal{Z}(h) \subset \mathbb{C}$ be a finite subset; we allow elements of $\mathcal{Z}(h)$ to have multiplicities. We say that the poles of \mathcal{R} in $\Omega(h)$ are simple with a polynomial resolvent estimate and given modulo $O(h^\infty)$ by $\mathcal{Z}(h)$, if for h small enough, there exist maps \mathcal{Q} and Π from $\mathcal{Z}(h)$ to \mathbb{C} and the algebra of bounded operators $\mathcal{H}_1 \rightarrow \mathcal{H}_2$, respectively, such that:*

- for each $\widehat{\omega}' \in \mathcal{Z}(h)$, $\widehat{\omega} = \mathcal{Q}(\widehat{\omega}')$ is a pole of \mathcal{R} , $|\widehat{\omega} - \widehat{\omega}'| = O(h^\infty)$, and $\Pi(\widehat{\omega}')$ is a rank one operator;
- there exists a constant N such that $\|\Pi(\widehat{\omega}')\|_{\mathcal{H}_1 \rightarrow \mathcal{H}_2} = O(h^{-N})$ for each $\widehat{\omega}' \in \mathcal{Z}(h)$ and, moreover,

$$\mathcal{R}(\omega; h) = \sum_{\widehat{\omega}' \in \mathcal{Z}(h)} \frac{\Pi(\widehat{\omega}')}{\omega - \mathcal{Q}(\widehat{\omega}')} + O_{\mathcal{H}_1 \rightarrow \mathcal{H}_2}(h^{-N}), \quad \omega \in \Omega(h).$$

In particular, every pole of \mathcal{R} in $\Omega(h)$ lies in the image of \mathcal{Q} .

The quantization condition and resolvent estimate that we need to prove Theorems 2.1 and 2.2 are contained in

Proposition 2.2.3. *Fix $\nu_0 > 0$ and let $h > 0$ be a parameter. Then for a small enough (independently of ν_0), the poles of $R(\omega)$ in the region*

$$|\operatorname{Im} \omega| < \nu_0, \quad h^{-1} < |\operatorname{Re} \omega| < 2h^{-1}, \quad (2.2.7)$$

are simple with a polynomial resolvent estimate and given modulo $O(h^\infty)$ by

$$\begin{aligned} \omega &= h^{-1} \mathcal{F}^\omega(m, hl, hk; h), \quad m, l, k \in \mathbb{Z}, \\ 0 \leq m \leq C_m, \quad C_l^{-1} \leq hl \leq C_l, \quad |k| \leq l. \end{aligned} \quad (2.2.8)$$

Here C_m and C_l are some constants and $\mathcal{F}^\omega(m, \tilde{l}, \tilde{k}; h)$ is a classical symbol:

$$\mathcal{F}^\omega(m, \tilde{l}, \tilde{k}; h) \sim \sum_{j \geq 0} h^j \mathcal{F}_j^\omega(m, \tilde{l}, \tilde{k}).$$

The principal symbol \mathcal{F}_0^ω is real-valued and independent of m ; moreover,

$$\begin{aligned} \mathcal{F}^\omega(m, \tilde{l}, \tilde{k}; h) &= \frac{\sqrt{1 - 9\Lambda M^2}}{3\sqrt{3}M} (\tilde{l} + h/2 - ih(m + 1/2)) + O(h^2) \text{ for } a = 0, \\ (\partial_{\tilde{k}} \mathcal{F}_0^\omega)(m, \pm \tilde{k}, \tilde{k}) &= \frac{(2 + 9\Lambda M^2)a}{27M^2} + O(a^2). \end{aligned}$$

Finally, if we consider $R(\omega)$ as a family of operators between the semiclassical Sobolev spaces $H_h^{s-1} \rightarrow H_h^s$, then the constant N in Definition 2.2.2 is independent of s .

Theorem 2.1 follows from the here almost immediately. Indeed, since $R(\omega)$ is independent of h , each \mathcal{F}_j^ω is homogeneous in (\tilde{l}, \tilde{k}) variables of degree $1 - j$; we can then extend this function homogeneously to the cone $|\tilde{k}| \leq \tilde{l}$ and define the (non-semiclassical) symbol

$$\mathcal{F}(m, l, k) \sim \sum_{j \geq 0} \mathcal{F}_j^\omega(m, l, k).$$

Note that $\mathcal{F}(m, l, k) = h^{-1}\mathcal{F}^\omega(m, hl, hk; h) + O(h^\infty)$ whenever $C_l^{-1} \leq hl \leq C_l$. We can then cover the region (2.1.1) for large C_ω with the regions (2.2.7) for a sequence of small values of h to see that QNMs in (2.1.1) are given by (2.1.2) modulo $O(|\omega|^{-\infty})$.

Now, we prove Theorem 2.2. Let u be a solution to (2.2.2), with $f \in H^{s-1}$ and s large enough. We claim that one can deform the contour in (2.2.6) to get

$$u(t^*) = i \sum_{\text{Im } \hat{\omega} > -\nu_0} \text{Res}_{\omega=\hat{\omega}} [e^{-i\omega t^*} R(\omega) \hat{f}(\omega)] + \frac{1}{2\pi} \int_{\text{Im } \omega = -\nu_0} e^{-i\omega t^*} R(\omega) \hat{f}(\omega) d\omega. \quad (2.2.9)$$

The series in (2.2.9) is over QNMs $\hat{\omega}$; all but a finite number of them in the region $\{\text{Im } \omega > -\nu_0\}$ are equal to $\mathcal{Q}(\hat{\omega}')$ for some $\hat{\omega}'$ given by (2.1.2) and the residue in this case is $e^{-i\hat{\omega} t^*} \Pi(\hat{\omega}') \hat{f}(\hat{\omega}')$. Here \mathcal{Q} and Π are taken from Definition 2.2.2. Now, by (2.2.4), we have

$$\begin{aligned} \|\Pi(\hat{\omega}') \hat{f}(\hat{\omega}')\|_{H^1} &\leq C \langle \hat{\omega} \rangle^{N-s} \|f\|_{H^{s-1}}; \\ \|R(\omega) \hat{f}(\omega)\|_{H^1} &\leq C \langle \omega \rangle^{N-s} \|f\|_{H^{s-1}}, \quad \text{Im } \omega = -\nu_0, \end{aligned}$$

for some constant N independent of s ; therefore, for s large enough, the series in (2.2.9) converges in H^1 and the H^1 norm of the integral in (2.2.9) can be estimated by $Ce^{-\nu_0 t^*} \|f\|_{H^{s-1}}$, thus proving Theorem 2.2.

To prove (2.2.9), take small $h > 0$. There are $O(h^{-2})$ QNMs in the region (2.2.7); therefore, by pigeonhole principle we can find $\omega_0(h) \in [h^{-1}, 2h^{-1}]$ such that there are no QNMs h^2 -close to the segments

$$\gamma_\pm(h) = \{\text{Re } \omega = \pm\omega_0(h), \quad -\nu_0 \leq \text{Im } \omega \leq C_e\}.$$

Then $\|R(\omega) \hat{f}(\omega)\|_{H^1} = O(h^{s-N-4})$ on $\gamma_\pm(h)$; we can now apply the residue theorem to the rectangle formed from $\gamma_\pm(h)$ and segments of the lines $\{\text{Im } \omega = C_e\}, \{\text{Im } \omega = -\nu_0\}$, and then let $h \rightarrow 0$.

2.2.2 Separation of variables

First of all, using [128, (A.2), (A.3)], we reduce Proposition 2.2.3 to the following³

Proposition 2.2.4. *Take $\delta > 0$ and put*

$$K_\delta = (r_- + \delta, r_+ - \delta) \times \mathbb{S}^2, \quad R_g(\omega) = 1_{K_\delta} R(\omega) 1_{K_\delta} : L^2(K_\delta) \rightarrow H^2(K_\delta).$$

Then for a small enough⁴ and fixed ν_0 , the poles of $R_g(\omega)$ in the region (2.2.7) are simple with a polynomial resolvent estimate $L^2 \rightarrow L^2$ and given modulo $O(h^\infty)$ by (2.2.8).

³One could also try to apply the results of [38] here, but we use the slightly simpler construction of [128, Appendix], exploiting the fact that we have information on the exact cutoff resolvent.

⁴The smallness of a is implied in all following statements.

Furthermore, by [128, Proposition A.1] the family of operators $R_g(\omega)$ coincides with the one constructed in Theorem 1.2, if the functions F_t, F_φ in (2.2.1) are chosen so that $(t, \varphi) = (t^*, \varphi^*)$ in $\mathbb{R}_t \times K_\delta$. We now review how the construction of $R_g(\omega)$ in Chapter 1 works and reduce Proposition 2.2.4 to two separate spectral problems in the radial and the angular variables. For the convenience of reader, we include the simpler separation of variables procedure for the case $a = 0$ at the end of this section.

First of all, the operator $P_g(\omega)$ is invariant under the rotation $\varphi \mapsto \varphi + s$; therefore, the spaces $\mathcal{D}'_k = \text{Ker}(D_\varphi - k)$ of functions of angular momentum $k \in \mathbb{Z}$ are invariant under both $P_g(\omega)$ and $R_g(\omega)$. In Chapter 1, we construct $R_g(\omega)$ by piecing together the restrictions $R_g(\omega, k) = R_g(\omega)|_{\mathcal{D}'_k}$ for all k . Then, Proposition 2.2.4 follows from

Proposition 2.2.5. *Under the assumptions of Proposition 2.2.4, there exists a constant C_k such that for each $k \in \mathbb{Z}$,*

- (1) *if $h|k| > C_k$, then $R_g(\omega, k)$ has no poles in the region (2.2.7) and its $L^2 \rightarrow L^2$ norm is $O(|k|^{-2})$; (This is a reformulation of Proposition 1.4.3.)*
- (2) *if $h|k| \leq C_k$, then the poles of $R_g(\omega, k)$ in the region (2.2.7) are simple with a polynomial resolvent estimate $L^2 \rightarrow L^2$ and given modulo $O(h^\infty)$ by (2.2.8), with this particular value of k .*

Now, we recall from §1.2 that the restriction of $P_g(\omega)$ to \mathcal{D}'_k has the form⁵ $P_r(\omega, k) + P_\theta(\omega)|_{\mathcal{D}'_k}$, where

$$\begin{aligned} P_r(\omega, k) &= D_r(\Delta_r D_r) - \frac{(1+\alpha)^2}{\Delta_r} ((r^2 + a^2)\omega - ak)^2, \\ P_\theta(\omega) &= \frac{1}{\sin \theta} D_\theta(\Delta_\theta \sin \theta D_\theta) + \frac{(1+\alpha)^2}{\Delta_\theta \sin^2 \theta} (a\omega \sin^2 \theta - D_\varphi)^2 \end{aligned} \tag{2.2.10}$$

are differential operators in r and (θ, φ) , respectively. Then $R_g(\omega, k)$ is constructed in the proof of Theorem 1.1 using a certain contour integral (1.3.1) and the radial and angular resolvents

$$\begin{aligned} R_r(\omega, \lambda, k) &: L^2_{\text{comp}}(r_-, r_+) \rightarrow H^2_{\text{loc}}(r_-, r_+), \\ R_\theta(\omega, \lambda) &: L^2(\mathbb{S}^2) \rightarrow H^2(\mathbb{S}^2), \quad \lambda \in \mathbb{C}; \end{aligned}$$

R_r is a certain right inverse to $P_r(\omega, k) + \lambda$, while R_θ is the inverse to $P_\theta(\omega) - \lambda$; we write $R_\theta(\omega, \lambda, k) = R_\theta(\omega, \lambda)|_{\mathcal{D}'_k}$. Recall that both R_r and R_θ are meromorphic families of operators, as defined in Definition 1.3.2; in particular, for a fixed value of ω , these families are meromorphic in λ with poles of finite rank. By definition of $R_g(\omega, k)$, a number $\omega \in \mathbb{C}$ is a pole of this operator if and only if there exists $\lambda \in \mathbb{C}$ such that (ω, λ, k) is a pole of both R_r and R_θ .

⁵The operator $P_g(\omega)$ of Chapter 1 differs from the operator used in this chapter by the conjugation done in [128, Appendix]; however, the two coincide in K_δ .

Now, for small $h > 0$ we put

$$\tilde{\omega} = h \operatorname{Re} \omega, \quad \tilde{\nu} = \operatorname{Im} \omega, \quad \tilde{\lambda} = h^2 \operatorname{Re} \lambda, \quad \tilde{\mu} = h \operatorname{Im} \lambda, \quad \tilde{k} = hk; \quad (2.2.11)$$

the assumptions of Proposition 2.2.5(2) imply that $1 \leq \tilde{\omega} \leq 2$, $|\tilde{\nu}| \leq \nu_0$, and $|\tilde{k}| \leq C_k$. Moreover, Proposition 1.4.4 suggests that under these assumptions, all values of λ for which (ω, λ, k) is a pole of both R_r and R_θ have to satisfy $|\tilde{\lambda}|, |\tilde{\mu}| \leq C_\lambda$, for some constant C_λ .

We are now ready to state the quantization conditions and resolvent estimates for R_r and R_θ ; the former is proved in §2.5 and the latter, in §2.4.

Proposition 2.2.6 (Radial lemma). *Let C_λ be a fixed constant and put $K_r = (r_- + \delta, r_+ - \delta)$. Then the poles of $1_{K_r} R_r(\omega, \lambda, k) 1_{K_r}$ as a function of λ , in the region*

$$1 < \tilde{\omega} < 2, \quad |\tilde{\nu}| < \nu_0, \quad |\tilde{k}| < C_k, \quad |\tilde{\lambda}|, |\tilde{\mu}| < C_\lambda, \quad (2.2.12)$$

are simple with polynomial resolvent estimate $L^2 \rightarrow L^2$ (in the sense of Definition 2.2.2) and given modulo $O(h^\infty)$ by

$$\tilde{\lambda} + ih\tilde{\mu} = \mathcal{F}^r(m, \tilde{\omega}, \tilde{\nu}, \tilde{k}; h), \quad m \in \mathbb{Z}, \quad 0 \leq m \leq C_m, \quad (2.2.13)$$

for some constant C_m . The principal part \mathcal{F}_0^r of the classical symbol \mathcal{F}^r is real-valued, independent of m and $\tilde{\nu}$, and

$$\begin{aligned} \mathcal{F}^r &= \left[ih(m + 1/2) + \frac{3\sqrt{3}M}{\sqrt{1 - 9\Lambda M^2}}(\tilde{\omega} + ih\tilde{\nu}) \right]^2 + O(h^2) \text{ for } a = 0, \\ \mathcal{F}_0^r(\tilde{\omega}, \tilde{k}) &= \frac{27M^2}{1 - 9\Lambda M^2} \tilde{\omega}^2 - \frac{6a\tilde{k}\tilde{\omega}}{1 - 9\Lambda M^2} + O(a^2). \end{aligned}$$

In particular, for ω, k satisfying (2.2.12), every pole λ satisfies $\tilde{\lambda} > \varepsilon$ for some constant $\varepsilon > 0$.

Proposition 2.2.7 (Angular lemma). *Let C_θ be a fixed constant. Then the poles of $R_\theta(\omega, \lambda, k)$ as a function of λ in the region*

$$1 < \tilde{\omega} < 2, \quad |\tilde{\nu}| < \nu_0, \quad |\tilde{k}| < C_k, \quad C_\theta^{-1} < \tilde{\lambda} < C_\theta, \quad |\tilde{\mu}| < C_\theta, \quad (2.2.14)$$

are simple with polynomial resolvent estimate $L^2 \rightarrow L^2$ and given modulo $O(h^\infty)$ by

$$\tilde{\lambda} + ih\tilde{\mu} = \mathcal{F}^\theta(hl, \tilde{\omega}, \tilde{\nu}, \tilde{k}; h), \quad l \in \mathbb{Z}, \quad \max(|\tilde{k}|, C_l^{-1}) \leq hl \leq C_l, \quad (2.2.15)$$

for some constant C_l . The principal part \mathcal{F}_0^θ of the classical symbol \mathcal{F}^θ is real-valued, independent of $\tilde{\nu}$, and

$$\mathcal{F}^\theta = \tilde{l}(\tilde{l} + h) + O(h^\infty) \text{ for } a = 0.$$

Moreover, $\mathcal{F}_0^\theta(\pm\tilde{k}, \tilde{\omega}, \tilde{k}) = (1 + \alpha)^2(\tilde{k} - a\tilde{\omega})^2$, $\partial_{\tilde{l}} \mathcal{F}_0^\theta(\pm\tilde{k}, \tilde{\omega}, \tilde{k}) = \pm 2\tilde{k} + O(a^2)$, and consequently, $\partial_{\tilde{k}} \mathcal{F}_0^\theta(\pm\tilde{k}, \tilde{\omega}, \tilde{k}) = -2a\tilde{\omega} + O(a^2)$.

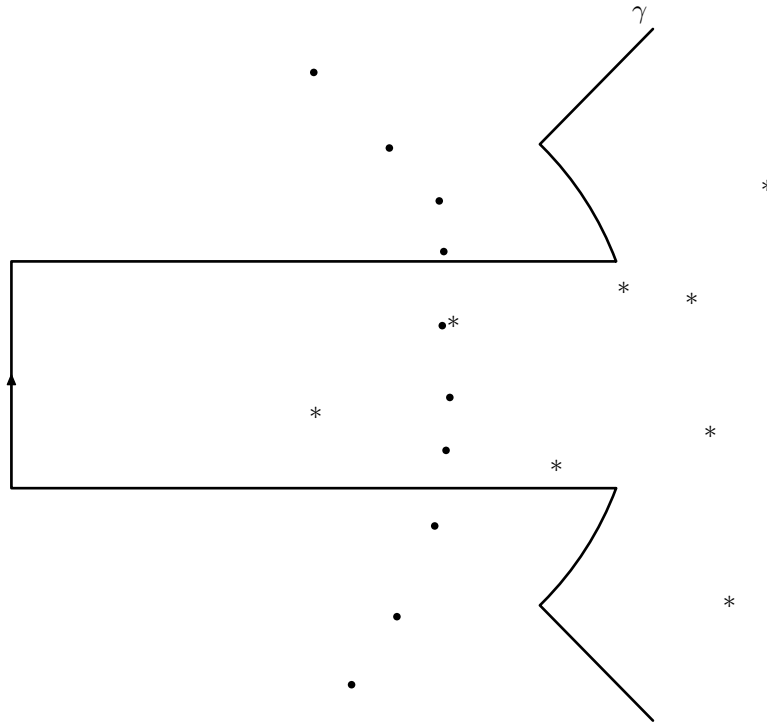

Figure 2.1: The contour γ and interaction between radial poles (denoted by dots) and angular poles (denoted by asterisks).

Combining Propositions 2.2.6 and 2.2.7 with the results of Chapter 1, we get

Proof of Proposition 2.2.5. We let $\mathcal{F}^\omega(m, \tilde{l}, \tilde{k}; h)$ be the solution $\tilde{\omega} + ih\tilde{\nu}$ to the equation

$$\mathcal{F}^r(m, \tilde{\omega}, \tilde{\nu}, \tilde{k}; h) = \mathcal{F}^\theta(\tilde{l}, \tilde{\omega}, \tilde{\nu}, \tilde{k}; h). \quad (2.2.16)$$

We can see that this equation has unique solution by writing $\mathcal{F}^r - \mathcal{F}^\theta = \mathcal{F}' + ih\mathcal{F}''$ and examining the principal parts of the real-valued symbols $\mathcal{F}', \mathcal{F}''$ for $a = 0$.

The idea now is to construct an admissible contour in the sense of Definition 1.3.5; e.g. a contour that separates the sets of poles (in the variable λ) of R_r and R_θ from each other; then (1.3.1) provides a formula for $R_g(\omega, k)$, which can be used to get a resolvent estimate. We will use the method of proof of Proposition 1.4.4. Take the contour γ introduced there, for $l_2 = C_\lambda h^{-1}$, $l_1 = L = C_\lambda h^{-2}$, and C_λ some large constant. Then we know that all angular poles are to the right of γ (in Γ_2). Moreover, the only radial poles to the right of γ lie in the domain $\{|\operatorname{Im} \lambda| \leq l_2, |\lambda| \leq L\}$ and they are contained in the set $\{\lambda_0^r, \dots, \lambda_{C_m}^r\}$ for some constant C_m , where $\lambda_m^r(\omega, k)$ is the radial pole corresponding to $h^{-2}\mathcal{F}^r(m, \tilde{\omega}, \tilde{\nu}, \tilde{k}; h)$. In particular, those radial poles are contained in

$$U_\lambda = \{C_\theta^{-1} < \tilde{\lambda} < C_\theta, |\tilde{\mu}| \leq C_\theta\},$$

for some constant C_θ .

Assume that ω is not a pole of $R_g(\omega, k)$; then we can consider the admissible contour composed of γ and the circles γ_m , $0 \leq m \leq C_m$, enclosing $\lambda_m^r(\omega, k)$, but none of the other poles of R_r or R_θ . Using the meromorphic decomposition of R_r at λ_m^r and letting its principal part be $\Pi_m^r/(\lambda - \lambda_m^r)$, we get

$$R_g(\omega, k) = \sum_m \Pi_m^r(\omega, k) \otimes R_\theta(\omega, \lambda_m^r(\omega, k), k) + \frac{1}{2\pi i} \int_\gamma R_r(\omega, \lambda, k) \otimes R_\theta(\omega, \lambda, k) d\lambda. \quad (2.2.17)$$

Here we only include the poles λ_m^r lying to the right of γ ; one might need to change l_1 in the definition of γ a little bit in case some λ_m^r comes close to γ . The integral in (2.2.17) is holomorphic and bounded polynomially in h , by the bounds for R_r given by Proposition 2.2.6, together with the estimates in the proof of Proposition 1.4.4.

Now, the poles of R_θ in U_λ are given by (2.2.15); let $\lambda_l^\theta(\omega, k)$ be the pole corresponding to $h^{-2}\mathcal{F}^\theta(hl, \tilde{\omega}, \tilde{\nu}, \tilde{k}; h)$ and $\Pi_l^\theta/(\lambda - \lambda_l^\theta)$ be the principal part of the corresponding meromorphic decomposition. Then the resolvent estimates on R_θ given by Proposition 2.2.7 together with (2.2.17) imply

$$R_g(\omega, k) = \text{Hol}(\omega) + \sum_{m,l} \frac{\Pi_m^r(\omega, k) \otimes \Pi_l^\theta(\omega, k)}{\lambda_m^r(\omega, k) - \lambda_l^\theta(\omega, k)}. \quad (2.2.18)$$

Here $\text{Hol}(\omega)$ is a family of operators holomorphic in ω and bounded polynomially in h . Moreover,

$$\lambda_m^r(\omega, k) - \lambda_l^\theta(\omega, k) = h^{-2}(\mathcal{F}^r(m, \tilde{\omega}, \tilde{\nu}, \tilde{k}; h) - \mathcal{F}^\theta(hl, \tilde{\omega}, \tilde{\nu}, \tilde{k}; h)) + O(h^\infty); \quad (2.2.19)$$

therefore, the equation $\lambda_m^r(\omega, k) - \lambda_l^\theta(\omega, k) = 0$ is an $O(h^\infty)$ perturbation of (2.2.16) and it has a unique solution $\omega_{m,l}(k)$, which is $O(h^\infty)$ close to $h^{-1}\mathcal{F}^\omega(m, hl, \tilde{k}; h)$. Finally, in the region (2.2.7) we can write by (2.2.18)

$$R_g(\omega, k) = \text{Hol}(\omega) + \sum_{m,l} \frac{\Pi_{m,l}(k)}{\omega - \omega_{m,l}(k)},$$

with $\text{Hol}(\omega)$ as above and $\Pi_{m,l}(k)$ being the product of a coefficient polynomially bounded in h with $(\Pi_m^r \otimes \Pi_l^\theta)(\omega_{m,l}(k), k)$; this finishes the proof. \square

Finally, let us present the simplified separation of variables for the case $a = 0$, namely the Schwarzschild–de Sitter metric:

$$g = \frac{\Delta_r}{r^2} dt^2 - \frac{r^2}{\Delta_r} dr^2 - r^2(d\theta^2 + \sin^2 \theta d\varphi^2),$$

$$\Delta_r = r^2 \left(1 - \frac{\Lambda r^2}{3} \right) - 2Mr.$$

Note that $d\theta^2 + \sin^2 \theta d\varphi^2$ is just the round metric on the unit sphere. The metric decouples without the need to take Fourier series in φ ; the stationary d'Alembert–Beltrami operator has the form $P_g(\omega) = P_r(\omega) + P_\theta$, where

$$P_r(\omega) = D_r(\Delta_r D_r) - \frac{r^4}{\Delta_r} \omega^2,$$

$$P_\theta = \frac{1}{\sin \theta} D_\theta(\sin \theta D_\theta) + \frac{D_\varphi^2}{\sin^2 \theta}.$$

Here P_θ is the Laplace–Beltrami operator on the round sphere; it is self-adjoint (thus no need for the contour integral construction of §1.3) and is known to have eigenvalues $l(l+1)$, where $l \geq 0$. Each such eigenvalue has multiplicity $2l+1$, corresponding to the values $-l, \dots, l$ of the φ -angular momentum k . The angular Lemma 2.2.7 follows immediately. (We nevertheless give a more microlocal explanation in this case at the end of §2.4.1.) One can now decompose L^2 into an orthogonal sum of the eigenspaces of P_θ ; on the space V_λ corresponding to the eigenvalue $\lambda = l(l+1)$, we have

$$P_g(\omega)|_{V_\lambda} = P_r(\omega) + \lambda.$$

Therefore, the only problem is to show the radial Lemma 2.2.6 in this case, which is in fact no simpler than the general case. (Note that we take a different path here than [103] and [17], using only real microlocal analysis near the trapped set, which immediately gives polynomial resolvent bounds.)

2.3 Preliminaries

2.3.1 Pseudodifferential operators and microlocalization

First of all, we review the classes of semiclassical pseudodifferential operators on manifolds and introduce notation used for these classes; see [137, Sections 9.3 and 14.2] or [39] for more information.

For $k \in \mathbb{R}$, we consider the symbol class $S^k(\mathbb{R}^n)$ consisting of functions $a(x, \xi; h)$ smooth in $(x, \xi) \in \mathbb{R}^{2n}$ and satisfying the following growth conditions: for each compact set $K \subset \mathbb{R}^n$ and each pair of multiindices α, β , there exists a constant $C_{\alpha\beta K}$ such that

$$|\partial_x^\alpha \partial_\xi^\beta a(x, \xi; h)| \leq C_{\alpha\beta K} \langle \xi \rangle^{k-|\beta|}, \quad x \in K, \quad \xi \in \mathbb{R}^n, \quad h > 0.$$

If we treat \mathbb{R}^{2n} as the cotangent bundle to \mathbb{R}^n , then the class S^k is invariant under changes of variables; this makes it possible, given a manifold M , to define the class $S^k(M)$ of symbols depending on $(x, \xi) \in T^*M$.

If $k \in \mathbb{R}$ and $a_j(x, \xi) \in S^{k-j}(M)$, $j = 0, 1, \dots$, is a sequence of symbols, then there exists the asymptotic sum

$$a(x, \xi; h) \sim \sum_{j \geq 0} h^j a_j(x, \xi); \tag{2.3.1}$$

i.e., a symbol $a(x, \xi; h) \in S^k(M)$ such that for every $J = 0, 1, \dots$,

$$a(x, \xi; h) - \sum_{0 \leq j < J} h^j a_j(x, \xi) \in h^J S^{k-J}.$$

The asymptotic sum a is unique modulo the class $h^\infty S^{-\infty}$ of symbols all of whose derivatives decay faster than $h^N \langle \xi \rangle^{-N}$ for each N on any compact set in x . If a is given by an asymptotic sum of the form (2.3.1), then we call it a classical symbol and write $a \in S_{\text{cl}}^k(M)$. We call $a_0(x, \xi)$ the principal part of the symbol $a(x, \xi; h)$.

Let $\Psi^k(M)$ be the algebra of (properly supported) semiclassical pseudodifferential operators on M with symbols in $S^k(M)$. If $H_{h,\text{loc}}^m(M)$, $m \in \mathbb{R}$, consists of functions locally lying in the semiclassical Sobolev space, then every element of $\Psi^k(M)$ is continuous $H_{h,\text{loc}}^m(M) \rightarrow H_{h,\text{loc}}^{m-k}(M)$ with every operator seminorm being $O(1)$ as $h \rightarrow 0$. Let $\Psi_{\text{cl}}^k(M)$ be the algebra of operators with symbols in $S_{\text{cl}}^k(M)$ and $\Psi_{\text{cl}}(M)$ be the union of $\Psi_{\text{cl}}^k(M)$ for all k . Next, let the operator class $h^\infty \Psi^{-\infty}(M)$ correspond to the symbol class $h^\infty S^{-\infty}(M)$; it can be characterized as follows: $A \in h^\infty \Psi^{-\infty}(M)$ if and only if for each N , A is continuous $H_{h,\text{loc}}^{-N}(M) \rightarrow H_{h,\text{loc}}^N(M)$, with every operator seminorm being $O(h^N)$. The full symbol of an element of $\Psi^k(M)$ cannot be recovered as a function on T^*M ; however, if $A \in \Psi_{\text{cl}}^k(M)$, then the principal symbol of A is an invariantly defined function on the cotangent bundle. If M is an open subset of \mathbb{R}^n , then we can define the full symbol of a pseudodifferential operator modulo $h^\infty S^{-\infty}$; we will always use Weyl quantization.

We now introduce microlocalization; see also [137, §8.4] and [117, §3]. Define $U \subset T^*M$ to be conic at infinity, if there exists a conic set $V \subset T^*M$ such that the symmetric difference of U and V is bounded when restricted to every compact subset of M . For $a \in S^k(M)$ and $U \subset T^*M$ open and conic at infinity, we say that a is rapidly decaying on U , if for every $V \subset U$ closed in T^*M , conic at infinity, and with compact projection onto M , every derivative of a decays on V faster than $h^N \langle \xi \rangle^{-N}$ for every N . We say that $A \in \Psi^k(M)$ vanishes microlocally on U if its full symbol (in any coordinate system) is rapidly decaying on U . If $A, B \in \Psi^k(M)$, then we say that $A = B$ microlocally on U , if $A - B$ vanishes microlocally on U .

For $A \in \Psi^k(M)$, we define the semiclassical wavefront set $\text{WF}_h(A) \subset T^*M$ as follows: $(x, \xi) \notin \text{WF}_h(A)$ if and only if A vanishes microlocally on some neighborhood of (x, ξ) . The set $\text{WF}_h(A)$ is closed; however, it need not be conic at infinity. Next, we say that A is compactly microlocalized, if there exists a compact set $K \subset T^*M$ such that A vanishes microlocally on $T^*M \setminus K$. We denote by $\Psi^{\text{comp}}(M)$ the set of compactly microlocalized operators. Here are some properties of microlocalization:

- If A vanishes microlocally on U_1 and U_2 , then it vanishes microlocally on $U_1 \cup U_2$.
- The set of pseudodifferential operators vanishing microlocally on some open and conic at infinity $U \subset T^*M$ is a two-sided ideal; so is the set of operators with wavefront set contained in some closed $V \subset T^*M$. In particular, $\text{WF}_h(AB) \subset \text{WF}_h(A) \cap \text{WF}_h(B)$.

- A vanishes microlocally on the whole T^*M if and only if it lies in $h^\infty\Psi^{-\infty}$.
- If A vanishes microlocally on U , then $\text{WF}_h(A) \cap U = \emptyset$; the converse is true if U is bounded. However,⁶ A does not necessarily vanish microlocally on the complement of $\text{WF}_h(A)$; for example, the operator $A = e^{-1/h}$ lies in Ψ^0 and has an empty wavefront set, yet it does not lie in $h^\infty\Psi^{-\infty}$.
- The set Ψ^{comp} forms a two-sided ideal and it lies in Ψ^{-N} for every N .
- Each $A \in \Psi^{\text{comp}}$ vanishes microlocally on the complement of $\text{WF}_h(A)$.
- Let $A \in \Psi_{\text{cl}}^k(M)$ and let its symbol in some coordinate system have the form (2.3.1); introduce

$$V = \bigcup_{j \geq 0} \text{supp } a_j.$$

Then A vanishes microlocally on some open set U if and only if $U \cap V = \emptyset$; A is compactly microlocalized if V is bounded, and $\text{WF}_h(A)$ is the closure of V .

We now consider microlocally defined operators. Let $U \subset T^*M$ be open. A local pseudodifferential operator A on U is, by definition, a map

$$B \mapsto [A \cdot B] \in \Psi^{\text{comp}}(M)/h^\infty\Psi^{-\infty}(M), \quad B \in \Psi^{\text{comp}}(M), \quad \text{WF}_h(B) \subset U,$$

such that:

- $\text{WF}_h([A \cdot B]) \subset \text{WF}_h(B)$.
- If $B_1, B_2 \in \Psi^{\text{comp}}(M)$ and $\text{WF}_h(B_j) \subset U$, then $[A \cdot (B_1 + B_2)] = [A \cdot B_1] + [A \cdot B_2]$.
- If $C \in \Psi^k(M)$, then $[A \cdot B]C = [A \cdot (BC)]$.

We denote by $\Psi^{\text{loc}}(U)$ the set of all local operators on U . Note that a local operator is only defined modulo an $h^\infty\Psi^{-\infty}$ remainder. If $A \in \Psi^k(M)$, then the corresponding local operator \tilde{A} is given by $[\tilde{A} \cdot B] = AB \pmod{h^\infty\Psi^{-\infty}}$; we say that A represents \tilde{A} . For $M = \mathbb{R}^n$ and $U \subset T^*M$, there is a one-to-one correspondence between local operators and their full symbols modulo h^∞ ; the symbols of local operators are functions $a(x, \xi; h)$ smooth in $(x, \xi) \in U$ all of whose derivatives are uniformly bounded in h on compact subsets of U . In fact, for a symbol $a(x, \xi; h)$, the corresponding local operator is defined by $[A \cdot B] = (a \# b)^w(x, hD_x)$, where $b(x, \xi; h)$ is the full symbol of $B \in \Psi^{\text{comp}}$; since b is compactly supported inside U modulo $O(h^\infty)$ and a is defined on U , we can define the symbol product $a \# b$ uniquely modulo $O(h^\infty)$. In particular, a classical local operator $A \in \Psi_{\text{cl}}^{\text{loc}}(M)$ is uniquely determined by the terms of the decomposition (2.3.1) of its full symbol. Note

⁶This issue can be avoided if we consider $\text{WF}_h(A)$ as a subset of the fiber compactified cotangent bundle $\overline{T^*M}$, as in [128, §2.1]. Then an operator is compactly microlocalized if and only if its wavefront set does not intersect the fiber infinity.

that U is not required to be conic at infinity, and we do not impose any conditions on the growth of a as $\xi \rightarrow \infty$.

Local operators form a sheaf of algebras; that is, one can multiply local operators defined on the same set, restrict a local operator to a smaller set, and reconstruct a local operator from its restrictions to members of some finite open covering of U . This makes it possible to describe any local operator $A \in \Psi^{\text{loc}}(U)$ on a manifold using its full symbols in various coordinate charts. For $A \in \Psi^{\text{loc}}(U)$, one can define its wavefront set $\text{WF}_h(A)$ as follows: $(x_0, \xi_0) \notin \text{WF}_h(A)$ if and only if the full symbol of A is $O(h^\infty)$ in some neighborhood of (x_0, ξ_0) . If $A \in \Psi^k$ represents $\tilde{A} \in \Psi^{\text{loc}}$, then $\text{WF}_h(A) = \text{WF}_h(\tilde{A})$; in general, wavefront sets of local operators obey $\text{WF}_h(A + B) \subset \text{WF}_h(A) \cup \text{WF}_h(B)$ and $\text{WF}_h(AB) \subset \text{WF}_h(A) \cap \text{WF}_h(B)$.

Finally, we study microlocalization of arbitrary operators. Let M_1 and M_2 be two manifolds. An h -dependent family of (properly supported) operators $A(h) : C^\infty(M_1) \rightarrow \mathcal{D}'(M_2)$ is called tempered, or polynomially bounded, if for every compact $K_1 \subset M_1$, there exist N and C such that for any $u \in C_0^\infty(K_1)$, $\|A(h)u\|_{H_h^{-N}(M_2)} \leq Ch^{-N}\|u\|_{H_h^N}$. Note that the composition of a tempered operator with an element of Ψ^k is still tempered. We can also treat distributions on M_2 as operators from a singleton to M_2 .

For a tempered family $A(h)$, we define its wavefront set $\text{WF}_h(A) \subset T^*(M_1 \times M_2)$ as follows: $(x, \xi; y, \eta) \notin \text{WF}_h(A)$, if and only if there exist neighborhoods $U_1(x, \xi)$ and $U_2(y, \eta)$ such that for every $B_j \in \Psi^{\text{comp}}(M_j)$ with $\text{WF}_h(B_j) \subset U_j$, we have $B_2 A(h) B_1 \in h^\infty \Psi^{-\infty}$. We say that $A_1 = A_2$ microlocally in some open and bounded $U \subset T^*M$, if $\text{WF}_h(A_1 - A_2) \cap U = \emptyset$. Also, $A(h)$ is said to be compactly microlocalized, if there exist $C_j \in \Psi^{\text{comp}}(M_j)$ such that $A(h) - C_2 A(h) C_1 \in h^\infty \Psi^{-\infty}$. In this case, all operator norms $\|A(h)\|_{H_h^{N_1} \rightarrow H_h^{N_2}}$ are equivalent modulo $O(h^\infty)$; if any of these norms is $O(h^r)$ for some constant r , we write $\|A(h)\| = O(h^r)$. Here are some properties:

- If A is compactly microlocalized, then $\text{WF}_h(A)$ is compact. The converse, however, need not be true.
- If $A \in \Psi^k(M)$, then the two definitions of compact microlocalization of A (via its symbol and as a tempered family of operators) agree; the wavefront set of A as a tempered family of operators is just $\{(x, \xi; x, \xi) \mid (x, \xi) \in \text{WF}_h(A)\}$.
- If A_1, A_2 are two tempered operators and at least one of them is either compactly microlocalized or pseudodifferential, then the product $A_2 A_1$ is a tempered operator, and

$$\begin{aligned} \text{WF}_h(A_2 A_1) &\subset \text{WF}_h(A_1) \circ \text{WF}_h(A_2) \\ &= \{(x, \xi; z, \zeta) \mid \exists (y, \eta) : (x, \xi; y, \eta) \in \text{WF}_h(A_1), (y, \eta; z, \zeta) \in \text{WF}_h(A_2)\}. \end{aligned}$$

Moreover, if both A_1, A_2 are compactly microlocalized, so is $A_2 A_1$.

Let us quote the following microlocalization fact for oscillatory integrals, which is the starting point for the construction of semiclassical Fourier integral operators used in §2.3.3:

Proposition 2.3.1. *Assume that M is a manifold, $U \subset M \times \mathbb{R}^m$ is open, $\varphi(x, \theta)$ is a smooth real-valued function on U , with $x \in M$ and $\theta \in \mathbb{R}^m$, and $a(x, \theta) \in C_0^\infty(U)$. Then the family of distributions*

$$u(x) = \int_{\mathbb{R}^m} e^{i\varphi(x, \theta)/h} a(x, \theta) d\theta$$

is compactly microlocalized and

$$\text{WF}_h(u) \subset \{(x, \partial_x \varphi(x, \theta)) \mid (x, \theta) \in \text{supp } a, \partial_\theta \varphi(x, \theta) = 0\}.$$

2.3.2 Ellipticity and formal functional calculus

Assume that $U \subset T^*M$ is open and $A \in \Psi_{\text{cl}}^{\text{loc}}(U)$. We say that A is (semiclassically) elliptic on U if its principal symbol does not vanish on U . Under this condition, there exists unique operator $A^{-1} \in \Psi_{\text{cl}}^{\text{loc}}(U)$ such that $A^{-1}A, AA^{-1} = I$ as local operators. The next proposition provides the form of the symbol of A^{-1} ; it is based on the standard parametrix construction:

Proposition 2.3.2. *Fix a coordinate system on M . Assume that $A \in \Psi_{\text{cl}}^{\text{loc}}(U)$ is elliptic and has the full symbol $a \sim a_0 + ha_1 + h^2a_2 + \dots$. Then A^{-1} has the full symbol $b \sim b_0 + hb_1 + h^2b_2 + \dots$, where each b_j is a linear combination with constant coefficients of the terms of the form*

$$a_0^{-M-1} \prod_{m=1}^M \partial_x^{\alpha_m} \partial_\xi^{\beta_m} a_{l_m}. \quad (2.3.2)$$

Here the (multi)indices α_m, β_m, l_m satisfy the condition

$$\sum_{m=1}^M |\alpha_m| = \sum_{m=1}^M |\beta_m| = j - \sum_{m=1}^M l_m.$$

Furthermore, we can assume that $|\alpha_m| + |\beta_m| + l_m > 0$ for all m .

Proof. We call (2.3.2) an expression of type (M_α, M_β, L) , where M_α, M_β, L are the sums of $|\alpha_m|, |\beta_m|$, and l_m , respectively. If f is an expression of type (M_α, M_β, L) , then we can prove by induction that $\partial_x^\alpha \partial_\xi^\beta f$ is an expression of type $(M_\alpha + |\alpha|, M_\beta + |\beta|, L)$. Now, we write the equation $a\#b = 1$; the principal term gives $b_0 = a_0^{-1}$, and the next terms give that each b_j is the sum of expressions of type $(j - L, j - L, L)$, by induction and the formula for the symbol product $a\#b$. \square

Let $A \in \Psi_{\text{cl}}^k$; we say that it is elliptic on an open conic at infinity $U \subset T^*M$ in the class Ψ^k (or microlocally elliptic), if its principal symbol a_0 satisfies $|a_0(x, \xi)| \geq \langle \xi \rangle^k / C(K)$ for (x, ξ) in any given closed conic at infinity $K \subset U$ with compact projection onto M , and some constant $C(K)$ depending on K . In this case, the full symbol of A^{-1} satisfies the decay conditions of the class Ψ^{-k} in U . In particular, if $A \in \Psi_{\text{cl}}^k$ is elliptic in the class Ψ^k everywhere, then we can define $A^{-1} \in \Psi_{\text{cl}}^{-k}$ for h small enough.

We now construct functional calculus of local real principal pseudodifferential operators. For this, we use holomorphic functional calculus [45, §7.3]; another approach would be via almost analytic continuation [39, Chapter 8]. First, assume that $A \in \Psi_{\text{cl}}^{\text{comp}}(M)$ has compactly supported Schwartz kernel. In particular, the principal symbol a_0 of A is compactly supported; let $K \subset \mathbb{C}$ be the image of a_0 . Let $f(z)$ be holomorphic in a neighborhood Ω of K , and let $\gamma \subset \Omega$ be a contour such that K lies inside of γ . For each h , the operator A is bounded $L^2 \rightarrow L^2$; for h small enough, its spectrum lies inside of γ . Then we can define the operator $f(A)$ by the formula

$$f(A) = \frac{1}{2\pi i} \oint_{\gamma} f(z)(z - A)^{-1} dz.$$

For $z \in \gamma$, the operator $z - A$ is elliptic in the class Ψ^0 ; therefore, $(z - A)^{-1} \in \Psi_{\text{cl}}^0(M)$. It follows that $f(A) \in \Psi_{\text{cl}}^0(M)$. By Proposition 2.3.2, the full symbol of $f(A)$ (in any coordinate system) is the asymptotic sum

$$\sum_{j=0}^{\infty} h^j \sum_{M=0}^{2j} f^{(M)}(a_0(x, \xi)) b_{jM}(x, \xi). \quad (2.3.3)$$

Here $a \sim a_0 + ha_1 + \dots$ is the full symbol of A ; b_{jM} are the functions resulting from applying certain nonlinear differential operators to a_0, a_1, \dots .

Now, assume that $U \subset T^*M$ is open and $A \in \Psi_{\text{cl}}^{\text{loc}}(U)$ has real-valued principal symbol a_0 . Then the formula (2.3.3) can be used to define an operator $f[A] \in \Psi_{\text{cl}}^{\text{loc}}(U)$ for any $f \in C^\infty(\mathbb{R})$. Note that the principal symbol of $(z - A)^{-1}$ is $(z - a_0)^{-1}$; therefore, the principal symbol of $f[A]$ is $f \circ a_0$. The constructed operation possesses the following properties of functional calculus:

Proposition 2.3.3. *Assume that $U \subset T^*M$ is open, $A \in \Psi_{\text{cl}}^{\text{loc}}(U)$, and $f, g \in C^\infty(\mathbb{R})$. Then:*

1. $\text{WF}_h(f[A]) \subset a_0^{-1}(\text{supp } f)$, where a_0 is the principal symbol of A .
2. If $f(t) = \sum_{j=0}^K f_j t^j$ is a polynomial, then $f[A] = f(A)$, where $f(A) = \sum_j f_j A^j$.
3. $(f + g)[A] = f[A] + g[A]$ and $(fg)[A] = f[A]g[A]$.
4. If $B \in \Psi_{\text{cl}}^{\text{loc}}(U)$ and $[A, B] = 0$, then $[f[A], B] = 0$.

The identities in parts 2–4 are equalities of local operators; in particular, they include the $h^\infty \Psi^{-\infty}$ error. In fact, the operator $f[A]$ is only defined uniquely modulo $h^\infty \Psi^{-\infty}$.

Proof. 1. Follows immediately from (2.3.3).

2. Take an open set V compactly contained in U ; then there exists $\tilde{A} \in \Psi_{\text{cl}}^{\text{comp}}(M)$ such that $A = \tilde{A}$ microlocally on V . Since f is entire and \tilde{A} is compactly microlocalized, we can define $f(\tilde{A})$ by means of holomorphic functional calculus; it is a pseudodifferential operator representing $f[\tilde{A}]$. Now, $f(A) = f(\tilde{A})$ microlocally on V by properties of multiplication of pseudodifferential operators and $f[A] = f[\tilde{A}]$ microlocally on V by (2.3.3); therefore, $f(A) = f[A]$ microlocally on V . Since V was arbitrary, we have $f(A) = f[A]$ microlocally on the whole U .

3. We only prove the second statement. It suffices to show that for every coordinate system on M , the full symbols of $(fg)[A]$ and $f[A]g[A]$ are equal. However, the terms in the asymptotic decomposition of the full symbol of $(fg)[A] - f[A]g[A]$ at (x, ξ) only depend on the derivatives of the full symbol of A at (x, ξ) and the derivatives of f and g at $a_0(x, \xi)$. Therefore, it suffices to consider the case when f and g are polynomials. In this case, we can use the previous part of the proposition and the fact that $f(A)g(A) = (fg)(A)$.

4. This is proven similarly to the previous part, using the fact that $[A, B] = 0$ yields $[f(A), B] = 0$ for every polynomial f . \square

Finally, under certain conditions on the growth of f and the symbol of A at infinity, $f[A]$ is a globally defined operator:

Proposition 2.3.4. *Assume that $A \in \Psi_{\text{cl}}^k(M)$, with $k \geq 0$, and that A is elliptic in the class Ψ^k outside of a compact subset of T^*M . Also, assume that $f \in C^\infty(\mathbb{R})$ is a symbol of order s , in the sense that for each l , there exists a constant C_l such that*

$$|f^{(l)}(t)| \leq C_l \langle t \rangle^{s-l}, \quad t \in \mathbb{R}.$$

Then $f[A]$ is represented by an operator in $\Psi_{\text{cl}}^{sk}(M)$.

Proof. We use (2.3.3); by Proposition 2.3.2, the symbol b_{jM} lies in S^{kM-j} . Since f is a symbol of order s , $f^{(M)}$ is a symbol of order $s - M$. Then, since $a_0 \in S^k$ is elliptic outside of a compact set and $k \geq 0$, we have $f^{(M)} \circ a_0 \in S^{k(s-M)}$. It follows that each term in (2.3.3) lies in S^{sk-j} ; therefore, this asymptotic sum gives an element of Ψ_{cl}^{sk} . \square

2.3.3 Quantizing canonical transformations

Assume that M_1 and M_2 are two manifolds of the same dimension. Recall that the symplectic form ω_j^S on T^*M_j is given by $\omega_j^S = d\sigma_j^S$, where $\sigma_j^S = \xi dx$ is the canonical 1-form. We let $K_j \subset T^*M_j$ be compact and assume that $\Phi : T^*M_1 \rightarrow T^*M_2$ is a symplectomorphism defined in a neighborhood of K_1 and such that $\Phi(K_1) = K_2$. Then the form $\sigma_1^S - \Phi^*\sigma_2^S$ is closed; we say that Φ is an exact symplectomorphism if this form is exact. Define the classical action over a closed curve in T^*M_j as the integral of σ_j^S over this curve; then Φ is exact if and only if for each closed curve γ in the domain of Φ , the classical action over γ is equal to the classical action over $\Phi \circ \gamma$. We can quantize exact symplectomorphisms as follows:

Proposition 2.3.5. *Assume that Φ is an exact symplectomorphism. Then there exist h -dependent families of operators*

$$B_1 : \mathcal{D}'(M_1) \rightarrow C_0^\infty(M_2), \quad B_2 : \mathcal{D}'(M_2) \rightarrow C_0^\infty(M_1)$$

such that:

1. Each B_j is compactly microlocalized and has operator norm $O(1)$; moreover, $\text{WF}_h(B_1)$ is contained in the graph of Φ and $\text{WF}_h(B_2)$ is contained in the graph of Φ^{-1} .

2. The operators B_1B_2 and B_2B_1 are equal to the identity microlocally near $K_2 \times K_2$ and $K_1 \times K_1$, respectively.

3. For each $P \in \Psi_{\text{cl}}(M_1)$, there exists $Q \in \Psi_{\text{cl}}(M_2)$ that is intertwined with P via B_1 and B_2 :

$$B_1P = QB_1, \quad PB_2 = B_2Q$$

microlocally near $K_1 \times K_2$ and $K_2 \times K_1$, respectively. Similarly, for each $Q \in \Psi_{\text{cl}}(M_2)$ there exists $P \in \Psi_{\text{cl}}(M_1)$ intertwined with it. Finally, if P and Q are intertwined via B_1 and B_2 and p and q are their principal symbols, then $p = q \circ \Phi$ near K_1 .

If the properties 1–3 hold, we say that the pair (B_1, B_2) quantizes the canonical transformation Φ near $K_1 \times K_2$.

Proof. We take B_1, B_2 to be semiclassical Fourier integral operators associated with Φ and Φ^{-1} , respectively; their symbols are taken compactly supported and elliptic in a neighborhood of $K_1 \times K_2$. The existence of globally defined elliptic symbols follows from the exactness of Φ ; the rest follows from calculus of Fourier integral operators. See [62, Chapter 8] or [130, Chapter 2] for more details. \square

Note that the operators B_1 and B_2 quantizing a given canonical transformation are not unique. In fact, if $X_j \in \Psi_{\text{cl}}^{\text{comp}}(M_j)$ are elliptic near K_j and $Y_j \in \Psi_{\text{cl}}^{\text{comp}}(M_j)$ are their inverses near K_j , then $(X_2B_1X_1, Y_1B_2Y_2)$ also quantizes Φ ; moreover, P is intertwined with Q via the new pair of operators if and only if X_1PY_1 is intertwined with Y_2QX_2 via (B_1, B_2) .

We now study microlocal properties of Schrödinger propagators. Take $A \in \Psi_{\text{cl}}^{\text{comp}}(M)$ with compactly supported Schwartz kernel and let a_0 be its principal symbol; we assume that a_0 is real-valued. In this case the Hamiltonian flow $\exp(tH_{a_0})$, $t \in \mathbb{R}$, is a family of symplectomorphisms defined on the whole T^*M ; it is the identity outside of $\text{supp } a_0$. Moreover, $\exp(tH_{a_0})$ is exact; indeed, if $V = H_{a_0}$, then by Cartan's formula

$$\mathcal{L}_V \sigma^S = d(i_V \sigma^S) + i_V d(\sigma^S) = d(i_V \sigma^S - a_0)$$

is exact. Therefore,

$$d_t \exp(tV)^* \sigma^S = \exp(tV)^* \mathcal{L}_V \sigma^S$$

is exact and $\exp(tV)^* \sigma^S - \sigma^S$ is exact for all t .

For each t , define the operator $\exp(itA/h)$ as the solution to the Schrödinger equation

$$hD_t \exp(itA/h) = A \exp(itA/h) = \exp(itA/h)A$$

in the algebra of bounded operators on $L^2(M)$, with the initial condition $\exp(i0A/h) = I$. Such a family exists since A is a bounded operator on $L^2(M)$ for all h . Here are some of its properties (see also [137, Chapter 10]):

Proposition 2.3.6. 1. The operator $\exp(itA/h) - I$ is compactly microlocalized and has operator norm $O(1)$.

2. If $A, B \in \Psi_{\text{cl}}^{\text{comp}}$ have real-valued principal symbols and $[A, B] = O(h^\infty)$, then

$$[\exp(itA/h), B] = O(h^\infty), \quad \exp(it(A+B)/h) = \exp(itA/h)\exp(itB/h) + O(h^\infty).$$

(We do not specify the functional spaces as the estimated families of operators are compactly microlocalized, so all Sobolev norms are equivalent.) In particular, if $B = O(h^\infty)$, then the propagators of A and $A+B$ are the same modulo $O(h^\infty)$.

3. Let $P \in \Psi_{\text{cl}}$ and take

$$P_t = \exp(itA/h)P\exp(-itA/h).$$

Then P_t is pseudodifferential and its full symbol depends smoothly on t . The principal symbol of P_t is $p_0 \circ \exp(tH_{a_0})$, where p_0 is the principal symbol of P ; moreover,

$$\text{WF}_h(P_t) = \exp(-tH_{a_0})(\text{WF}_h(P)).$$

4. Let $K \subset T^*M$ be a compact set invariant under the Hamiltonian flow of a_0 . If $X \in \Psi_{\text{cl}}^{\text{comp}}$ is equal to the identity microlocally near K , then the pair

$$(X\exp(-itA/h), X\exp(itA/h))$$

quantizes the canonical transformation $\exp(tH_{a_0})$ near $K \times K$. Moreover, if $P, Q \in \Psi_{\text{cl}}^{\text{comp}}$ are intertwined via these two operators, then $Q = \exp(-itA/h)P\exp(itA/h)$ microlocally near K .

5. Assume that V is a compactly supported vector field on M , and let $\exp(tV) : M \rightarrow M$ be the corresponding flow, defined for all t ; denote by $\exp(tV)^*$ the pull-back operator, acting on functions on M . Let $K \subset T^*M$ be compact and invariant under the flow of V , and $X \in \Psi_{\text{cl}}^{\text{comp}}$ have real-valued principal symbol and be equal to the identity microlocally near K ; consider $(hV/i)X \in \Psi_{\text{cl}}^{\text{comp}}$. Then for each t ,

$$\exp(it(hV/i)X/h) = \exp(tV)^*$$

microlocally near $K \times K$.

The statements above are true locally uniformly in t .

Proof. 1. First, take $u \in L^2(M)$; then, since the principal symbol of A is real-valued, we have $\|A - A^*\|_{L^2 \rightarrow L^2} = O(h)$ and thus

$$D_t \|\exp(itA/h)u\|_{L^2}^2 = h^{-1}((A - A^*)\exp(itA/h)u, \exp(itA/h)u)_{L^2} = O(\|\exp(itA/h)u\|_{L^2}^2);$$

therefore, $\exp(itA/h)$ is tempered:

$$\|\exp(itA/h)\|_{L^2 \rightarrow L^2} = O(e^{C|t|}).$$

The rest follows from the identity

$$\exp(itA/h) = I + \frac{it}{h}A + \frac{i}{h}A \int_0^t (t-s)\exp(isA/h) ds \cdot \frac{i}{h}A.$$

2. We have

$$D_t(\exp(itA/h)B \exp(-itA/h)) = h^{-1} \exp(itA/h)[A, B] \exp(-itA/h) = O(h^\infty);$$

this proves the first identity. The second one is proved in a similar fashion:

$$D_t(\exp(-it(A+B)/h) \exp(itA/h) \exp(itB/h)) = O(h^\infty).$$

3. We construct a family \tilde{P}_t of classical pseudodifferential operators, each equal to P microlocally outside of a compact set, solving the initial-value problem

$$D_t \tilde{P}_t = h^{-1}[A, \tilde{P}_t] + O(h^\infty), \quad \tilde{P}_0 = P + O(h^\infty).$$

For that, we can write a countable system of equations on the components of the full symbol of \tilde{P}_t . In particular, if $p(t)$ is the principal symbol of \tilde{P}_t , we get

$$\partial_t p(t) = \{a_0, p(t)\} = H_{a_0} p(t);$$

it follows that $p(t) = p_0 \circ \exp(tH_{a_0})$. Similarly we can recover the wavefront set of \tilde{P}_t from that of P . Now,

$$\partial_t(\exp(-itA/h) \tilde{P}_t \exp(itA/h)) = O(h^\infty);$$

therefore, $P_t = \tilde{P}_t + O(h^\infty)$.

4. Since X is compactly microlocalized, so are the operators $B_1 = X \exp(-itA/h)$ and $B_2 = X \exp(itA/h)$. Next, if $Y_2, Y_1 \in \Psi_{\text{cl}}^{\text{comp}}$, then

$$Y_2 B_1 Y_1 = Y_2 X (\exp(-itA/h) Y_1 \exp(itA/h)) \exp(-itA/h);$$

using our knowledge of the wavefront set of the operator in brackets, we see that this is $O(h^\infty)$ if

$$\text{WF}_h(Y_2) \cap \exp(tH_{a_0}) \text{WF}_h(Y_1) = \emptyset.$$

Therefore, $\text{WF}_h(B_1)$ is contained in the graph of $\exp(tH_{a_0})$; similarly, $\text{WF}_h(B_2)$ is contained in the graph of $\exp(-tH_{a_0})$. Next,

$$B_1 B_2 = X(\exp(-itA/h) X \exp(itA/h));$$

however, the operator in brackets is the identity microlocally near K , as X is the identity microlocally near K and K is invariant under $\exp(tH_{a_0})$. Therefore, $B_1 B_2$ is the identity microlocally near K . The intertwining property is proved in a similar fashion.

5. We have

$$\partial_t(\exp(tVX) \exp(-tV)^*) = \exp(tVX) V (X - I) \exp(-tV)^* = O(h^\infty)$$

microlocally near $K \times K$. □

Finally, we consider the special case $a_0 = 0$; in other words, we study $\exp(itA)$, where $A \in \Psi_{\text{cl}}^{\text{comp}}$. Since the associated canonical transformation is the identity, it is not unexpected that $\exp(itA)$ is a pseudodifferential operator:

Proposition 2.3.7. *Let a_1 be the principal symbol of A . Then:*

1. $\exp(itA) - I \in \Psi_{\text{cl}}^{\text{comp}}$ and the principal symbol of $\exp(itA)$ equals e^{ita_1} . Moreover, if $A_1 = A_2$ microlocally in some open set, then $\exp(itA_1) = \exp(itA_2)$ microlocally in the same set.

2. For any $P \in \Psi_{\text{cl}}^{\text{comp}}$, we have the following asymptotic sum:

$$\exp(itA)P \exp(-itA) \sim \sum_{j \geq 0} \frac{(it \operatorname{ad}_A)^j P}{j!},$$

where $\operatorname{ad}_A Q = [A, Q]$ for every Q .

3. If $U \subset T^*M$ is connected and $\exp(iA) = I$ microlocally in U , then $A = 2\pi l$ microlocally in U , where l is an integer constant.

Proof. 1. We can find a family of pseudodifferential operators B_t solving

$$\partial_t B_t = iAB_t + O(h^\infty), \quad B_0 = I,$$

by subsequently finding each member of the asymptotic decomposition of the full symbol of B_t . Then

$$\partial_t(\exp(-itA)B_t) = O(h^\infty);$$

therefore, $\exp(itA) = B_t + O(h^\infty)$. The properties of B_t can be verified directly.

2. Follows directly from the equation

$$\partial_t(\exp(itA)P \exp(-itA)) = i \operatorname{ad}_A(\exp(itA)P \exp(-itA)).$$

3. By calculating the principal symbol of $\exp(iA)$, we see that a_1 has to be equal to $2\pi l$ in U for some constant $l \in \mathbb{Z}$. Subtracting this constant, we reduce to the case when $A = O(h)$. However, if $A = O(h^N)$ for some $N \geq 1$, then $\exp(iA) = I + iA + O(h^{N+1})$; by induction, we get $A = O(h^N)$ microlocally in U for all N . \square

2.3.4 Integrable systems

Assume that M is a two-dimensional manifold and p_1, p_2 are two real-valued functions defined on an open set $U \subset T^*M$ such that:

- $\{p_1, p_2\} = 0$;
- for $\mathbf{p} = (p_1, p_2) : U \rightarrow \mathbb{R}^2$ and each $\rho \in \mathbf{p}(U)$, the set $\mathbf{p}^{-1}(\rho)$ is compact and connected.

We call such \mathbf{p} an integrable system. Note that if $V \subset \mathbb{R}^2$ is open and intersects $\mathbf{p}(U)$, and $F : V \rightarrow \mathbb{R}^2$ is a diffeomorphism onto its image, then $F(\mathbf{p})$ is an integrable system on $\mathbf{p}^{-1}(V)$.

We say that an integrable system $\mathbf{p} : U \rightarrow \mathbb{R}^2$ is nondegenerate on U , if the differentials of p_1 and p_2 are linearly independent everywhere on U . The following two propositions describe the normal form for nondegenerate integrable systems:

Proposition 2.3.8. *Assume that the integrable system \mathbf{p} is nondegenerate on U . Then:*

1. *For each $\rho \in \mathbf{p}(U)$, the set $\mathbf{p}^{-1}(\rho) \subset T^*M$ is a Lagrangian torus. Moreover, the family of diffeomorphisms*

$$\phi_t = \exp(t_1 H_{p_1} + t_2 H_{p_2}), \quad t = (t_1, t_2) \in \mathbb{R}^2,$$

defines a transitive action of \mathbb{R}^2 on $\mathbf{p}^{-1}(\rho)$. The kernel of this action is a rank two lattice depending smoothly on ρ ; we call it the periodicity lattice (at ρ).

2. *For each $\rho_0 \in \mathbf{p}(U)$, there exists a neighborhood $V(\rho_0)$ and a diffeomorphism $F : V \rightarrow \mathbb{R}^2$ onto its image such that the nondegenerate integrable system $F(\mathbf{p})$ has periodicity lattice $2\pi\mathbb{Z}^2$ at every point. Moreover, if the Hamiltonian flow of p_2 is periodic with minimal period 2π , we can take the second component of $F(\mathbf{p})$ to be p_2 .*

3. *Assume that $V \subset \mathbf{p}(U)$ is open and connected and $F_1, F_2 : V \rightarrow \mathbb{R}^2$ are two maps satisfying the conditions of part 2. Then there exist $A \in \text{GL}(2, \mathbb{Z})$ and $b \in \mathbb{R}^2$ such that $F_2 = A \cdot F_1 + b$.*

Proof. This is a version of Arnold–Liouville theorem; see [43, §1] for the proof. \square

Proposition 2.3.9. *Assume that $\mathbf{p} : U \rightarrow \mathbb{R}^2$, $\mathbf{p}' : U' \rightarrow \mathbb{R}^2$, are nondegenerate integrable systems with periodicity lattices $2\pi\mathbb{Z}^2$ at every point; here $U \subset T^*M$, $U' \subset T^*M'$. Take $\rho_0 \in \mathbf{p}(U) \cap \mathbf{p}'(U')$. Then:*

1. *There exists a symplectomorphism Φ from a neighborhood of $\mathbf{p}^{-1}(\rho_0)$ in T^*M onto a neighborhood of $(\mathbf{p}')^{-1}(\rho_0)$ in T^*M' such that $\mathbf{p} = \mathbf{p}' \circ \Phi$.*

2. *Φ is exact, as defined in §2.3.3, if and only if*

$$\int_{\gamma_j} \sigma^S = \int_{\gamma'_j} \sigma'^S, \quad j = 1, 2,$$

where γ_j and γ'_j are some fixed (2π -periodic) Hamiltonian trajectories of p_j on $\mathbf{p}^{-1}(\rho_0)$ and p'_j on $(\mathbf{p}')^{-1}(\rho_0)$, respectively.

Proof. Part 1 again follows from Arnold–Liouville theorem. For part 2, we use that the closed 1-form $\sigma^S - \Phi^* \sigma'^S$ on a tubular neighborhood of $\mathbf{p}^{-1}(\rho_0)$ is exact if and only if its integral over each γ_j is zero. Since γ_j lie in $\mathbf{p}^{-1}(\rho_0)$ and the restriction of $d\sigma^S = \omega^S$ to $\mathbf{p}^{-1}(\rho_0)$ is zero, we may shift γ_j to make both of them start at a fixed point $(x_0, \xi_0) \in \mathbf{p}^{-1}(\rho_0)$. Similarly, we may assume that both γ'_j start at $\Phi(x_0, \xi_0)$. But in this case $\gamma'_j = \Phi \circ \gamma_j$ and

$$\int_{\gamma_j} \sigma^S - \Phi^* \sigma'^S = \int_{\gamma_j} \sigma^S - \int_{\gamma'_j} \sigma'^S,$$

which finishes the proof. \square

Next, we establish normal form for one-dimensional Hamiltonian systems with one degenerate point. For that, consider $\mathbb{R}_{x,\xi}^2$ with the standard symplectic form $d\xi \wedge dx$, and define $\zeta = (x^2 + \xi^2)/2$; then ζ has unique critical point at zero and its Hamiltonian flow is 2π -periodic.

Proposition 2.3.10. *Assume that $p(x, \xi)$ is a real-valued function defined on an open subset of \mathbb{R}^2 and for some $A \in \mathbb{R}$,*

- *the set $K_A = \{p \leq A\}$ is compact;*
- *p has exactly one critical point (x_0, ξ_0) in K_A , $p(x_0, \xi_0) < A$, and the Hessian of p at (x_0, ξ_0) is positive definite.*

Then there exists a smooth function F on the segment $[p(x_0, \xi_0), A]$, with $F' > 0$ everywhere and $F(p(x_0, \xi_0)) = 0$, and a symplectomorphism Ψ from K_A onto the disc $\{\zeta \leq F(A)\} \subset \mathbb{R}^2$ such that $F(p) = \zeta \circ \Psi$. Moreover, $F'(p(x_0, \xi_0)) = (\det \nabla^2 p(x_0, \xi_0))^{-1/2}$. If p depends smoothly on some parameter Z , then F and Ψ can be chosen locally to depend smoothly on this parameter as well.

Proof. Without loss of generality, we may assume that $p(x_0, \xi_0) = 0$. Recall that in one dimension, symplectomorphisms are diffeomorphisms that preserve both area and orientation. By Morse lemma, there exists an orientation preserving diffeomorphism Θ from a neighborhood of (x_0, ξ_0) onto a neighborhood of the origin such that $p = \zeta \circ \Theta$. Using the gradient flow of p , we can extend Θ to a diffeomorphism from K_A to the disc $\{\zeta \leq A\}$ such that $p = \zeta \circ \Theta$. Let J be the Jacobian of Θ^{-1} ; then the integral of J inside the disc $\{\zeta \leq a\}$ is a smooth function of a . Therefore, there exists unique function F smooth on $[0, A]$ such that $F' > 0$ everywhere, $F(0) = 0$, and the integral of J inside the disc $\{F(\zeta) \leq a\}$, that is, the area of $\Theta^{-1}(\{F(\zeta) \leq a\}) = \{F(p) \leq a\} \subset K_A$, is equal to $2\pi a$.

Let $\tilde{\Theta}$ be a diffeomorphism from K_A onto $\{\zeta \leq F(A)\}$ such that $F(p) = \zeta \circ \tilde{\Theta}$ (constructed as in the previous paragraph, taking $F(p)$ in place of p) and let \tilde{J} be the Jacobian of $\tilde{\Theta}^{-1}$. We know that for $0 \leq a \leq F(A)$, the integral of $\tilde{J} - 1$ over $\{\zeta \leq a\}$ is equal to 0. Introduce polar coordinates (r, φ) ; then there exists a smooth function ψ such that $\tilde{J} = 1 + \partial_\varphi \psi$ (see Proposition 2.4.7). The transformation

$$\tilde{\Psi} : (r, \varphi) \mapsto (r, \varphi + \psi)$$

is a diffeomorphism from $\{\zeta \leq F(A)\}$ to itself and has Jacobian \tilde{J} ; it remains to put $\Psi = \tilde{\Psi} \circ \tilde{\Theta}$. To compute $F'(p_0(x_0, \xi_0))$, we can compare the Hessians of $F(p)$ and $\zeta \circ \tilde{\Theta}$ at (x_0, ξ_0) .

The function F is uniquely determined by p and thus will depend smoothly on Z . As for Ψ , we first note that $\tilde{\Theta}$ was constructed using Morse lemma and thus can be chosen locally to depend smoothly on Z (see for example [137, Proof of Theorem 3.15]). Next,

we can fix ψ by requiring that it integrates to zero over each circle centered at the origin (see Proposition 2.4.7); then ψ , and thus $\tilde{\Psi}$, will depend smoothly on Z . \square

2.4 Angular problem

2.4.1 Outline of the proof

Consider the semiclassical differential operators (using the notation of (2.2.11))

$$\begin{aligned} P_1(\tilde{\omega}, \tilde{\nu}; h) &= h^2 P_\theta(\omega) = \frac{1}{\sin \theta} (hD_\theta)(\Delta_\theta \sin \theta \cdot hD_\theta) \\ &\quad + \frac{(1 + \alpha)^2}{\Delta_\theta \sin^2 \theta} (a(\tilde{\omega} + ih\tilde{\nu}) \sin^2 \theta - hD_\varphi)^2, \\ P_2(h) &= hD_\varphi \end{aligned}$$

on the sphere \mathbb{S}^2 . Then (ω, λ, k) is a pole of R_θ if and only if $(\tilde{\lambda} + ih\tilde{\mu}, \tilde{k})$ lies in the joint spectrum of the operators (P_1, P_2) (see Definition 2.A.1). For $a = 0$, P_1 is the Laplace–Beltrami operator on the round sphere (multiplied by $-h^2$); therefore, the joint spectrum of (P_1, P_2) is given by the spherical harmonics $(\tilde{l}(\tilde{l} + h), \tilde{k})$, $\tilde{k}, \tilde{l} \in h\mathbb{Z}$, $|\tilde{k}| \leq \tilde{l}$ (see for example [123, §8.4]). In the end of this subsection, we give a short description of which parts of the angular problem are simplified for $a = 0$. For general small a , we will prove that the joint spectrum is characterized by the following

Proposition 2.4.1. *Let $\tilde{\omega}, \tilde{\nu}$ satisfy (2.2.14); we suppress dependence of the operators and symbols on these parameters. Consider⁷*

$$\begin{aligned} \tilde{K} &= \{(\tilde{\lambda}, \tilde{k}) \mid C_\theta^{-1} \leq \tilde{\lambda} \leq C_\theta, \tilde{\lambda} \geq (1 + \alpha)^2(\tilde{k} - a\tilde{\omega})^2\} \subset \mathbb{R}^2, \\ \tilde{K}_\pm &= \{(\tilde{\lambda}, \tilde{k}) \in \tilde{K} \mid (1 + \alpha)(\tilde{k} - a\tilde{\omega}) = \pm \sqrt{\tilde{\lambda}}\}. \end{aligned}$$

Then there exist functions $G_\pm(\tilde{\lambda}, \tilde{k}; h)$ such that:

1. G_\pm is a complex valued classical symbol in h , smooth in a fixed neighborhood of \tilde{K} . For $(\tilde{\lambda}, \tilde{k})$ near \tilde{K} and $|\tilde{\mu}| \leq C_\theta$, we can define $G_\pm(\tilde{\lambda} + ih\tilde{\mu}, \tilde{k})$ by means of an asymptotic (analytic) Taylor series for G_\pm at $(\tilde{\lambda}, \tilde{k})$.

2. For $a = 0$, $G_\pm(\tilde{\lambda}, \tilde{k}; h) = -h/2 + \sqrt{\tilde{\lambda} + h^2/4} \mp \tilde{k}$.

3. $G_-(\tilde{\lambda}, \tilde{k}; h) - G_+(\tilde{\lambda}, \tilde{k}; h) = 2\tilde{k}$.

4. Let F_\pm be the principal symbol of G_\pm . Then F_\pm is real-valued, $\partial_{\tilde{\lambda}} F_\pm > 0$ and $\mp \partial_{\tilde{k}} F_\pm > 0$ on \tilde{K} , and $F_\pm|_{\tilde{K}_\pm} = 0$.

5. For h small enough, the set of elements $(\tilde{\lambda} + ih\tilde{\mu}, \tilde{k})$ of the joint spectrum of (P_1, P_2) satisfying (2.2.14) lies within $O(h)$ of \tilde{K} and coincides modulo $O(h^\infty)$ with the set of solutions

⁷The spectral set \tilde{K} used here should not be confused with the trapped set \tilde{K} used in Chapter 4.

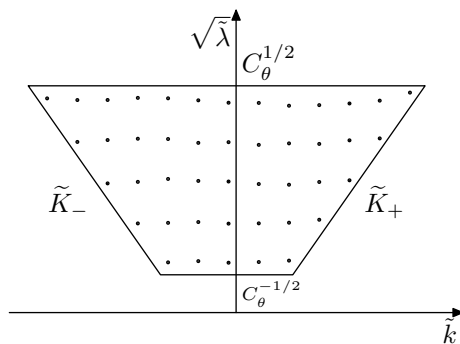

Figure 2.2: The joint spectrum and the set \tilde{K} .

to the quantization conditions

$$\tilde{k} \in h\mathbb{Z}, \quad G_{\pm}(\tilde{\lambda} + ih\tilde{\mu}, \tilde{k}) \in h\mathbb{N};$$

here \mathbb{N} is the set of nonnegative integers. Note that the conditions $G_+ \in \mathbb{Z}$ and $G_- \in \mathbb{Z}$ are equivalent; however, we also require that both G_+ and G_- be nonnegative. Moreover, the corresponding joint eigenspaces are one-dimensional.

Proposition 2.2.7 follows from the proof of Proposition 2.4.1. In fact, the symbol $\mathcal{F}^{\theta}(\tilde{l}, \tilde{\omega}, \tilde{\nu}, \tilde{k}; h)$ is defined as the solution $\tilde{\lambda} + ih\tilde{\mu}$ to the equation

$$G_+(\tilde{\lambda} + ih\tilde{\mu}, \tilde{k}, \tilde{\omega} + ih\tilde{\nu}; h) = \tilde{l} - \tilde{k};$$

this proves part (1) of Definition 2.2.2. The resolvent estimates are an immediate corollary of the ones stated in Proposition 2.4.8 below. The decomposition of \mathcal{F}_0^{θ} at $a = 0$ follows from Proposition 2.4.4.

We now give the schema of the proof of Proposition 2.4.1. Let p_{j0} be the principal symbol of P_j ; note that both p_{10} and p_{20} are real-valued; also, define $\mathbf{p} = (p_{10}, p_{20}) : T^*\mathbb{S}^2 \rightarrow \mathbb{R}^2$. In §2.4.2, we construct the principal parts F_{\pm} of the quantization symbols globally in \tilde{K} , and show that the intersection of the image of \mathbf{p} with $\{C_{\theta}^{-1} \leq \tilde{\lambda} \leq C_{\theta}\}$ is exactly \tilde{K} . Using the theory of integrable systems described in §2.3.4, we then construct local symplectomorphisms conjugating $(F_{\pm}(\mathbf{p}), p_{20})$ away from \tilde{K}_{\mp} to the system (ζ, η) on $T^*\mathcal{M}$, where $\mathcal{M} = \mathbb{R}_x \times \mathbb{S}_y^1$ is called the model space, (ξ, η) are the momenta corresponding to (x, y) , and

$$\zeta = \frac{x^2 + \xi^2}{2}.$$

Note that the integrable system (ζ, η) is nondegenerate on $\{\zeta > 0\}$ with periodicity lattice $2\pi\mathbb{Z}^2$, and $d\zeta = 0$ on $\{\zeta = 0\}$.

Next, we take $(\tilde{\lambda}_0, \tilde{k}_0) \in \tilde{K}$ and show that joint eigenvalues in a certain h -independent neighborhood of this point are given by a quantization condition. For this, we first use

Egorov's theorem and the symplectomorphisms constructed in §2.4.2 to conjugate P_1, P_2 microlocally near $\mathbf{p}^{-1}(\tilde{\lambda}_0, \tilde{k}_0)$ to some pseudodifferential operators Q_1, Q_2 on \mathcal{M} . The principal symbols of Q_j are real-valued functions of (ζ, η) only; in §2.4.3, we use Moser averaging to further conjugate Q_1, Q_2 by elliptic pseudodifferential operators so that the full symbols of Q_j depend only on (ζ, η) . In §2.4.4, we use spectral theory to construct a local Grushin problem for (Q_1, Q_2) , which we can conjugate back to a local Grushin problem for (P_1, P_2) ; then, we can apply the results of Appendix 2.A to obtain local quantization conditions (Proposition 2.4.8). To pass from these local conditions to the global one, we use

Proposition 2.4.2. *Assume that $G_j(\tilde{\lambda}, \tilde{k}; h)$ are two complex-valued classical symbols in h defined in some open set $U \subset \mathbb{R}^2$, their principal symbols are both equal to some real-valued $F(\tilde{\lambda}, \tilde{k})$, with $\partial_{\tilde{\lambda}} F \neq 0$ everywhere and $\{F \geq 0\}$ convex, and solution sets to quantization conditions*

$$\tilde{k} \in h\mathbb{Z}, \quad G_j(\tilde{\lambda} + ih\tilde{\mu}, \tilde{k}) \in h\mathbb{N}$$

in the region $(\tilde{\lambda}, \tilde{k}) \in U$, $\tilde{\mu} = O(1)$ coincide modulo $O(h^\infty)$. Then $G_1 - G_2 = hl + O(h^\infty)$ on $\{F \geq 0\}$ for some constant $l \in \mathbb{Z}$. Moreover, if $\{F = 0\} \cap U \neq \emptyset$, then $l = 0$.

Proof. Assume that $(\tilde{\lambda}_1, \tilde{k}_1) \in \{F \geq 0\}$. Then for every h , there is a solution $(\tilde{\lambda}(h) + ih\tilde{\mu}(h), \tilde{k}(h))$ to the quantization conditions within $O(h)$ of $(\tilde{\lambda}_1, \tilde{k}_1)$; we know that

$$G_j(\tilde{\lambda}(h) + ih\tilde{\mu}(h), \tilde{k}(h)) \in h\mathbb{Z} + O(h^\infty), \quad j = 1, 2,$$

and thus $(G_1 - G_2)(\tilde{\lambda}(h) + ih\tilde{\mu}(h), \tilde{k}(h)) = hl(h) + O(h^\infty)$, for some $l(h) \in \mathbb{Z}$. Since $G_1 - G_2 = O(h)$ in particular in C^1 , we have

$$|(G_1 - G_2)(\tilde{\lambda}_1, \tilde{k}_1) - hl(h)| = O(h^2).$$

Therefore, $l(h)$ is constant for h small enough and it is equal to the difference of subprincipal symbols of G_1 and G_2 at $(\tilde{\lambda}_1, \tilde{k}_1)$. It follows that $l(h)$ is independent of $(\tilde{\lambda}_1, \tilde{k}_1)$; we can subtract it from one of the symbols to reduce to the case when $G_1 - G_2 = O(h^2)$. The analysis in the beginning of this proof then shows that

$$\|G_1 - G_2\|_{C(F \geq 0)} = O(h\|G_1 - G_2\|_{C^1(F \geq 0)} + h^\infty).$$

Arguing by induction, we get $G_1 - G_2 = O(h^N)$ for all N . The last statement follows directly by taking solutions to the quantization conditions with $G_j = 0$ and requiring that they satisfy the quantization conditions $G_{3-j} \geq 0$. \square

We can now cover \tilde{K} by a finite family of open sets, on each of which there exists a local quantization condition. Using Proposition 2.4.2 and starting from \tilde{K}_\pm , we can modify the local quantization conditions and piece them together to get unique (modulo h^∞) global G_\pm . The joint spectrum of (P_1, P_2) in a neighborhood of \tilde{K} is then given by the global quantization condition; the joint spectrum outside of this neighborhood, but satisfying (2.2.14), is empty by part 2 of Proposition 2.4.8.

Also, the principal symbol of $G_- - G_+$ is equal to $2\tilde{k}$; therefore, $G_- - G_+ - 2\tilde{k}$ is equal to $l\tilde{h}$ for some fixed $l \in \mathbb{Z}$. However, G_\pm depend smoothly on a and thus it is enough to prove that $l = 0$ for $a = 0$; in the latter case, the symbols G_\pm are computed explicitly from the spectrum of Laplacian on the round sphere. (Without such a reference point, one would need to analyse the subprincipal symbols of G_\pm using the Maslov index.) This finishes the proof of Proposition 2.4.1.

Finally, let us outline the argument in the special case $a = 0$ and indicate which parts of the construction are simplified. The formulas below are not used in the general argument; we provide them for the reader's convenience. The principal symbol p_{10} of P_1 is just the square of the norm on $T^*\mathbb{S}^2$ generated by the round metric:

$$p_{10} = \xi_\theta^2 + \frac{\xi_\varphi^2}{\sin^2 \theta}.$$

The set $\mathbf{p}^{-1}(\tilde{\lambda}, \tilde{k})$ consists of all cotangent vectors with length $\sqrt{\tilde{\lambda}}$ and momentum \tilde{k} ; therefore

- (1) for $\tilde{\lambda} \leq \tilde{k}^2$ (corresponding to the complement of \tilde{K}), the set $\mathbf{p}^{-1}(\tilde{\lambda}, \tilde{k})$ is empty;
- (2) for $\tilde{k} = \pm\sqrt{\tilde{\lambda}}$ (corresponding to \tilde{K}_\pm), the set $\mathbf{p}^{-1}(\tilde{\lambda}, \tilde{k})$ is a circle, consisting of covectors tangent to the equator with length $\sqrt{\tilde{\lambda}}$ and direction determined by the choice of sign;
- (3) for $\tilde{\lambda} > \tilde{k}^2$ (corresponding to the interior of \tilde{K}), the set $\mathbf{p}^{-1}(\tilde{\lambda}, \tilde{k})$ is a Liouville torus.

The principal parts F_\pm of the quantization symbols, constructed in Proposition 2.4.4, can be computed explicitly: $F_\pm = \sqrt{\tilde{\lambda}} \mp \tilde{k}$ (see the proof of part 2 of this Proposition). Then $F_\pm^{-1}(\zeta, \eta) = (\zeta \pm \eta)^2$. For $\pm\tilde{k} > 0$, the canonical transformation Φ_\pm from Proposition 2.4.5 can be taken in the form

$$\begin{aligned} & (\theta, \varphi, \xi_\theta, \xi_\varphi) \mapsto (x, y, \xi, \eta) \\ & = ((2p_{10})^{1/2}(\sqrt{p_{10}} \pm \xi_\varphi)^{-1/2} \cos \theta, \varphi + G, -2^{1/2}(\sqrt{p_{10}} \pm \xi_\varphi)^{-1/2} \sin \theta \xi_\theta, \xi_\varphi); \end{aligned} \quad (2.4.1)$$

here (x, y, ξ, η) are coordinates on $T^*\mathcal{M}$, with $\mathcal{M} = \mathbb{R}_x \times \mathbb{S}_y^1$ the model space. The function $G : T^*\mathbb{S}^2 \rightarrow \mathbb{S}^1$ here is given by

$$(\sqrt{p_{10}} \pm \xi_\varphi) \cos G = p_{10}^{1/2} \sin \theta \pm \frac{\xi_\varphi}{\sin \theta}, \quad (\sqrt{p_{10}} \pm \xi_\varphi) \sin G = \mp \cos \theta \xi_\theta.$$

In fact, the maps Φ_\pm defined in (2.4.1) extend smoothly to the poles $\{\sin \theta = 0\}$ of the sphere and satisfy the conditions of Proposition 2.4.5 on the complement of the opposite equator $\{\theta = \pi/2, \xi_\theta = 0, \xi_\varphi = \mp\sqrt{\tilde{\lambda}}\}$.

One can then conjugate the operators P_1, P_2 to some model operators Q_1, Q_2 as in Proposition 2.4.6. To bring the subprincipal terms in Q_j to normal form, one still needs Moser averaging. Once the normal form of Proposition 2.4.6 is obtained, it is possible to use the ellipticity of $\mathbf{p} - (\tilde{\lambda}, \tilde{k})$ away from $\mathbf{p}^{-1}(\tilde{\lambda}, \tilde{k})$ (as in Proposition 2.4.5) and spectral theory to obtain the quantization condition. The Grushin problem construction of §2.4.4 and Appendix 2.A.1 is not needed, as the operator P_1 is self-adjoint.

2.4.2 Hamiltonian flow

Let (θ, φ) be the spherical coordinates on \mathbb{S}^2 and let $(\xi_\theta, \xi_\varphi)$ be the corresponding momenta. Note that ξ_θ is defined away from the poles $\{\sin \theta = 0\}$, while ξ_φ is well-defined and smooth on the whole $T^*\mathbb{S}^2$. In the $(\theta, \varphi, \xi_\theta, \xi_\varphi)$ coordinates, the principal symbols of P_2 and P_1 are $p_{20} = \xi_\varphi$ and

$$p_{10}(\theta, \varphi, \xi_\theta, \xi_\varphi) = \Delta_\theta \xi_\theta^2 + \frac{(1 + \alpha)^2}{\Delta_\theta \sin^2 \theta} (\xi_\varphi - a\tilde{\omega} \sin^2 \theta)^2.$$

Since p_{10} does not depend on φ , we have

$$\{p_{10}, p_{20}\} = 0.$$

We would like to apply the results of §2.3.4 on integrable Hamiltonian systems to establish a normal form for $\mathbf{p} = (p_{10}, p_{20})$. First of all, we study the points where the integrable system \mathbf{p} is degenerate:

Proposition 2.4.3. *For a small enough,*

1. *For $C_\theta^{-1} \leq \tilde{\lambda} \leq C_\theta$, the set $\mathbf{p}^{-1}(\tilde{\lambda}, \tilde{k})$ is nonempty if and only if $(\tilde{\lambda}, \tilde{k}) \in \tilde{K}$.*
2. *The integrable system \mathbf{p} is nondegenerate on $\mathbf{p}^{-1}(\tilde{K})$, except at the equators*

$$E_\pm(\tilde{\lambda}) = \{\theta = \pi/2, \xi_\theta = 0, (1 + \alpha)(\xi_\varphi - a\tilde{\omega}) = \pm\sqrt{\tilde{\lambda}}\} \subset T^*\mathbb{S}^2, \quad C_\theta^{-1} \leq \tilde{\lambda} \leq C_\theta.$$

Moreover, $p_{10} = \tilde{\lambda}$ on $E_\pm(\tilde{\lambda})$ and the union of all $E_\pm(\tilde{\lambda})$ is equal to $\mathbf{p}^{-1}(\tilde{K}_\pm)$. Also,

$$dp_{10} = \pm 2(1 + \alpha)\sqrt{\tilde{\lambda}} dp_{20} \text{ on } E_\pm(\tilde{\lambda}). \quad (2.4.2)$$

Proof. We can verify directly the statements above for $a = 0$, and also (2.4.2) for all a . Then part 2 follows for small a by a perturbation argument; part 1 follows from part 2 by studying the extremum problem for ξ_φ restricted to $\{p_{10} = \tilde{\lambda}\}$. \square

Next, we construct the principal parts F_\pm of the quantization symbols globally:

Proposition 2.4.4. *For a small enough,*

1. *There exist unique smooth real-valued functions $F_\pm(\tilde{\lambda}, \tilde{k})$ on \tilde{K} such that $F_\pm|_{\tilde{K}_\pm} = 0$ and $(F_\pm(\mathbf{p}), p_{20})$ is a nondegenerate completely integrable system on $\mathbf{p}^{-1}(\tilde{K} \setminus (\tilde{K}_+ \cup \tilde{K}_-))$ with periodicity lattice $2\pi\mathbb{Z}^2$.*

2. *$\partial_{\tilde{\lambda}} F_\pm > 0$, $\mp \partial_{\tilde{k}} F_\pm > 0$, and $F_-(\tilde{\lambda}, \tilde{k}) - F_+(\tilde{\lambda}, \tilde{k}) = 2\tilde{k}$ on \tilde{K} . In particular, one can define the inverse $F_\pm^{-1}(\zeta, \tilde{k})$ of F_\pm in the $\tilde{\lambda}$ variable, with \tilde{k} as a parameter. Also, $F_\pm = \sqrt{\tilde{\lambda}} \mp \tilde{k}$ for $a = 0$ and $\partial_{\tilde{\lambda}} F_\pm = \pm(2\tilde{k})^{-1} + O(a^2)$ on \tilde{K}_\pm .*

3. *If $(\tilde{\lambda}, \tilde{k}) \in \tilde{K} \setminus (\tilde{K}_+ \cup \tilde{K}_-)$ and γ_\pm are some $(2\pi$ -periodic) trajectories of $F_\pm(\mathbf{p})$ on $\mathbf{p}^{-1}(\tilde{\lambda}, \tilde{k})$, then*

$$\int_{\gamma_\pm} \sigma^S = 2\pi F_\pm(\tilde{\lambda}, \tilde{k}). \quad (2.4.3)$$

Proof. 1. We first construct F_+ in a neighborhood of \tilde{K}_+ . In fact, we take small $\varepsilon_k > 0$ and define F_+ on the set

$$\tilde{K}_\varepsilon = \{(\tilde{\lambda}, \tilde{k}) \mid \tilde{k} \geq \varepsilon_k, (1 + \alpha)^2(\tilde{k} - a\tilde{\omega})^2 \leq \tilde{\lambda} \leq C_\theta\}.$$

We will pick ε_k small enough so that $\tilde{K}_+ \subset \tilde{K}_\varepsilon$; note, however, that \tilde{K}_ε does not lie in \tilde{K} . Moreover, we will construct a symplectomorphism Φ from $\mathbf{p}^{-1}(\tilde{K}_\varepsilon)$ onto a subset of $T^*\mathcal{M}$ such that $F_+(\mathbf{p}) \circ \Phi^{-1} = \zeta$ and $p_{20} \circ \Phi^{-1} = \eta$.

Note that $\xi_\varphi = 0$ on the poles of the sphere $\{\sin \theta = 0\}$; therefore, $(\theta, \varphi, \xi_\theta, \xi_\varphi)$ is a symplectic system of coordinates near $\mathbf{p}^{-1}(\tilde{K}_\varepsilon)$. Next, fix $\xi_\varphi \geq \varepsilon_k$ and consider p_{10} as a function of (θ, ξ_θ) ; then for a small enough, this function has a unique critical point $(0, 0)$ on the compact set $\{p_{10}(\cdot, \cdot, \xi_\varphi) \leq C_\theta\}$; the Hessian at this point is positive definite. Indeed, it is enough to verify these statements for $a = 0$ and check that $\partial_\theta p_{10} = \partial_{\xi_\theta} p_{10} = 0$ for $(\theta, \xi_\theta) = (\pi/2, 0)$ and small a . Now, we may apply Proposition 2.3.10 to the function $\{p_{10}(\cdot, \cdot, \xi_\varphi)\}$ and obtain a function $F_+(\tilde{\lambda}; \tilde{k})$ on \tilde{K}_ε such that $F_+|_{\tilde{K}_+} = 0$ and $\partial_{\tilde{\lambda}} F_+ > 0$ and a mapping

$$\Psi : (\theta, \xi_\theta, \xi_\varphi) \mapsto (\Psi_x(\theta, \xi_\theta, \xi_\varphi), \Psi_\xi(\theta, \xi_\theta, \xi_\varphi))$$

that defines a family of symplectomorphisms $(\theta, \xi_\theta) \mapsto (\Psi_x, \Psi_\xi)$, depending smoothly on the parameter ξ_φ , and

$$F_+(p_{10}(\theta, \xi_\theta, \xi_\varphi), \xi_\varphi) = \frac{1}{2}(\Psi_x(\theta, \xi_\theta, \xi_\varphi)^2 + \Psi_\xi(\theta, \xi_\theta, \xi_\varphi)^2), \quad (\theta, \xi_\theta, \xi_\varphi) \in \mathbf{p}^{-1}(\tilde{K}_\varepsilon).$$

Now, define $\Phi : (\theta, \varphi, \xi_\theta, \xi_\varphi) \mapsto (\Phi_x, \Phi_y, \Phi_\xi, \Phi_\eta) \in T^*\mathcal{M}$ by

$$\Phi_x = \Psi_x, \quad \Phi_y = \varphi + G(\Psi_x, \Psi_\xi, \xi_\varphi), \quad \Phi_\xi = \Psi_\xi, \quad \Phi_\eta = \xi_\varphi.$$

Here $G(x, \xi; \xi_\varphi)$ is some smooth function. For Φ to be a symplectomorphism, G should satisfy

$$\partial_\xi G(\Psi_x, \Psi_\xi, \xi_\varphi) = \partial_{\xi_\varphi} \Psi_x, \quad \partial_x G(\Psi_x, \Psi_\xi, \xi_\varphi) = -\partial_{\xi_\varphi} \Psi_\xi.$$

Since (x, ξ) vary in a disc, this system has a solution if and only if

$$0 = \{\Psi_\xi, \partial_{\xi_\varphi} \Psi_x\} + \{\partial_{\xi_\varphi} \Psi_\xi, \Psi_x\} = \partial_{\xi_\varphi} \{\Psi_\xi, \Psi_x\};$$

this is true since $\{\Psi_\xi, \Psi_x\} = 1$. The defining properties of F_+ now follow from the corresponding properties of the integrable system (ζ, η) ; uniqueness follows from part 3 of Proposition 2.3.8 and the condition $F_+|_{\tilde{K}_+} = 0$.

Now, by part 2 of Proposition 2.3.8 and Proposition 2.4.3, for each $(\tilde{\lambda}_0, \tilde{k}_0) \in \tilde{K} \setminus (\tilde{K}_+ \cup \tilde{K}_-)$, there exists a smooth function $F(\tilde{\lambda}, \tilde{k})$ defined in a neighborhood of $(\tilde{\lambda}_0, \tilde{k}_0)$ such that $\partial_{\tilde{\lambda}} F \neq 0$ and $(F(\mathbf{p}), p_{20})$ has periodicity lattice $2\pi\mathbb{Z}^2$; moreover, part 3 of Proposition 2.3.8 describes all possible F . Then we can cover $\tilde{K} \setminus \tilde{K}_\varepsilon$ by a finite set of the neighborhoods above and modify the resulting functions F and piece them together, to uniquely extend the

function F_+ constructed above from \tilde{K}_ε to $\tilde{K} \setminus \tilde{K}_-$. (Here we use that $\tilde{K} \setminus \tilde{K}_-$ is simply connected.) Similarly, we construct F_- on $\tilde{K} \setminus \tilde{K}_+$. (The fact that F_\pm is smooth at \tilde{K}_\mp will follow from smoothness of F_\mp at \tilde{K}_\mp and the identity $F_- - F_+ = 2\tilde{k}$.)

2. We can verify the formulas for F_\pm for $a = 0$ explicitly, using the fact that the Hamiltonian flow of $\sqrt{\tilde{\lambda}}$ is 2π -periodic in this case. The first two identities now follow immediately. As for the third one, we know by part 3 of Proposition 2.3.8 and the case $a = 0$ that $F_- - F_+ = 2\tilde{k} + c$ for some constant c ; we can then show that $c = 0$ using part 3 of this proposition. Finally, $\partial_{\tilde{\lambda}} F_\pm|_{\tilde{K}_\pm}$ can be computed using Proposition 2.3.10.

3. First, assume that $(\tilde{\lambda}, \tilde{k}) \in \tilde{K}_\varepsilon$ and let Φ be the symplectomorphism constructed in part 1. Then

$$\Phi \circ \gamma_+ = \{\zeta = F_+(\tilde{\lambda}, \tilde{k}), \eta = \tilde{k}, \varphi = \text{const}\}$$

is a circle. Let D_+ be the preimage under Φ of the disc with boundary $\Phi \circ \gamma_+$; then

$$\int_{\gamma_+} \sigma^S = \int_{D_+} \omega^S = \int_{\Phi \circ D_+} \omega_{\mathcal{M}}^S = 2\pi F_+(\tilde{\lambda}, \tilde{k}).$$

We see that (2.4.3) holds for F_+ near \tilde{K}_+ ; similarly, it holds for F_- near \tilde{K}_- . It now suffices to show that for each $(\tilde{\lambda}_0, \tilde{k}_0) \in \tilde{K} \setminus (\tilde{K}_+ \cup \tilde{K}_-)$, there exists a neighborhood $V(\tilde{\lambda}_0, \tilde{k}_0)$ such that if $(\tilde{\lambda}_j, \tilde{k}_j) \in V$, $j = 1, 2$, and γ_j^\pm are some (2π -periodic) Hamiltonian trajectories of $F_\pm(\mathbf{p})$ on $\mathbf{p}^{-1}(\tilde{\lambda}_j, \tilde{k}_j)$, then

$$\int_{\gamma_2^\pm} \sigma^S - \int_{\gamma_1^\pm} \sigma^S = 2\pi(F_\pm(\tilde{\lambda}_2, \tilde{k}_2) - F_\pm(\tilde{\lambda}_1, \tilde{k}_1)). \quad (2.4.4)$$

In particular, if (2.4.3) holds for one point of V , it holds on the whole V . One way to prove (2.4.4) is to use part 1 of Proposition 2.3.9 to conjugate $(F_\pm(\mathbf{p}), p_{20})$ to the system (ξ_x, ξ_y) on the torus $\mathbb{T}_{x,y}$ and note that the left-hand side of (2.4.4) is the integral of the symplectic form over a certain submanifold bounded by γ_1, γ_2 ; therefore, it is the same for the conjugated system, where it can be computed explicitly. \square

Finally, we construct local symplectomorphisms conjugating $(F_\pm(\mathbf{p}), p_{20})$ to (ζ, η) :

Proposition 2.4.5. *For each $(\tilde{\lambda}_0, \tilde{k}_0) \in \tilde{K} \setminus \tilde{K}_\mp$, there exists an exact symplectomorphism Φ_\pm from a neighborhood of $\mathbf{p}^{-1}(\tilde{\lambda}_0, \tilde{k}_0)$ in $T^*\mathbb{S}^2$ onto a neighborhood of*

$$\Lambda_{\mathcal{M}} = \{\zeta = F_\pm(\tilde{\lambda}_0, \tilde{k}_0), \eta = \tilde{k}_0\}$$

in $T^*\mathcal{M}$ such that

$$p_{10} \circ \Phi_\pm^{-1} = F_\pm^{-1}(\zeta, \eta), \quad p_{20} \circ \Phi_\pm^{-1} = \eta.$$

Proof. The existence of Φ_\pm away from \tilde{K}_\pm follows from part 1 of Proposition 2.3.9, applied to the systems $(F_\pm(\mathbf{p}), p_{20})$ and (ζ, η) ; near \tilde{K}_\pm , these symplectomorphisms have been

constructed in the proof of part 1 of Proposition 2.4.4. Exactness follows by part 2 of Proposition 2.3.9 (which still applies in the degenerate case); the equality of classical actions over the flows of $F_{\pm}(\mathbf{p})$ and ζ follows from part 3 of Proposition 2.4.4, while the classical actions over the flows of both p_{20} on $\mathbf{p}^{-1}(\tilde{\lambda}_0, \tilde{k}_0)$ and η on $\Lambda_{\mathcal{M}}$ are both equal to $2\pi\tilde{k}_0$. \square

2.4.3 Moser averaging

Fix $(\tilde{\lambda}_0, \tilde{k}_0) \in \tilde{K} \setminus \tilde{K}_{\mp}$, take small $\varepsilon > 0$, and define (suppressing the dependence on the choice of the sign)

$$\begin{aligned} \Lambda^0 &= \mathbf{p}^{-1}(\tilde{\lambda}_0, \tilde{k}_0), \quad \zeta_0 = F_{\pm}(\tilde{\lambda}_0, \tilde{k}_0), \quad \Lambda_{\mathcal{M}}^0 = \{\zeta = \zeta_0, \eta = \tilde{k}_0\} \subset T^*\mathcal{M}, \\ V^{\varepsilon} &= \{(\tilde{\lambda}, \tilde{k}) \mid |F_{\pm}(\tilde{\lambda}, \tilde{k}) - \zeta_0| \leq \varepsilon, |\tilde{k} - \tilde{k}_0| \leq \varepsilon\} \subset \mathbb{R}^2, \\ V_{\mathcal{M}}^{\varepsilon} &= \{|\zeta - \zeta_0| \leq \varepsilon, |\eta - \tilde{k}_0| \leq \varepsilon\} \subset T^*\mathcal{M}; \end{aligned}$$

then V^{ε} and $V_{\mathcal{M}}^{\varepsilon}$ are compact neighborhoods of $(\tilde{\lambda}_0, \tilde{k}_0)$ and $\Lambda_{\mathcal{M}}^0$, respectively. Here the functions F_{\pm} are as in Proposition 2.4.4. Let Φ_{\pm} be the symplectomorphism constructed in Proposition 2.4.5; we know that for ε small enough, $\Phi_{\pm}(\mathbf{p}^{-1}(V^{\varepsilon})) = V_{\mathcal{M}}^{\varepsilon}$. In this subsection, we prove

Proposition 2.4.6. *For $(\tilde{\lambda}_0, \tilde{k}_0) \in \tilde{K} \setminus \tilde{K}_{\pm}$ and $\varepsilon > 0$ small enough, there exists a pair of operators (B_1, B_2) quantizing Φ_{\pm} near $\mathbf{p}^{-1}(V^{\varepsilon}) \times V_{\mathcal{M}}^{\varepsilon}$ in the sense of Proposition 2.3.5 and operators $Q_1, Q_2 \in \Psi_{\text{cl}}^{\text{comp}}(\mathcal{M})$ such that:*

1. P_1 and P_2 are intertwined with Q_1 and Q_2 , respectively, via (B_1, B_2) , near $\mathbf{p}^{-1}(V^{\varepsilon}) \times V_{\mathcal{M}}^{\varepsilon}$. It follows immediately that the principal symbols of Q_1 and Q_2 are $F_{\pm}^{-1}(\zeta, \eta)$ and η , respectively, near $V_{\mathcal{M}}^{\varepsilon}$.
2. $Q_2 = hD_y$ and the full symbol of Q_1 is a function of (ζ, η) , microlocally near $V_{\mathcal{M}}^{\varepsilon}$. Here we use Weyl quantization on \mathcal{M} , inherited from the covering space \mathbb{R}^2 .

First of all, we use Proposition 2.3.5 to find some (B_1, B_2) quantizing Φ_{\pm} and Q_1, Q_2 intertwined with P_1 and P_2 by (B_1, B_2) . Then we will find a couple of operators $X, Y \in \Psi_{\text{cl}}^{\text{comp}}(\mathcal{M})$ such that $Y = X^{-1}$ near $V_{\mathcal{M}}^{\varepsilon}$ and the operators $Q'_1 = XQ_1Y, Q'_2 = XQ_2Y$ satisfy part 2 of Proposition 2.4.6. This is the content of this subsection and will be done in several conjugations by pseudodifferential operators using Moser averaging technique. We can then change B_1, B_2 following the remark after Proposition 2.3.5 so that P_1 and P_2 are intertwined with Q'_1 and Q'_2 , which finishes the proof.

The averaging construction is based on the following

Proposition 2.4.7. *Assume that the functions $p_0, f_0, g \in C^{\infty}(V_{\mathcal{M}}^{\varepsilon})$ are given by one of the following:*

- (1) $p_0 = f_0 = \eta$ and g is arbitrary;
- (2) $p_0 = \zeta$ and $f_0 = f_0(\zeta, \eta)$ is smooth in $V_{\mathcal{M}}^{\varepsilon}$, with $\partial_{\zeta}f_0 \neq 0$ everywhere, and g is independent of y .

Define

$$\langle g \rangle = \frac{1}{2\pi} \int_0^{2\pi} g \circ \exp(tH_{p_0}) dt.$$

Then there exists unique $b \in C^\infty(V_{\mathcal{M}}^\varepsilon)$ such that $\langle b \rangle = 0$ and

$$g = \langle g \rangle + \{f_0, b\}.$$

Moreover, in case (2) b is independent of y .

Proof. We only consider case (2); case (1) is proven in a similar fashion. First of all, if b is y -independent, then $\{f_0, b\} = \partial_\zeta f_0 \cdot \{\zeta, b\} = \{\zeta, \partial_\zeta f_0 \cdot b\}$; therefore, without loss of generality we may assume that $f_0 = \zeta$. The existence and uniqueness of b now follows immediately if we treat y, η as parameters and consider polar coordinates in the (x, ξ) variables. To show that b is smooth at $\zeta = 0$ (in case $\zeta_0 \leq \varepsilon$), let $z = x + i\xi$ and decompose $g - \langle g \rangle$ into an asymptotic sum of the terms $z^j \bar{z}^k$ with $j, k \geq 0$, $j \neq k$, and coefficients smooth in (y, η) ; the term in b corresponding to $z^j \bar{z}^k$ is $z^j \bar{z}^k / (i(k - j))$. \square

Henceforth in this subsection we will work with the operators Q_j on the level of their full symbols, microlocally in a neighborhood of $V_{\mathcal{M}}^\varepsilon$. (The operators X and Y will then be given by the product of all operators used in conjugations below, multiplied by an appropriate cutoff.) Denote by q_j the full symbol of Q_j . We argue in three steps, following in part [65, §3].

Step 1: Use Moser averaging to make q_2 independent of y .

Assume that q_2 is independent of y modulo $O(h^{n+1})$ for some $n \geq 0$; more precisely,

$$q_2 = \sum_{j=0}^n h^j q_{2,j}(x, \xi, \eta) + h^{n+1} r_n(x, y, \xi, \eta) + O(h^{n+2}).$$

Take some $B \in \Psi_{\text{cl}}^{\text{loc}}$ with principal symbol b and consider the conjugated operator

$$Q'_2 = \exp(ih^n B) Q_2 \exp(-ih^n B).$$

Here $\exp(\pm ih^n B) \in \Psi_{\text{cl}}^{\text{loc}}$ are well-defined by Proposition 2.3.7 and inverse to each other; using the same proposition, we see that the full symbol of Q'_2 is

$$\sum_{j=0}^n h^j q_{2,j}(x, \xi, \eta) + h^{n+1} (r_n - \{\eta, b\}) + O(h^{n+2}).$$

If we choose b as in Proposition 2.4.7(1), then $r_n - \{\eta, b\} = \langle r_n \rangle$ is a function of (x, ξ, η) only; thus, the full symbol of Q'_2 is independent of y modulo $O(h^{n+2})$. Arguing by induction and taking the asymptotic product of the resulting sequence of exponentials, we make the full symbol of Q_2 independent of y .

Step 2: Use our knowledge of the spectrum of P_2 to make $q_2 = \eta$.

First of all, we claim that

$$\exp(2\pi i Q_2/h) = I \tag{2.4.5}$$

microlocally near $V_{\mathcal{M}}^\varepsilon \times V_{\mathcal{M}}^\varepsilon$. For that, we will use Proposition 2.3.6. Let $X \in \Psi_{\text{cl}}^{\text{comp}}(\mathbb{S}^2)$ have real-valued principal symbol, be microlocalized in a small neighborhood of $\mathbf{p}^{-1}(V^\varepsilon)$, but equal to the identity microlocally near this set. Consider

$$\mathcal{P}_t = \exp(itQ_2/h)B_1 \exp(-it(P_2X)/h)B_2.$$

We see that

$$hD_t \mathcal{P}_t = \exp(itQ_2/h)(Q_2B_1 - B_1P_2X) \exp(-it(P_2X)/h)B_2$$

vanishes microlocally near $V_{\mathcal{M}}^\varepsilon \times V_{\mathcal{M}}^\varepsilon$; integrating between 0 and 2π and using part 5 of Proposition 2.3.6 to show that $\exp(-2\pi i(P_2X)/h) = I$ microlocally near $\mathbf{p}^{-1}(V^\varepsilon) \times \mathbf{p}^{-1}(V^\varepsilon)$, we get (2.4.5).

Now, let $X_{\mathcal{M}} \in \Psi_{\text{cl}}^{\text{comp}}(\mathcal{M})$ be equal to the identity microlocally near $\text{WF}_h(Q_2)$; since the full symbol of Q_2 is independent of y , we have $[Q_2, (hD_y)X_{\mathcal{M}}] = O(h^\infty)$. Therefore, by parts 2 and 5 of Proposition 2.3.6

$$\exp(2\pi i(Q_2 - (hD_y)X_{\mathcal{M}})/h) = \exp(-2\pi i D_y X_{\mathcal{M}}) \exp(2\pi i Q_2/h) = I$$

microlocally near $V_{\mathcal{M}}^\varepsilon \times V_{\mathcal{M}}^\varepsilon$. However, $R = h^{-1}(Q_2 - (hD_y)X_{\mathcal{M}}) \in \Psi_{\text{cl}}^{\text{loc}}$ near $V_{\mathcal{M}}^\varepsilon$ and thus the left-hand side $\exp(2\pi i R)$ is pseudodifferential; by part 3 of Proposition 2.3.7, we get $R = l$ for some constant $l \in \mathbb{Z}$ and therefore

$$Q_2 = hD_y + hl$$

microlocally near $V_{\mathcal{M}}^\varepsilon$. It remains to conjugate Q_2 by e^{ily} to get $q_2 = \eta$.

Step 3: Use Moser averaging again to make q_1 a function of (ζ, η) , while preserving $q_2 = \eta$.

Recall that $[P_1, P_2] = 0$; therefore, $[Q_1, Q_2] = 0$ (microlocally near $V_{\mathcal{M}}^\varepsilon$). Since $q_2 = \eta$, this means that q_1 is independent of y . We now repeat the argument of Step 1, using Proposition 2.4.7(2) with $f_0 = F_\pm^{-1}(\zeta, \eta)$. The function b at each step is independent of y ; thus, we can take $[B, hD_y] = O(h^\infty)$. But in that case, conjugation by $\exp(ih^n B)$ does not change Q_2 ; the symbol of the conjugated Q_1 is still independent of y . Finally, $\langle r_n \rangle$ is a function of (ζ, η) ; therefore, q_1 after conjugation will also be a function of (ζ, η) .

2.4.4 Construction of the Grushin problem

In this subsection, we establish a local quantization condition:

Proposition 2.4.8. *1. Assume that $(\tilde{\lambda}_0, \tilde{k}_0) \in \tilde{K} \setminus \tilde{K}_\mp$ and V_ε is the neighborhood of $(\tilde{\lambda}_0, \tilde{k}_0)$ introduced in the beginning of §2.4.3. Then for $\varepsilon > 0$ small enough, there exists a classical symbol $\tilde{G}_\pm(\tilde{\lambda}, \tilde{k}; h)$ on V_ε with principal symbol F_\pm and such that for $k \in \mathbb{Z}$, the poles $\tilde{\lambda} + ih\tilde{\mu}$ of $R_\theta(\omega, \lambda, k)$ with $(\tilde{\lambda}, \tilde{k}) \in V_\varepsilon$ and $|\tilde{\mu}| \leq C_\theta$ are simple with polynomial resolvent estimate*

$L^2 \rightarrow L^2$, in the sense of Definition 2.2.2, and coincide modulo $O(h^\infty)$ with the solution set of the quantization condition

$$\tilde{G}_\pm(\tilde{\lambda} + ih\tilde{\mu}, \tilde{k}; h) \in h\mathbb{N}. \quad (2.4.6)$$

2. Assume that $(\tilde{\lambda}_0, \tilde{k}_0)$ satisfies (2.2.14), but does not lie in \tilde{K} . Then there exists a neighborhood $V(\tilde{\lambda}_0, \tilde{k}_0)$ such that for h small enough, there are no elements $(\tilde{\lambda} + ih\tilde{\mu}, \tilde{k})$ of the joint spectrum of P_1, P_2 with $(\tilde{\lambda}, \tilde{k}) \in V$ and $|\tilde{\mu}| \leq C_\theta$, and $R_\theta(\omega, \lambda, k)$ is bounded $L^2 \rightarrow L^2$ by $O(h^2)$.

To prove part 1, we will use the microlocal conjugation constructed above. Let $(\tilde{\lambda}_0, \tilde{k}_0) \in \tilde{K} \setminus \tilde{K}_\mp$ and $\varepsilon > 0, B_1, B_2, Q_1, Q_2$ be given by Proposition 2.4.6. Consider the operators

$$T_1 = \frac{1}{2}((hD_x)^2 + x^2) - \frac{h}{2}, \quad T_2 = hD_y$$

on \mathcal{M} ; their full symbols are $\zeta - h/2$ and η , respectively. We know that T_1 and T_2 commute; the joint spectrum of T_1, T_2 is $h(\mathbb{N} \times \mathbb{Z})$. Therefore, for any bounded function f on \mathbb{R}^2 , we can define $f(T_1, T_2)$ by means of spectral theory; this is a bounded operator on $L^2(\mathcal{M})$.

Proposition 2.4.9. 1. For $f \in C_0^\infty(\mathbb{R}^2)$, the operator $f(T_1, T_2)$ is pseudodifferential; moreover, $f(T_1, T_2) \in \Psi_{\text{cl}}^{\text{comp}}(\mathcal{M})$ and $\text{WF}_h(f(T_1, T_2)) \subset \{(\zeta, \eta) \in \text{supp } f\}$. The full symbol of $f(T_1, T_2)$ in the Weyl quantization is a function of ζ and η only; the principal symbol is $f(\zeta, \eta)$.

2. Assume that $\zeta_1 \in h\mathbb{N}, \eta_1 \in h\mathbb{Z}$. Let u be the L^2 normalized joint eigenfunction of (T_1, T_2) with eigenvalue (ζ_1, η_1) . Then u is compactly microlocalized and

$$\text{WF}_h(u) \subset \{\zeta = \zeta_1, \eta = \eta_1\}.$$

3. Assume that the function $f(\zeta, \eta; h)$ is Borel measurable, has support contained in a compact h -independent subset K_f of \mathbb{R}^2 , and

$$\max\{|f(\zeta, \eta; h)| \mid \zeta \in h\mathbb{N}, \eta \in h\mathbb{Z}\} \leq Ch^{-r}$$

for some $r \geq 0$. Then the operator $f(T_1, T_2; h)$ is compactly microlocalized, its wavefront set is contained in the square of $\{(\zeta, \eta) \in K_f\}$, and the operator norm of $f(T_1, T_2; h)$ is $O(h^{-r})$.

Proof. For part 1, we can show that the operator $f(T_1, T_2)$ is pseudodifferential by means of Helffer–Sjöstrand formula in calculus of several commuting pseudodifferential operators; see for example [39, Chapter 8]. This also gives information on the principal symbol and the wavefront set of this operator. To show that the full symbol of $f(T_1, T_2)$ depends only on (ζ, η) , note that if $A \in \Psi^{\text{loc}}(\mathcal{M})$ and a is its full symbol in the Weyl quantization, then the full symbol of $[A, T_1]$ in the Weyl quantization is $-ih\{a, \zeta\}$; similarly, the full symbol of $[A, T_2]$ in the Weyl quantization is $-ih\{a, \eta\}$ (see for example [111, discussion before (1.11)]). Since $[f(T_1, T_2), T_j] = 0$, the full symbol of $f(T_1, T_2)$ Poisson commutes with ζ and η .

To show part 2, we take $\chi(\zeta, \eta) \in C_0^\infty(\mathbb{R}^2)$ equal to 1 near (ζ_1, η_1) ; then $u = \chi(T_1, T_2)u$. Similarly, to show part 3, we take χ equal to 1 near K_f ; then the L^2 operator norm of $f(T_1, T_2)$ can be estimated easily and $f(T_1, T_2) = \chi(T_1, T_2)f(T_1, T_2)\chi(T_1, T_2)$. \square

Now, recall that by Proposition 2.4.6, the full symbol of Q_1 in the Weyl quantization is a function of (ζ, η) near $V_{\mathcal{M}}^\varepsilon$; therefore, we can find a compactly supported symbol $\tilde{G}_\pm(\tilde{\lambda}, \tilde{k}; h)$ such that the principal symbol of \tilde{G}_\pm near V^ε is F_\pm and

$$Q_1 = \tilde{G}_\pm^{-1}(T_1, T_2; h)$$

microlocally near $V_{\mathcal{M}}^\varepsilon$, where $\tilde{G}_\pm^{-1}(\zeta, \tilde{k}; h)$ is the inverse of \tilde{G}_\pm in the $\tilde{\lambda}$ variable. Recall also that $Q_2 = T_2$ microlocally near $V_{\mathcal{M}}^\varepsilon$. Multiplying Q_1, Q_2 by an appropriate cutoff, which is a function of T_1, T_2 , we can assume that Q_1, Q_2 are functions of T_1, T_2 modulo $h^\infty \Psi^{-\infty}$. We can now construct a local Grushin problem for Q_1, Q_2 :

Proposition 2.4.10. *Let $(\tilde{\lambda}_1, \tilde{k}_1) \in V^\varepsilon$ and $|\tilde{\mu}_1| \leq C_\theta$.*

1. *Assume that $(\tilde{\lambda}_1 + ih\tilde{\mu}_1, \tilde{k}_1)$ satisfies (2.4.6), with $\zeta_1 = \tilde{G}_\pm(\tilde{\lambda}_1 + ih\tilde{\mu}_1, \tilde{k}_1) \in h\mathbb{N}$. Then there exist operators A_1, A_2, S_1, S_2 such that conditions (L1)–(L5) of Appendix 2.A.2 are satisfied, with $r = 1$, (P_1, P_2) replaced by $(Q_1 - \tilde{\lambda}_1 - ih\tilde{\mu}_1, Q_2 - \tilde{k}_1)$, $K = \{\zeta = \zeta_1, \eta = \tilde{k}_1\}$, and*

$$A_1(Q_1 - \tilde{\lambda}_1 - ih\tilde{\mu}_1) + A_2(Q_2 - \tilde{k}_1) = I - S_1 S_2 \quad (2.4.7)$$

microlocally near $V_{\mathcal{M}}^\varepsilon \times V_{\mathcal{M}}^\varepsilon$.

2. *Fix $\delta > 0$ and assume that*

$$|(\tilde{\lambda}_1 + ih\tilde{\mu}_1, \tilde{k}_1) - (G_\pm^{-1}(\zeta, \eta), \eta)| \geq \delta h, \quad \zeta \in h\mathbb{N}, \quad \eta \in h\mathbb{Z}.$$

Then there exist operators A_1, A_2 such that the conditions (L1)–(L2) of Appendix 2.A.2 are satisfied, with $r = 1$, (P_1, P_2) replaced by $(Q_1 - \tilde{\lambda}_1 - ih\tilde{\mu}_1, Q_2 - \tilde{k}_1)$, $K = \{\zeta = \zeta_1, \eta = \tilde{k}_1\}$, and

$$A_1(Q_1 - \tilde{\lambda}_1 - ih\tilde{\mu}_1) + A_2(Q_2 - \tilde{k}_1) = I$$

microlocally near $V_{\mathcal{M}}^\varepsilon \times V_{\mathcal{M}}^\varepsilon$.

Proof. 1. Let $S_1 : \mathbb{C} \rightarrow L^2(\mathcal{M})$ and $S_2 : L^2(\mathcal{M}) \rightarrow \mathbb{C}$ be the inclusion and the orthogonal projection onto, respectively, the unit joint eigenfunction of (T_1, T_2) with eigenvalue (ζ_1, \tilde{k}_1) . The properties (L3) and (L4) now follow from part 2 of Proposition 2.4.9.

Next, we use a partition of unity on the circle to construct the functions χ_1, χ_2 with the following properties:

- $\chi_j \in C^\infty(\mathbb{R}^2 \setminus 0)$ is positively homogeneous of degree 0;
- $\chi_j \geq 0$ and $\chi_1 + \chi_2 = 1$ everywhere on $\mathbb{R}^2 \setminus 0$;
- $\chi_j(s_1, s_2) = 0$ for $|s_j| < |s_{3-j}|/2$.

It follows that

$$|s_j^{-1} \chi_j(|s_1|^2, |s_2|^2)| \leq C(|s_1| + |s_2|)^{-1}. \quad (2.4.8)$$

Take $\chi(\zeta, \eta) \in C_0^\infty$ supported in a small neighborhood of $V_{\mathcal{M}}^\varepsilon$, while equal to 1 near $V_{\mathcal{M}}^\varepsilon$; define the functions f_1, f_2 as follows:

$$f_1(\zeta, \eta; h) = \frac{\chi(\zeta, \eta)\chi_1(|\tilde{G}_\pm^{-1}(\zeta, \eta; h) - \tilde{\lambda}_1 - ih\tilde{\mu}_1|^2, |\eta - \tilde{k}_1|^2)}{\tilde{G}_\pm^{-1}(\zeta, \eta; h) - \tilde{\lambda}_1 - ih\tilde{\mu}_1},$$

$$f_2(\zeta, \eta; h) = \frac{\chi(\zeta, \eta)\chi_2(|\tilde{G}_\pm^{-1}(\zeta, \eta; h) - \tilde{\lambda}_1 - ih\tilde{\mu}_1|^2, |\eta - \tilde{k}_1|^2)}{\eta - \tilde{k}_1},$$

for $(\zeta, \eta) \neq (\zeta_1, \tilde{k}_1)$; we put $f_j(\zeta_1, \tilde{k}_1) = 0$. We now take $A_j = f_j(T_1, T_2; h)$. Noticing that

$$|\tilde{G}_\pm^{-1}(\zeta, \eta; h) - \tilde{\lambda}_1| + |\eta - \tilde{k}_1| \geq h/C, \quad (\zeta, \eta) \in h(\mathbb{N} \times \mathbb{Z}) \cap \text{supp } \chi \setminus (\zeta_1, \tilde{k}_1),$$

and using Proposition 2.4.9 and (2.4.8), we get that A_j are compactly microlocalized and $\|A_j\| = O(h^{-1})$. Moreover, if $\tilde{\chi}(\zeta, \eta)$ is equal to 1 near (ζ_1, \tilde{k}_1) , then $(1 - \tilde{\chi})f_j$ are smooth symbols; then, $A'_j = (1 - \tilde{\chi})(T_1, T_2)A_j$ belongs to $\Psi_{\text{cl}}^{\text{comp}}$ by part 1 of Proposition 2.4.9 and $A'_j = \tilde{\chi}(T_1, T_2)A_j$ is microlocalized in the Cartesian square of $\{(\zeta, \eta) \in \text{supp } \tilde{\chi}\}$; we have established property (L1), with $r = 1$. The properties (L2), (L5), and (2.4.7) are easy to verify, given that all the operators of interest are functions of T_1, T_2 .

2. This is proved similarly to part 1. \square

Finally, we conjugate the operators of the previous proposition by B_1, B_2 to get a local Grushin problem for P_1, P_2 and obtain information about the joint spectrum:

Proof of Proposition 2.4.8. 1. Assume first that $\tilde{\lambda}_1, \tilde{k}_1, \tilde{\mu}_1$ satisfy the conditions of part 1 of Proposition 2.4.10; let A_1, A_2, S_1, S_2 be the operators constructed there. Recall that A_j are microlocalized in a small neighborhood of $V_{\mathcal{M}}^\varepsilon$. Then the operators

$$\tilde{A}_j = B_2 A_j B_1, \quad \tilde{S}_1 = B_2 S_1, \quad \tilde{S}_2 = S_2 B_1,$$

together with $P_1 - \tilde{\lambda}_1 - ih\tilde{\mu}_1, P_2 - \tilde{k}_1$ in place of P_1, P_2 satisfy the conditions (L1)–(L5) of Appendix 2.A.2 with $K = \mathbf{p}^{-1}(\lambda_1, k_1)$ and

$$\tilde{A}_1(P_1 - \tilde{\lambda}_1 - ih\tilde{\mu}_1) + \tilde{A}_2(P_2 - \tilde{k}_1) = I - \tilde{S}_1 \tilde{S}_2$$

microlocally near $\mathbf{p}^{-1}(V^\varepsilon)$. Moreover, $P_1 - \tilde{\lambda}_1 - ih\tilde{\mu}_1, P_2 - \tilde{k}_1$ satisfy conditions (E1)–(E2) of Appendix 2.A.2 and the set where both their principal symbols vanish is exactly K . We can now apply part 2 of Proposition 2.A.5 to show that for h small enough and some $\delta > 0$, independent of $h, \tilde{\lambda}_1, \tilde{k}_1$, there is exactly one element of the joint spectrum of (P_1, P_2) in the ball of radius δh centered at $(\tilde{\lambda}_1 + ih\tilde{\mu}_1, \tilde{k}_1)$, and this point is within $O(h^\infty)$ of the center of the ball.

Now, we assume that $(\tilde{\lambda} + ih\tilde{\mu}, \tilde{k})$ satisfies the conditions of part 2 of Proposition 2.4.10, with δ specified in the previous paragraph. Then we can argue as above, using part 1 of Proposition 2.A.5, to show that this point does not lie in the joint spectrum for h small enough.

Since every point $(\tilde{\lambda} + ih\tilde{\mu}, \tilde{k})$ such that $(\tilde{\lambda}, \tilde{k}) \in V^\varepsilon$ and $|\tilde{\mu}| \leq C_\theta$ is covered by one of the two cases above, we have established that the angular poles in the indicated region coincide modulo $O(h^\infty)$ with the set of solutions to the quantization condition. Moreover, Proposition 2.A.4 together with the construction of a global Grushin problem from a local one carried out in the proof of Proposition 2.A.5 provides the resolvent estimates required in Definition 2.2.2.

2. The set $\mathbf{p}^{-1}(\tilde{\lambda}_0, \tilde{k}_0)$ is empty by Proposition 2.4.3; therefore, the operator

$$T = (P_1 - \tilde{\lambda} - ih\tilde{\mu})^*(P_1 - \tilde{\lambda} - ih\tilde{\mu}) + (P_2 - \tilde{k})^2$$

is elliptic in the class $\Psi^2(\mathbb{S}^2)$ for $(\tilde{\lambda}, \tilde{k})$ close to $(\tilde{\lambda}_0, \tilde{k}_0)$ and $\tilde{\mu}$ bounded; therefore, for h small enough, $\|T^{-1}\|_{L^2 \rightarrow L^2} = O(1)$. The absence of joint spectrum and resolvent estimate follow immediately if we notice that the restriction of T to \mathcal{D}'_k is $h^4(P_\theta - \lambda)^*(P_\theta - \lambda)$. \square

2.5 Radial problem

2.5.1 Trapping

In §1.5, we use a Regge–Wheeler change of variables $r \rightarrow x$, under which and after an appropriate rescaling the radial operator becomes (using the notation of (2.2.11))

$$\begin{aligned} P_x(h) &= h^2 D_x^2 + V(x, \tilde{\omega}, \tilde{\nu}, \tilde{\lambda}, \tilde{\mu}, \tilde{k}; h), \\ V(x; h) &= (\tilde{\lambda} + ih\tilde{\mu})\Delta_r - (1 + \alpha)^2((r^2 + a^2)(\tilde{\omega} + ih\tilde{\nu}) - a\tilde{k})^2 \end{aligned}$$

(note the difference in notation with §1.8). Let $V(x; h) = V_0(x) + hV_1(x) + h^2V_2(x)$, where

$$V_0(x) = \tilde{\lambda}\Delta_r - (1 + \alpha)^2((r^2 + a^2)\tilde{\omega} - a\tilde{k})^2$$

is the semiclassical principal part of $V(x)$; note that V_0 is real-valued and for $1 \leq \tilde{\omega} \leq 2$ and a small enough, $V_0(\pm\infty) < 0$. Now, Proposition 1.8.4 establishes an arbitrarily large strip free of radial poles in the nontrapping cases; therefore, the only radial poles in the region (2.2.12) appear in case (3) of Proposition 1.8.3. Using the proof of the latter proposition, we may assume that:

- $|\tilde{\lambda} - \tilde{\lambda}_0(\tilde{\omega}, \tilde{k})| < \varepsilon_r$, where $\tilde{\lambda}_0^{-1}$ is the value of the function

$$F_V(r; \tilde{\omega}, \tilde{k}) = \frac{\Delta_r}{(1 + \alpha)^2((r^2 + a^2)\tilde{\omega} - a\tilde{k})^2}$$

at its only maximum point. Under the assumptions (2.2.12), $1/C \leq \tilde{\lambda}_0 \leq C$ for some constant C ;

- V_0 , as a function of x , has unique global maximum x_0 , $|V_0(x_0)| < \varepsilon_r^3$ and $V_0''(x) < 0$ for $|x - x_0| \leq \varepsilon_r$;

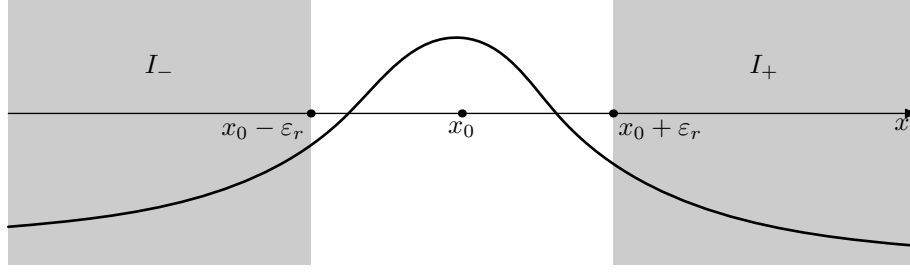
Figure 2.3: The potential V_0 and the intervals I_{\pm} .

- $V_0(x) < -\varepsilon_r^3$ for $|x - x_0| \geq \varepsilon_r$.

Here $\varepsilon_r > 0$ is a small constant we will choose later. We can also compute

$$\begin{aligned} \tilde{\lambda}_0 &= \frac{27M^2\tilde{\omega}^2}{1 - 9\Lambda M^2} \text{ for } a = 0; \\ V_0''(x_0) &= -18M^4(1 - 9\Lambda M^2)^2\tilde{\lambda} \text{ for } a = 0, \quad \tilde{\lambda} = \tilde{\lambda}_0. \end{aligned} \quad (2.5.1)$$

Letting

$$p_0(x, \xi) = \xi^2 + V_0(x)$$

be the principal symbol of P_x , we see that p_0 has a nondegenerate hyperbolic critical point at $(x_0, 0)$ and this is the only critical point in the set $\{p_0 \geq -\varepsilon_r^3\}$.

2.5.2 WKB solutions and the outgoing condition

Firstly, we obtain certain approximate solutions to the equation $P_x u = 0$ in the region $|x - x_0| > \varepsilon_r$, where V_0 is known to be negative. (Compare with [100, Sections 2 and 3].) Define the intervals

$$I_+ = (x_0 + \varepsilon_r, +\infty), \quad I_- = (-\infty, x_0 - \varepsilon_r), \quad I_0 = (x_0 - 2\varepsilon_r, x_0 + 2\varepsilon_r). \quad (2.5.2)$$

Let $\psi_0(x)$ be a smooth function on $I_+ \cup I_-$ solving the eikonal equation

$$\psi_0'(x) = \operatorname{sgn}(x - x_0) \sqrt{-V_0(x)}.$$

(We will specify a normalization condition for ψ_0 later.) Then we can construct approximate WKB solutions

$$u_{\pm}^{\pm}(x; h) = e^{i\psi_0(x)/h} a_{\pm}^{\pm}(x; h), \quad u_{\pm}^{-}(x; h) = e^{-i\psi_0(x)/h} a_{\pm}^{-}(x; h), \quad x \in I_{\pm}, \quad (2.5.3)$$

such that $P_x u_{\pm}^{\delta} = O(h^{\infty})$ in $C^{\infty}(I_{\pm})^8$ and a_{γ}^{δ} are smooth classical symbols in h , for $\gamma, \delta \in \{+, -\}$. Indeed, if

$$a_{\gamma}^{\delta}(x; h) \sim \sum_{j \geq 0} h^j a_{\gamma}^{\delta(j)}(x),$$

then the functions $a_{\gamma}^{\delta(j)}$ have to solve the transport equations

$$\begin{aligned} (2\psi_0'(x)\partial_x + \psi_0''(x) \pm iV_1(x))a_{\gamma}^{\pm(0)} &= 0, \\ (2\psi_0'(x)\partial_x + \psi_0''(x) \pm iV_1(x))a_{\gamma}^{\pm(j+1)} &= \pm i(\partial_x^2 - V_2(x))a_{\gamma}^{\pm(j)}, \quad j \geq 0; \end{aligned} \quad (2.5.4)$$

the latter can be solved inductively in j . We will fix the normalization of $a_{\gamma}^{\delta(0)}$ later; right now, we only require that for x in a compact set, $a_{\gamma}^{\delta(0)} \sim 1$ in the sense that $C^{-1} \leq |a_{\gamma}^{\delta(0)}| \leq C$ for some h -independent constant C . Put

$$\Gamma_{\gamma}^{\pm} = \{(x, \pm\psi_0'(x)) \mid x \in I_{\gamma}\} \subset T^*I_{\gamma}, \quad \gamma \in \{+, -\}; \quad (2.5.5)$$

then by Proposition 2.3.1 (with $m = 0$),

$$\text{WF}_h(u_{\gamma}^{\delta}) \subset \Gamma_{\gamma}^{\delta}, \quad \gamma, \delta \in \{+, -\}. \quad (2.5.6)$$

Now, we show that the Cauchy problem for the equation $P_x u = 0$ is well-posed semiclassically in I_{\pm} . For two smooth functions v_1, v_2 on some interval, define their semiclassical Wronskian by

$$W(v_1, v_2) = v_1 \cdot h\partial_x v_2 - v_2 \cdot h\partial_x v_1;$$

then

$$h\partial_x W(v_1, v_2) = v_2 \cdot P_x v_1 - v_1 \cdot P_x v_2. \quad (2.5.7)$$

Also, if $W(v_1, v_2) \neq 0$ and u is some smooth function, then

$$u = \frac{W(u, v_1)v_2 - W(u, v_2)v_1}{W(v_2, v_1)}. \quad (2.5.8)$$

We have $W(u_{\pm}^+, u_{\pm}^-) \sim 1$; therefore, the following fact applies:

Proposition 2.5.1. *Assume that $I \subset \mathbb{R}$ is an interval and $U \subset I$ is a nonempty open set. Let $v_1(x; h), v_2(x; h) \in C^{\infty}(I)$ be two polynomially bounded functions such that $P_x v_j(x; h) = O(h^{\infty})$ in $C^{\infty}(I)$ and $W(v_1, v_2)^{-1}$ is polynomially bounded. (Note that by (2.5.7), $d_x W(v_1, v_2)$ is $O(h^{\infty})$.) Let $u(x; h) \in C^{\infty}(I)$ be polynomially bounded in $C^{\infty}(U)$ and $P_x u = O(h^{\infty})$ in $C^{\infty}(I)$. Then $u = c_1 v_1 + c_2 v_2 + O(h^{\infty})$ in $C^{\infty}(I)$, where the constants c_1, c_2 are polynomially bounded. Moreover, $c_j = W(u, v_{3-j})/W(v_j, v_{3-j}) + O(h^{\infty})$.*

⁸Henceforth we say that $u = O(h^{\infty})$ in $C^{\infty}(I)$ for some open set I , if for every compact $K \subset I$ and every N , $\|u\|_{C^N(K)} = O(h^N)$. In particular, this does not provide any information on the growth of u at the ends of I . Similarly, we say that u is polynomially bounded in $C^{\infty}(I)$ if for every K and N , there exists M such that $\|u\|_{C^N(K)} = O(h^{-M})$.

Proof. Let $W_j = W(u, v_j)$. Combining (2.5.7) and (2.5.8), we get $|d_x W_j| = O(h^\infty)(|W_1| + |W_2|)$. Also, W_j are polynomially bounded on U . By Gronwall's inequality, we see that W_j are polynomially bounded on I and constant modulo $O(h^\infty)$; it remains to use (2.5.8). \square

Now, recall §1.5 that for X_0 large enough, we have $V(x) = V_\pm(e^{\mp A_\pm x})$ for $\pm x > X_0$, where $A_\pm > 0$ are some constants and $V_\pm(w)$ are holomorphic functions in the discs $\{|w| < e^{-A_\pm X_0}\}$, and $V_\pm(0) = -\omega_\pm^2$, where

$$\omega_\pm = (1 + \alpha)((r_\pm^2 + a^2)(\tilde{\omega} + ih\tilde{\nu}) - a\tilde{k}). \quad (2.5.9)$$

For a and h small enough, we have $\operatorname{Re} \omega_\pm > 0$. In §1.5, we constructed exact solutions $u_\pm(x)$ to the equation $P_x u_\pm = 0$ such that

$$u_\pm(x) = e^{\pm i\omega_\pm x/h} v_\pm(e^{\mp A_\pm x}) \text{ for } \pm x > X_0,$$

with $v_\pm(w)$ holomorphic in the discs $\{|w| < e^{-A_\pm X_0}\}$ and $v_\pm(0) = 1$. Note that we can use a different normalization condition than Proposition 1.5.2, as $\operatorname{Im} \omega_\pm = O(h)$ under the assumptions (2.2.12).

Proposition 2.5.2. *For a certain normalization of the functions ψ_0 and $a_\pm^{+(0)}$,*

$$u_\pm(x) = u_\pm^\pm(x) + O(h^\infty) \text{ in } C^\infty(I_\pm). \quad (2.5.10)$$

In particular, by (2.5.6)

$$\operatorname{WF}_h(u_\pm|_{I_\pm}) \subset \Gamma_\pm^+. \quad (2.5.11)$$

Proof. We will consider the case of u_+ . By Proposition 2.5.1, it is enough to show (2.5.10) for $\pm x > X_0$, where X_0 is large, but fixed. We choose X_0 large enough so that $\operatorname{Re} V_\pm(w) < 0$ for $|w| \leq e^{-A_\pm X_0}$. Then there exists a function $\psi(x)$ such that

$$\begin{aligned} (\partial_x \psi(x))^2 + V(x) &= 0, \quad x > X_0; \\ \psi(x) &= \omega_+ x + \tilde{\psi}(e^{-A_+ x}), \end{aligned}$$

with $\tilde{\psi}$ holomorphic in $\{|w| < e^{-A_+ X_0}\}$. We can fix ψ by requiring that $\tilde{\psi}(0) = 0$. Take

$$u_+(x) = e^{i\psi(x)/h} a(e^{-A_+ x}; h);$$

then $P_x u_+ = 0$ if and only if

$$([hA_+ w D_w + A_+ w \tilde{\psi}'(w) - \omega_+]^2 + V)a = 0.$$

This can be rewritten as

$$-A_+(w \tilde{\psi}'(w))' a + (2\omega_+ + ihA_+ - 2A_+ w \tilde{\psi}'(w)) \partial_w a + ihA_+ w \partial_w^2 a = 0.$$

We will solve this equation by a power series in w and estimate the terms of this series uniformly in h . Let us write

$$\tilde{\psi}'(w; h) = \sum_{l \geq 0} \psi_l(h) w^l, \quad a(w; h) = \sum_{j \geq 0} a_j(h) w^j$$

and solve for a_j with the initial condition $a_0 = 1$, obtaining

$$a_{j+1}(h) = \frac{A_+}{(j+1)(2\omega_+ + ihA_+(j+1))} \sum_{0 \leq l \leq j} \psi_l(h)(1+2j-l)a_{j-l}(h).$$

We claim that for some R , all j , and small h , $|a_j(h)| \leq R^j$. Indeed, we have $|2\omega_+ + ihA_+(j+1)| \geq \varepsilon > 0$; combining this with an estimate on ψ_l , we get

$$|a_{j+1}| \leq \frac{C}{j+1} \sum_{0 \leq l \leq j} S^l (1+2j-l) |a_{j-l}| \leq 2C \sum_{0 \leq l \leq j} S^l |a_{j-l}|$$

for some constants C and S . We can then conclude by induction if $R \geq 2C + S$. In a similar way, we can estimate the derivatives of a_j in h ; therefore, $a(w; h)$ is a classical symbol for $|w| < R^{-1}$.

Now, we take X_0 large enough so that $e^{-A_+X_0} < R^{-1}$ and restrict ourselves to real $x > X_0$. We can normalize ψ_0 so that $\psi(x) = \psi_0(x) + h\psi_1(x; h)$ for some classical symbol ψ_1 ; then

$$u_+(x) = e^{i\psi_0(x)/h} [e^{i\psi_1(x; h)} a(e^{-A_+x}; h)].$$

The expression in square brackets is a classical symbol; therefore, this expression solves the transport equations (2.5.4); it is then equal to a constant times a_+^+ , modulo $O(h^\infty)$ errors. \square

2.5.3 Transmission through the barrier

First of all, we establish a microlocal normal form for P_x near the potential maximum. Let $\varepsilon_0 > 0$ be small; define

$$K_0 = \{|x - x_0| \leq \varepsilon_0, |\xi| \leq \varepsilon_0\} \subset T^*\mathbb{R}.$$

We pick ε_r small enough, depending on ε_0 , such that $\varepsilon_r < \varepsilon_0/2$ and

$$\{p_0 = 0\} \subset K_0 \cup \bigcup_{\gamma, \delta} \Gamma_\gamma^\delta,$$

with Γ_γ^δ defined in (2.5.5). (Recall from §2.5.1 that ε_r controls how close we are to the trapping region.) We also assume that ε_0 is small enough so that $(x_0, 0)$ is the only critical point of p_0 in K_0 .

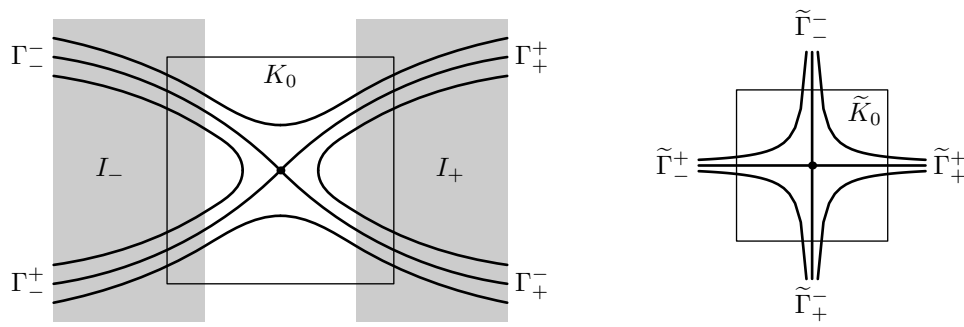
 Figure 2.4: Level lines of p_0 before and after conjugation by Φ .

Proposition 2.5.3. *For ε_0 small enough and ε_r small enough depending on ε_0 , there exists a symplectomorphism Φ from a neighborhood of K_0 onto a neighborhood of the origin in $T^*\mathbb{R}$ and operators B_1, B_2 quantizing Φ near $K_0 \times \Phi(K_0)$ in the sense of Proposition 2.3.5, such that P_x is intertwined via (B_1, B_2) with the operator $SQ(\beta)$ microlocally near $K_0 \times \Phi(K_0)$, with $S \in \Psi_{\text{cl}}^0$ elliptic in the class $\Psi^0(\mathbb{R})$,*

$$Q(\beta) = hx D_x - \beta,$$

and $\beta = \beta(\tilde{\omega}, \tilde{\nu}, \tilde{\lambda}, \tilde{\mu}, \tilde{k}; h)$ a classical symbol. Moreover, the principal part β_0 of β is real-valued, independent of $\tilde{\nu}, \tilde{\mu}$, and vanishes if and only if $\tilde{\lambda} = \tilde{\lambda}_0(\tilde{\omega}, \tilde{k})$. Also,

$$\beta_0 = -\frac{V_0(x_0)}{\sqrt{-2V_0''(x_0)}} + O(V_0(x_0)^2), \quad (2.5.12)$$

$$\beta_0 = \frac{27M^2\tilde{\omega}^2 - \tilde{\lambda}(1 - 9\Lambda M^2)}{2\sqrt{\tilde{\lambda}}(1 - 9\Lambda M^2)} + O(V_0(x_0)^2) \text{ for } a = 0. \quad (2.5.13)$$

Finally, $\Phi(K_0) \supset \tilde{K}_0 = \{|x| \leq \tilde{\varepsilon}_0, |\xi| \leq \tilde{\varepsilon}_0\}$ for some $\tilde{\varepsilon}_0$ depending on ε_0 , and, with I_0 defined in (2.5.2),

$$\Phi(\Gamma_{\pm}^+) \subset \tilde{\Gamma}_{\pm}^+ = \{\pm x > 0, \xi = \beta_0/x, |\xi| \leq \tilde{\varepsilon}_0/2\}, \quad (2.5.14)$$

$$\Phi(\Gamma_{\pm}^-) \subset \tilde{\Gamma}_{\pm}^- = \{\mp \xi > 0, x = \beta_0/\xi, |x| \leq \tilde{\varepsilon}_0/2\}; \quad (2.5.15)$$

$$\{p_0 = 0\} \cap \{x \in I_0\} \subset \Phi^{-1}(\tilde{K}_0) \subset K_0. \quad (2.5.16)$$

Proof. First of all, we use [27, Theorem 12] to construct Φ, B_1, B_2 conjugating P_x microlocally near the critical point $(x_0, 0)$ to an operator of the form $f[hxD_x]$, for some symbol $f(s; h)$, where the latter employs the formal functional calculus of §2.3.2. The techniques in the proof are similar to those of §2.4.3 of the present chapter, with appropriate replacements for Propositions 2.3.10 and 2.4.7; therefore, the proof goes through for complex valued symbols with real principal part.

Let f_0 be the principal part of f ; then $p_0 \circ \Phi^{-1} = f_0(x\xi)$. Note that $\Phi(x_0, 0) = (0, 0)$. The level set $\{p_0 = V_0(x_0)\}$ at the trapped energy contains in particular the outgoing trajectory $\{x > x_0, \xi = \sqrt{V_0(x_0) - V_0(x)}\}$; we can choose Φ mapping this trajectory into $\{x > 0, \xi = 0\}$. Since the latter is also outgoing for the Hamiltonian flow of $x\xi$, we have $\partial_s f_0(0) > 0$; it follows that $\partial_s f_0(s) > 0$ for all s (if $\partial_s f_0$ vanishes, then p_0 has a critical point other than $(x_0, 0)$). The function $f(s; h)$ not uniquely defined; however, its Taylor decomposition at $s = 0, h = 0$ is and we can compute in particular

$$f_0(s) = V_0(x_0) + s\sqrt{-2V_0''(x_0)} + O(s^2). \quad (2.5.17)$$

Therefore, for ε_r small enough, we can solve the equation $f(s; h) = 0$ for s ; let β be the solution. We now write $f(s; h) = f_1(s; h)(s - \beta)$ for some nonvanishing f_1 and get $f[hxD_x] = SQ(\beta)$ microlocally in $\Phi(K_0)$, with $S = f_1[hxD_x]$ in $\Phi(K_0)$ and extended to be globally elliptic outside of this set. The equation (2.5.12) follows from (2.5.17), while (2.5.13) follows from (2.5.12) and (2.5.1).

Finally, $p_0 = 0$ on each Γ_γ^δ and thus $x\xi = \beta$ on $\Phi(\Gamma_\gamma^\delta)$. By analysing the properties of Φ near $(x_0, 0)$, we can deduce which part of the sets $\{x\xi = \beta\}$ each Γ_γ^δ maps into; (2.5.14)–(2.5.16) follow for ε_r small enough. \square

We now describe the radial quantization condition and provide a non-rigorous explanation for it. Recall from §1.5 that (ω, λ, k) is a pole of R_r if and only if the functions u_\pm , studied in the previous subsection, are multiples of each other. Assume that this is true and $u = u_+ \sim u_-$. However, by (2.5.11) the function B_1u is microlocalized on the union of $\tilde{\Gamma}_\pm^+$, but away from $\tilde{\Gamma}_\pm^-$; it also solves $Q(\beta)B_1u = 0$ microlocally. By propagation of singularities, this can happen only if the characteristic set of $Q(\beta)$ is $\{x\xi = 0\}$, and in this case, B_1u is smooth near $x = 0$. Then B_1u must be given by $x^{i\beta/h}$, with $\beta \in -ih\mathbb{N}$ and \mathbb{N} denoting the set of nonnegative integers. Therefore, we define the radial quantization symbol $\mathcal{F}^r(m, \tilde{\omega}, \tilde{\nu}, \tilde{k}; h)$ as the solution $\tilde{\lambda} + ih\tilde{\mu}$ to the equation

$$\beta(\tilde{\omega}, \tilde{\nu}, \tilde{\lambda}, \tilde{\mu}, \tilde{k}; h) = -ihm, \quad m \in \mathbb{Z}, \quad 0 \leq m \leq C_m.$$

The expansions for \mathcal{F}^r near $a = 0$ described in Proposition 2.2.6 follow from (2.5.13) and (2.B.12).

We now prove the rest of Proposition 2.2.6. We start with quantifying the statement that in order for the equation $Q(\beta)u = 0$ to have a nontrivial solution smooth near $x = 0$, the quantization condition must be satisfied:

Proposition 2.5.4. *Assume that $\beta \in \mathbb{C}$ satisfies*

$$|\beta| \leq C_\beta, \quad |\operatorname{Im} \beta| \leq C_\beta h, \quad \min_{m \in \mathbb{N}} |\beta + ihm| \geq C_\beta^{-1} h, \quad (2.5.18)$$

for some constant C_β . Let $U \subset \mathbb{R}$ be a bounded open interval, $I \subset U$ be a compact interval centered at zero, and $X \in \Psi_{\text{cl}}^{\text{comp}}(\mathbb{R})$. Then there exist constants C and N such that for each $u \in L^2(\mathbb{R})$,

$$\|Xu\|_{L^2(I)} \leq Ch^{-N} \|Q(\beta)Xu\|_{L^2(U)} + O(h^\infty) \|u\|_{L^2(\mathbb{R})}. \quad (2.5.19)$$

Proof. First, assume that $\text{Im } \beta \geq h$. Let I' be an interval compactly contained in I and centered at zero. We will use the fact that every $C^\infty(I')$ seminorm of Xu is bounded by $Ch^{-N}\|Xu\|_{L^2(I)} + O(h^\infty)\|u\|_{L^2(\mathbb{R})}$ for some constants C and N , depending on the seminorm chosen. (Henceforth C and N will be constants whose actual values may depend on the context.) Since $Xu \in C^\infty$, we can write

$$hD_x(x^{-i\beta/h}Xu) = x^{-1-i\beta/h}Q(\beta)Xu.$$

However, $\text{Re}(-i\beta/h) \geq 1$; therefore, $x^{-i\beta/h}Xu$ vanishes at $x = 0$ and we can integrate to get

$$\|x^{-i\beta/h}Xu\|_{L^\infty(I)} \leq C\|Q(\beta)Xu\|_{L^2(I)}. \quad (2.5.20)$$

On the other hand,

$$\|Xu\|_{L^\infty(I')} \leq Ch^{-N_0}\|Xu\|_{L^2(I)} + O(h^\infty)\|u\|_{L^2(\mathbb{R})}. \quad (2.5.21)$$

for some constants C and N_0 . Now, take a large constant \varkappa ; using (2.5.21) in $\{|x| < h^\varkappa\}$ and (2.5.20) elsewhere, we get

$$\|Xu\|_{L^2(I)} \leq Ch^{\varkappa/2-N_0}\|Xu\|_{L^2(I)} + h^{-\varkappa C\beta}\|Q(\beta)Xu\|_{L^2(I)} + O(h^\infty)\|u\|_{L^2(\mathbb{R})};$$

taking \varkappa large enough, we get (2.5.19).

For the general case, we choose an integer M large enough so that $\text{Im}(\beta + ihM) \geq h$. Let v be M -th Taylor polynomial of Xu at zero. Since

$$\|Q(\beta + ihM)D_x^M Xu\|_{L^2(I)} = \|D_x^M Q(\beta)Xu\|_{L^2(I)} \leq Ch^{-N}\|Q(\beta)Xu\|_{L^2(U)} + O(h^\infty)\|u\|_{L^2(\mathbb{R})},$$

we apply the current proposition for the case $\text{Im } \beta \geq h$ considered above to get

$$\|Xu - v\|_{L^2(I)} \leq C\|D_x^M Xu\|_{L^2(I)} \leq Ch^{-N}\|Q(\beta)Xu\|_{L^2(U)} + O(h^\infty)\|u\|_{L^2(\mathbb{R})};$$

therefore, $\|Q(\beta)v\|_{L^2(I)}$ is bounded by the same expression. However, one can verify directly that if β is $C_\beta^{-1}h$ away from $-ih\mathbb{N}$, then

$$\|v\|_{L^2(I)} \leq Ch^{-N}\|Q(\beta)v\|_{L^2(I)};$$

this completes the proof. \square

Now, we show that each radial pole lies within $o(h)$ of a pseudopole:

Proposition 2.5.5. *Assume that $\beta(h)$ satisfies (2.5.18). Then for h small enough, (ω, λ, k) is not a radial pole, and for each compact interval $I \subset \mathbb{R}$, there exist constants C and N such that*

$$\|1_I R_r(\omega, \lambda, k) 1_I\|_{L^2 \rightarrow L^2} \leq Ch^{-N}.$$

Proof. Let $u \in H_{\text{loc}}^2(\mathbb{R})$ be an outgoing solution to the equation $P_x u = f$, with $f \in L^2$ supported in a fixed compact subset inside the open interval I . Then

$$u(x) = c_{\pm} u_{\pm}(x), \quad \pm x \gg 0,$$

for some constants c_{\pm} . Clearly, $|c_{\pm}| \leq C \|u\|_{L^2(I)}$. Using the method of proof of Proposition 2.5.1, we get

$$\|u - c_{\pm} u_{\pm}\|_{L^2(I \cap I_{\pm})} \leq Ch^{-1} \|f\|_{L^2}. \quad (2.5.22)$$

Next, let $\chi \in C_0^\infty(I_0)$ be equal to 1 near the complement of $I_+ \cup I_-$ and B_1 be the operator introduced in Proposition 2.5.3; consider the compactly microlocalized operator

$$T = SQ(\beta)B_1 - B_1P_x.$$

Then by Proposition 2.3.5, we can write $T = TX + O(h^\infty)$, where $X \in \Psi_{\text{cl}}^{\text{comp}}$ is a certain operator vanishing microlocally on K_0 . By (2.5.16), we can further write $X = X_1 + X_2$, where $X_j \in \Psi_{\text{cl}}^{\text{comp}}$, $\text{WF}_h(X_j) \cap K_0 = \emptyset$, $\text{WF}_h(X_1) \cap \{p_0 = 0\} = \emptyset$ and $\text{WF}_h(X_2) \subset \{x \in I_+ \cup I_-\}$. By ellipticity,

$$\|X_1 u\|_{L^2} \leq C \|f\|_{L^2} + O(h^\infty) \|u\|_{L^2(I)}.$$

Take $\chi_{\pm} \in C_0^\infty(I_{\pm})$ such that $\chi_{\pm} = 1$ near $I_{\pm} \cap \pi(\text{WF}_h(X_2))$ (here $\pi : \mathbb{T}^*\mathbb{R} \rightarrow \mathbb{R}$ is the projection map onto the base variable and $\pi(\text{WF}_h(X_2))$ is a compact subset of $I_+ \cup I_-$); then by (2.5.22),

$$\begin{aligned} \|X_2(u - u_1)\|_{L^2} &\leq Ch^{-1} \|f\|_{L^2} + O(h^\infty) \|u\|_{L^2(I)}, \\ u_1 &= c_+ \chi_+(x) u_+ + c_- \chi_-(x) u_-. \end{aligned}$$

It follows that

$$\|SQ(\beta)B_1 u - TX_2 u_1\|_{L^2} \leq Ch^{-1} \|f\|_{L^2} + O(h^\infty) \|u\|_{L^2(I)}.$$

Combining (2.5.11) with (2.5.14) and the fact that $\text{WF}_h(X_2) \cap K_0 = \emptyset$, we get

$$\text{WF}_h(TX_2 \chi_{\pm}(x) u_{\pm}) \subset \tilde{\Gamma}_{\pm}^+ \setminus \tilde{K}_0.$$

The projections of the latter sets onto the x variable do not intersect $\tilde{I}_0 = \{|x| \leq \tilde{\varepsilon}_0\}$; therefore, for some open \tilde{U}_0 containing \tilde{I}_0 ,

$$\|TX_2 u_1\|_{L^2(\tilde{U}_0)} = O(h^\infty) \|u\|_{L^2(I)}.$$

Using ellipticity of S , we then get

$$\|Q(\beta)B_1 u\|_{L^2(\tilde{U}_0)} \leq Ch^{-1} \|f\|_{L^2} + O(h^\infty) \|u\|_{L^2(I)}.$$

Applying Proposition 2.5.4 to $B_1 u$ on I_0 and using that B_1 is compactly microlocalized, we get

$$\|\tilde{X} B_1 u\|_{L^2} \leq Ch^{-N} \|f\|_{L^2} + O(h^\infty) \|u\|_{L^2(I)},$$

for any $\tilde{X} \in \Psi_{\text{cl}}^{\text{comp}}$ microlocalized in \tilde{K}_0 . Using the elliptic estimate and (2.5.16), we get

$$\|u\|_{L^2(I_0)} \leq Ch^{-N}\|f\|_{L^2} + O(h^\infty)\|u\|_{L^2(I)}.$$

From here by (2.5.22),

$$|c_\pm| \leq C\|c_\pm u_\pm\|_{L^2(I_\pm \cap I_0)} \leq Ch^{-N}\|f\|_{L^2} + O(h^\infty)\|u\|_{L^2(I)};$$

combining the last two estimates with (2.5.22), we get the required estimate:

$$\|u\|_{L^2(I)} \leq Ch^{-N}\|f\|_{L^2} + O(h^\infty)\|u\|_{L^2(I)}. \quad \square$$

To finish the proof of Proposition 2.2.6, it remains to show

Proposition 2.5.6. *Fix $\tilde{\omega}, \tilde{\nu}, \tilde{k}$ satisfying (2.2.12), $m \in \mathbb{N}$ bounded by a large constant C_m , and let V be the set of all λ such that*

$$|\beta(\tilde{\omega}, \tilde{\nu}, \tilde{k}, \tilde{\lambda}, \tilde{\mu}; h) + ihm| < h/3.$$

Then for h small enough, $R_r(\omega, \lambda, k)$ has a unique pole λ_0 in V , and λ_0 is within $O(h^\infty)$ of $\mathcal{F}^r(m, \tilde{\omega}, \tilde{\nu}, \tilde{k}; h)$. Moreover, we can write

$$R_r(\omega, \lambda, k) = \frac{S(\lambda)}{\lambda - \lambda_0}, \quad \lambda \in V,$$

where the family of operators $S(\lambda) : L_{\text{comp}}^2(\mathbb{R}) \rightarrow L_{\text{loc}}^2(\mathbb{R})$ is bounded polynomially in h and $S(\lambda_0)$ is a rank one operator.

Proof. We will use Proposition 2.5.3 and the fact that $\beta = O(h)$ to extend the WKB solutions u_\pm^\pm from I_\pm to the whole \mathbb{R} . Consider the locally integrable functions

$$\tilde{u}_\pm^\pm = (x \pm i0)^{i\beta/h}.$$

solving the equation $Q(\beta)\tilde{u}_\pm^\pm = 0$. (See for example [70, §3.2] for the definition and basic properties of $(x \pm i0)^b$.) We have

$$\text{WF}_h(\tilde{u}_\pm^\pm) \subset \{\xi = 0\} \cup \{x = 0, \pm\xi > 0\};$$

$\tilde{u}_\pm^\pm(x) = x^{i\beta/h}$ microlocally near $\{x > 0, \xi = 0\}$, $\tilde{u}_\pm^\pm(x) = e^{\mp\pi\beta/h}(-x)^{i\beta/h}$ microlocally near $\{x < 0, \xi = 0\}$. Using the formulas for the Fourier transform of \tilde{u}_\pm^\pm [70, Example 7.1.17], we get

$$\tilde{u}_\pm^\pm(x) = \frac{h^{i\beta/h} e^{\mp\beta\pi/(2h)}}{\Gamma(-i\beta/h)} \int_0^\infty \chi(\xi) \xi^{-1-i\beta/h} e^{\pm ix\xi/h} d\xi$$

microlocally near $\{x = 0, \pm\xi \in K_\xi\}$, for every $\chi \in C_0^\infty(0, \infty)$ such that $\chi = 1$ near $K_\xi \subset (0, \infty)$. Let B_2 be the operator constructed in Proposition 2.5.3. By (2.5.16) $P_x B_2 \tilde{u}_\pm^\pm = O(h^\infty)$ in $C^\infty(I_0)$, and $B_2 \tilde{u}_\pm^\pm = \tilde{c}_\pm u_\pm^\pm + O(h^\infty)$ in $C^\infty(I_\pm \cap I_0)$ for some constants $\tilde{c}_\pm \sim 1$.

To prove the latter, we can use the theory of Fourier integral operators and Lagrangian distributions to represent $B_2\tilde{u}_\pm^\pm$ in the form (2.5.3) microlocally near Γ_\pm^\pm ; the symbols in these WKB expressions will have to solve the transport equations. Then we can use $B_2\tilde{u}_\pm^\pm$ to extend u_\pm^\pm to $I_\pm \cup I_0$ so that $P_x u_\pm^\pm = O(h^\infty)$ there. We claim that

$$u_\pm^\pm = c_{\pm 1}u_\mp^\pm + c_{\pm 2}\Gamma(-i\beta/h)^{-1}u_\mp^\pm + O(h^\infty) \quad (2.5.23)$$

in $C^\infty(I_\mp \cap I_0)$, with $c_{\pm j}$ constants such that $c_{\pm j}$ and $c_{\pm j}^{-1}$ are polynomially bounded in h . To show (2.5.23), we can apply the theory of Lagrangian distributions to $B_2\tilde{u}_\pm^\pm$ one more time; alternatively, we know that this function is an $O(h^\infty)$ approximate solution to the equation $P_x u = 0$ on $I_0 \cap I_\mp$, and we have control on its L^2 norm when microlocalized to Γ_\mp^+ and Γ_\mp^- . Thus, we can extend u_\pm^\pm to the whole \mathbb{R} as a polynomially bounded family with $P_x u_\pm^\pm = O(h^\infty)$ in $C^\infty(\mathbb{R})$ and (2.5.23) holding on I_\mp . Similarly we can extend u_\mp^\pm ; using either of the families (u_\pm^\pm, u_\mp^\pm) in Proposition 2.5.1 together with Proposition 2.5.2, we get $u_\pm = u_\pm^\pm + O(h^\infty)$ in $C^\infty(\mathbb{R})$. It now follows from (2.5.23) that

$$W(u_+, u_-) = c(\Gamma(-i\beta/h)^{-1} + O(h^\infty)),$$

with c and c^{-1} bounded polynomially in h . By (1.5.8), we get

$$R_r(\omega, \lambda, k) = \frac{\tilde{S}(\omega, \lambda, k)}{W(u_+, u_-)},$$

with the family \tilde{S} holomorphic and bounded polynomially in h . Moreover, for $W(u_+, u_-) = 0$, \tilde{S} is proportional to $u_+ \otimes u_+$ and thus has rank one. We are now done if we let λ_0 be the unique solution to the equation $W(u_+, u_-) = 0$ in V . \square

2.A Grushin problems for several commuting operators

2.A.1 Global Grushin problem

Assume that P_1, \dots, P_n are pseudodifferential operators on a compact manifold M , with $P_j \in \Psi^{k_j}(M)$ and $k_j \geq 0$.

Definition 2.A.1. *We say that $\lambda = (\lambda_1, \dots, \lambda_n) \in \mathbb{C}^n$ belongs to the joint spectrum⁹ of P_1, \dots, P_n , if the joint eigenspace*

$$\{u \in C^\infty(M) \mid P_j u = \lambda_j u, \ j = 1, \dots, n\}$$

is nontrivial. (In our situation, one of the operators P_j will be elliptic outside of a compact set, so all joint eigenfunctions will be smooth.)

⁹Strictly speaking, this is the definition of the joint *point* spectrum. However, the operators we study in §2.4 are joint elliptic near the fiber infinity, as in Proposition 2.A.5, thus all joint spectrum is given by eigenvalues.

The goal of this appendix is to extract information about the joint spectrum of P_1, \dots, P_n from certain microlocal information. Essentially, we will construct exact joint eigenfunctions based on approximate eigenfunctions and certain invertibility conditions. The latter will be given in the form of operators A_1, \dots, A_n , with the following properties:

(G1) Each A_j can be represented as $A'_j + A''_j$, where A'_j is compactly microlocalized and has operator norm $O(h^{-r})$; $A''_j \in h^{-r}\Psi^{-k_j}(M)$. Here $r > 0$ is a constant.

(G2) The commutator of any two of the operators $P_1, \dots, P_n, A_1, \dots, A_n$ lies in $h^\infty\Psi^{-\infty}(M)$.

We would like to describe the joint spectrum of P_1, \dots, P_n in a ball of radius $o(h^r)$ centered at zero. First, we consider a situation when there is no joint spectrum:

Proposition 2.A.2. *Assume that conditions (G1) and (G2) hold and additionally,*

$$\sum_{j=1}^n A_j P_j = I \quad \text{mod } h^\infty\Psi^{-\infty}(M).$$

Then there exists $\delta > 0$ such that for h small enough, the ball of radius δh^r centered at zero contains no joint eigenvalues of P_1, \dots, P_n .

Proof. Assume that $u \in L^2(M)$ and $P_j u = \lambda_j u$, where $|\lambda_j| \leq \delta h^r$. Then

$$0 = \sum_{j=1}^n A_j (P_j - \lambda_j) u = (I + h^\infty\Psi^{-\infty})u - \sum_{j=1}^n \lambda_j A_j u.$$

It follows from condition (G1) that $\|A_j\|_{L^2 \rightarrow L^2} = O(h^{-r})$; therefore,

$$\|u\|_{L^2} = O(\delta + h^\infty)\|u\|_{L^2}$$

and we must have $u = 0$ for δ and h small enough. \square

Now, we study the case when the joint spectrum is nonempty. Assume that $S_1 : \mathbb{C} \rightarrow C^\infty(M)$ and $S_2 : \mathcal{D}'(M) \rightarrow \mathbb{C}$ are operators with the following properties:

(G3) Each S_j is compactly microlocalized with operator norm $O(1)$.

(G4) $S_2 S_1 = 1 + O(h^\infty)$.

(G5) If Q is any of the operators $P_1, \dots, P_n, A_1, \dots, A_n$, then $Q S_1 \in h^\infty\Psi^{-\infty}$ and $S_2 Q \in h^\infty\Psi^{-\infty}$.

(G6) We have

$$\sum_{j=1}^n A_j P_j = I - S_1 S_2 \quad \text{mod } h^\infty\Psi^{-\infty}(M).$$

Note that (G5) implies that the image of S_1 consists of $O(h^\infty)$ -approximate joint eigenfunctions. For $n = 1$, one recovers existence of exact eigenfunctions from approximate ones using Grushin problems, based on Schur complement formula; see for example [65, §6]. The proposition below constructs an analogue of these Grushin problems for the case of several operators. This construction is more involved, since we need to combine the fact that P_j commute exactly, needed for the existence of joint spectrum, with microlocal assumptions (G1)–(G6) having $O(h^\infty)$ error. Note also that condition (G2) does not appear in the case $n = 1$.

Proposition 2.A.3. *Assume that the conditions (G1)–(G6) hold and the operators P_1, \dots, P_n commute exactly; that is, $[P_j, P_k] = 0$ for all j, k . Then there exists $\delta > 0$ such that for h small enough, the ball of radius δh^r contains exactly one joint eigenvalue of P_1, \dots, P_n . Moreover, this eigenvalue is $O(h^\infty)$ and the corresponding eigenspace is one dimensional.*

Proof. We prove the proposition in the case $n = 2$ (which is the case we will need in the present chapter); the proof in the general case can be found in Appendix 2.A.3.

For $\lambda = (\lambda_1, \lambda_2) \in \mathbb{C}^2$, consider the operator

$$T(\lambda) = \begin{pmatrix} P_1 - \lambda_1 & -A_2 & S_1 & 0 \\ P_2 - \lambda_2 & A_1 & 0 & S_1 \\ S_2 & 0 & 0 & 0 \\ 0 & S_2 & 0 & 0 \end{pmatrix} : \mathcal{H}_1 \rightarrow \mathcal{H}_2;$$

$$\mathcal{H}_1 = L^2(M) \oplus H_h^{-k_1 - k_2}(M) \oplus \mathbb{C}^2, \quad \mathcal{H}_2 = H_h^{-k_1}(M) \oplus H_h^{-k_2}(M) \oplus \mathbb{C}^2.$$

The conditions (G1)–(G6) imply that for

$$Q = \begin{pmatrix} A_1 & A_2 & S_1 & 0 \\ -P_2 & P_1 & 0 & S_1 \\ S_2 & 0 & 0 & 0 \\ 0 & S_2 & 0 & 0 \end{pmatrix} : \mathcal{H}_2 \rightarrow \mathcal{H}_1,$$

we have $T(0)Q = I + O_{\mathcal{H}_2 \rightarrow \mathcal{H}_2}(h^\infty)$, $QT(0) = I + O_{\mathcal{H}_1 \rightarrow \mathcal{H}_1}(h^\infty)$. By (G1) and (G3), we have $\|Q\|_{\mathcal{H}_2 \rightarrow \mathcal{H}_1} = O(h^{-r})$; therefore, if $\delta > 0$ and h are small enough and $|\lambda| \leq \delta h^r$, then $T(\lambda)$ is invertible and

$$\|T(\lambda)^{-1}\|_{\mathcal{H}_2 \rightarrow \mathcal{H}_1} = O(h^{-r}).$$

Now, let $|\lambda| \leq \delta h^r$ and put

$$(u(\lambda), u_2(\lambda), f(\lambda)) = T(\lambda)^{-1}(0, 0, 1, 0), \quad f(\lambda) = (f_1(\lambda), f_2(\lambda)) \in \mathbb{C}^2.$$

This is the only solution to the following system of equations, which we call global Grushin problem:

$$(P_1 - \lambda_1)u(\lambda) - A_2 u_2(\lambda) + S_1 f_1(\lambda) = 0, \tag{2.A.1}$$

$$(P_2 - \lambda_2)u(\lambda) + A_1 u_2(\lambda) + S_1 f_2(\lambda) = 0, \tag{2.A.2}$$

$$S_2 u(\lambda) = 1, \tag{2.A.3}$$

$$S_2 u_2(\lambda) = 0. \tag{2.A.4}$$

We claim that λ is an element of the joint spectrum if and only if $f(\lambda) = 0$, and in that case, the joint eigenspace is one dimensional and spanned by $u(\lambda)$. First, assume that u is a joint eigenfunction with the eigenvalue λ . Then $T(\lambda)(u, 0, 0, 0) = (0, 0, s, 0)$, where s is some nonzero number; it follows immediately that $f(\lambda) = 0$ and u is a multiple of $u(\lambda)$.

Now, assume that $f(\lambda) = 0$; we need to prove that $u(\lambda)$ is a joint eigenfunction for the eigenvalue λ . By (2.A.1) and (2.A.2), it suffices to show that $u_2(\lambda) = 0$. For that, we multiply (2.A.2) by $P_1 - \lambda_1$ and subtract (2.A.1) multiplied by $P_2 - \lambda_2$; since $f(\lambda) = 0$ and $[P_1, P_2] = 0$, we get

$$((P_1 - \lambda_1)A_1 + (P_2 - \lambda_2)A_2)u_2(\lambda) = 0.$$

Recalling (G6), we get

$$(I - S_1S_2 + O_{H_h^{-k_1-k_2} \rightarrow H_h^{-k_1-k_2}}(\delta + h^\infty))u_2(\lambda) = 0.$$

By (2.A.4), $(I + O(\delta + h^\infty))u_2(\lambda) = 0$ and thus $u_2(\lambda) = 0$. The claim is proven.

It remains to show that the equation $f(\lambda) = 0$ has exactly one root in the disc of radius δh^r centered at zero, and this root is $O(h^\infty)$. For that, let $QT(\lambda) = I - R(\lambda)$; we have

$$R(\lambda) = \begin{pmatrix} \lambda_1 A_1 + \lambda_2 A_2 & 0 & 0 & 0 \\ -\lambda_1 P_2 + \lambda_2 P_1 & 0 & 0 & 0 \\ \lambda_1 S_2 & 0 & 0 & 0 \\ \lambda_2 S_2 & 0 & 0 & 0 \end{pmatrix} + O_{\mathcal{H}_1 \rightarrow \mathcal{H}_1}(h^\infty);$$

$$T(\lambda)^{-1} = (I + R(\lambda) + (I - R(\lambda))^{-1}R(\lambda)^2)Q.$$

One can verify that $R(\lambda)^2Q(0, 0, 1, 0) = O_{\mathcal{H}_1}(h^\infty)$ and then

$$f(\lambda) = \lambda - g(\lambda; h),$$

where $g(\lambda; h) = O(h^\infty)$ uniformly in λ . It remains to apply the contraction mapping principle. \square

Finally, we establish a connection between global Grushin problem and meromorphic resolvent expansions, using some more information about our particular application:

Proposition 2.A.4. *Assume that $n = 2$, P_1, P_2 satisfy the properties stated in the beginning of this subsection, $[P_1, P_2] = 0$, $k_1 > 0$, and $P_1 - \lambda$ is elliptic in the class Ψ^{k_1} for some $\lambda \in \mathbb{C}$. If V is the kernel of P_2 , then by analytic Fredholm theory (see for example [137, Theorem D.4]), the resolvent*

$$R(\lambda) = (P_1 - \lambda)^{-1}|_V : H_h^{-k_1}(M) \cap V \rightarrow L^2(M) \cap V$$

is a meromorphic family of operators in $\lambda \in \mathbb{C}$ with poles of finite rank. Then:

- (1) *Assume that the conditions of Proposition 2.A.2 hold and let $\delta > 0$ be given by this proposition. Then for h small enough, $R(\lambda)$ is holomorphic in $\{|\lambda| < \delta h^r\}$ and $\|R(\lambda)\|_{L^2 \cap V \rightarrow L^2}$ is $O(h^{-r})$ in this region.*

(2) Assume that the conditions of Proposition 2.A.3 hold and let (λ_0, λ_2^0) be the joint eigenvalue and $\delta > 0$ the constant given by this proposition. Suppose that $\lambda_2^0 = 0$. Then for h small enough,

$$R(\lambda) = S(\lambda) + \frac{\Pi}{\lambda - \lambda_0}, \quad |\lambda| < \delta h^r,$$

where $S(\lambda)$ is holomorphic, Π is a rank one operator, and the $L^2 \cap V \rightarrow L^2$ norms of $S(\lambda)$ and Π are $O(h^{-N})$ for some constant N .

Proof. 1. We have

$$A_1(P_1 - \lambda) = I - \lambda A_1 + h^\infty \Psi^{-\infty}(M) \text{ on } V;$$

the right-hand side is invertible for δ small enough. Therefore, R has norm $O(h^{-r})$.

2. We know that $R(\lambda)$ has a pole at λ if and only if there exists nonzero $u \in L^2(M) \cap V$ such that $(P_1 - \lambda)u = 0$; that is, a joint eigenfunction of (P_1, P_2) with joint eigenvalue $(\lambda, 0)$. Therefore, λ_0 is the only pole of $R(\lambda)$ in $\{|\lambda| < \delta h^r\}$.

Now, take $\lambda \neq \lambda_0$, $|\lambda| < \delta h^r$, and assume that $v \in H_h^{-k_1}(M) \cap V$ and $u = R(\lambda)v \in L^2(M) \cap V$. Let $T(\lambda)$ be the family of operators introduced in the proof of Proposition 2.A.3, with $\lambda_1 = \lambda$ and $\lambda_2 = 0$; we know that $T(\lambda)$ is invertible. We represent $T(\lambda)^{-1}$ as a 4×4 operator-valued matrix; let $T_{ij}^{-1}(\lambda)$ be its entries. We have $T(\lambda)(u, 0, 0, 0) = (v, 0, c, 0)$ for some number c . However, then $(u, 0, 0, 0) = T(\lambda)^{-1}(v, 0, c, 0)$; taking the third entry of this equality, we get $T_{31}^{-1}(\lambda)v + T_{33}^{-1}(\lambda)c = 0$. Now, $T_{33}^{-1}(\lambda) = f_1(\lambda)$, with the latter introduced in the proof of Proposition 2.A.3. Therefore, we can compute c in terms of v ; substituting this into the expression for u , we get the following version of the Schur complement formula:

$$R(\lambda) = \left(T_{11}^{-1}(\lambda) - \frac{T_{13}^{-1}(\lambda)T_{31}^{-1}(\lambda)}{f_1(\lambda)} \right) \Big|_V. \quad (2.A.5)$$

Next, by the proof of Proposition 2.A.3, $f_1(\lambda_0) = 0$ and $f_1(\lambda) = \lambda + O(h^\infty)$. Therefore, we may write $f_1(\lambda) = (\lambda - \lambda_0)/g(\lambda)$, with g holomorphic and bounded by $O(1)$. Let u_0 be the joint eigenfunction of (P_1, P_2) with eigenvalue $(\lambda_0, 0)$; then $\Pi = -g(\lambda_0)T_{13}^{-1}(\lambda_0)T_{31}^{-1}(\lambda_0)$ is a rank one operator, as $T_{13}^{-1}(\lambda_0)$ acts $\mathbb{C} \rightarrow V$ and $\Pi u_0 = -(1 + O(h^\infty))u_0$. Since the operators T_{ij}^{-1} are polynomially bounded in h , we are done. \square

2.A.2 Local Grushin problem

In this subsection, we show how to obtain information about the joint spectrum of two operators P_1, P_2 based only on their behavior microlocally near the set where neither of them is elliptic. For that, we use global Grushin problems discussed in the previous subsection. Assume that $P_1 \in \Psi_{\text{cl}}^{k_1}(M)$, $P_2 \in \Psi_{\text{cl}}^{k_2}(M)$ satisfy

(E1) The principal symbol p_{j0} of P_j is real-valued.

(E2) The symbol p_{10} is elliptic in the class $S^{k_1}(M)$ outside of some compact set. As a corollary, the set

$$K = \{(x, \xi) \in T^*M \mid p_{10}(x, \xi) = p_{20}(x, \xi) = 0\}$$

is compact.

Next, assume that A_1, A_2 are compactly microlocalized operators on M such that:

(L1) For each j and every bounded neighborhood U of K , A_j can be represented as $A'_j + A''_j$, where both A'_j and A''_j are compactly microlocalized, $\|A'_j\| = O(h^{-r})$, $\text{WF}_h(A'_j) \subset U \times U$, and $A''_j \in h^{-r}\Psi_{\text{cl}}^{\text{comp}}(M)$. Here $r \geq 0$ is some constant.

(L2) The commutator of any two of the operators P_1, P_2, A_1, A_2 lies in $h^\infty\Psi^{-\infty}(M)$.

Finally, let $S_1 : \mathbb{C} \rightarrow C^\infty(M)$, $S_2 : \mathcal{D}'(M) \rightarrow \mathbb{C}$ be compactly microlocalized operators such that:

(L3) $\|S_j\| = O(1)$ and $\text{WF}_h(S_j) \subset K$.

(L4) $S_2S_1 = 1 + O(h^\infty)$.

(L5) If Q is any of the operators P_1, P_2, A_1, A_2 , then $QS_1 \in h^\infty\Psi^{-\infty}$ and $S_2Q \in h^\infty\Psi^{-\infty}$.

Proposition 2.A.5. *1. If the conditions (E1)–(E2) and (L1)–(L2) hold, and*

$$A_1P_1 + A_2P_2 = I$$

microlocally near $K \times K$, then there exists $\delta > 0$ such that for h small enough, there are no joint eigenvalues of P_1, P_2 in the ball of radius δh^r centered at zero.

2. If the conditions (E1)–(E2) and (L1)–(L5) hold, $[P_1, P_2] = 0$, and

$$A_1P_1 + A_2P_2 = I - S_1S_2 \tag{2.A.6}$$

microlocally near $K \times K$, then there exists $\delta > 0$ such that for h small enough, the ball of radius δh^r centered at zero contains exactly one joint eigenvalue λ of P_1, P_2 . Moreover, $\lambda = O(h^\infty)$ and the corresponding joint eigenspace is one dimensional.

Proof. We will prove part 2; part 1 is handled similarly. Take small $\varepsilon > 0$ and let $\chi_\varepsilon \in C_0^\infty(\mathbb{R})$ be supported in $(-\varepsilon, \varepsilon)$ and equal to 1 on $[-\varepsilon/2, \varepsilon/2]$. Also, let $\psi_\varepsilon \in C^\infty(\mathbb{R})$ satisfy $t\psi_\varepsilon(t) = 1 - \chi_\varepsilon(t)$ for all t ; then $\psi_\varepsilon(t) = 0$ for $|t| \leq \varepsilon/2$. The function ψ_ε is a symbol of order -1 , as it is equal to t^{-1} for $|t| \geq \varepsilon$.

By (E1), we can define the operators $\chi_\varepsilon[P_j], \psi_\varepsilon[P_j] \in \Psi_{\text{cl}}^{\text{loc}}(T^*M)$ using the formal functional calculus introduced in §2.3.2. By (E2) and Proposition 2.3.4 $\psi_\varepsilon[P_1] \in \Psi_{\text{cl}}^{-k_1}(M)$, and $\chi_\varepsilon[P_1] \in \Psi_{\text{cl}}^{\text{comp}}$. Therefore, we can define uniquely up to $h^\infty\Psi^{-\infty}$ the operators

$$X_\varepsilon = \chi_\varepsilon[P_1]\chi_\varepsilon[P_2] \in \Psi_{\text{cl}}^{\text{comp}}(M), \quad \psi_\varepsilon[P_1] \in \Psi_{\text{cl}}^{-k_1}(M), \quad \chi_\varepsilon[P_1]\psi_\varepsilon[P_2] \in \Psi_{\text{cl}}^{\text{comp}}(M). \tag{2.A.7}$$

By Proposition 2.3.3, these operators commute with each other and with P_1, P_2 modulo $h^\infty\Psi^{-\infty}$. Let Y be any of the operators in (2.A.7); we will show that it commutes with each A_j modulo $h^\infty\Psi^{-\infty}$. Take a neighborhood U of K so small that $|p_{10}| + |p_{20}| \leq \varepsilon/4$ on U ; then Y is either zero or the identity operator microlocally on U . By (L1), decompose $A_j = A'_j + A''_j$, where $\text{WF}_h(A'_j) \subset U \times U$ and $A''_j \in \Psi_{\text{cl}}^{\text{comp}}$. We have $A_j = A''_j$ microlocally away from $U \times U$; therefore, $[A''_j, P_k] = 0$ microlocally near $T^*M \setminus U$. By Proposition 2.3.3, $[A''_j, Y] = 0$ microlocally near $T^*M \setminus U$; therefore, the commutator $[A_j, Y]$ is compactly microlocalized and $\text{WF}_h([A_j, Y]) \subset U \times U$. However, since $Y = 0$ or $Y = I$ microlocally in U , we have $[A_j, Y] \in h^\infty\Psi^{-\infty}$, as needed.

Since $X_\varepsilon = I$ microlocally near K and $\text{WF}_h(S_j) \subset K$, we get $(I - X_\varepsilon)S_1, S_2(I - X_\varepsilon) \in h^\infty\Psi^{-\infty}$. Multiplying (2.A.6) by X_ε , we get for ε small enough,

$$(X_\varepsilon A_1)P_1 + (X_\varepsilon A_2)P_2 + S_1 S_2 = X_\varepsilon \quad \text{mod } h^\infty\Psi^{-\infty}. \quad (2.A.8)$$

Next, by Proposition 2.3.3

$$\psi_\varepsilon[P_1]P_1 + \chi_\varepsilon[P_1]\psi_\varepsilon[P_2]P_2 = I - X_\varepsilon \quad \text{mod } h^\infty\Psi^{-\infty}. \quad (2.A.9)$$

Adding these up, we get

$$(X_\varepsilon A_1 + \psi_\varepsilon[P_1])P_1 + (X_\varepsilon A_2 + \chi_\varepsilon[P_1]\psi_\varepsilon[P_2])P_2 + S_1 S_2 = I + h^\infty\Psi^{-\infty}. \quad (2.A.10)$$

The operators $P_1, P_2, \tilde{A}_1 = X_\varepsilon A_1 + \psi_\varepsilon[P_1], \tilde{A}_2 = X_\varepsilon A_2 + \chi_\varepsilon[P_1]\psi_\varepsilon[P_2], S_1, S_2$ satisfy the assumptions of Proposition 2.A.3. Applying it, we get the desired spectral result. \square

2.A.3 Proof of Proposition 2.A.3 in the general case

In this subsection, we prove Proposition 2.A.3 for the general case of $n \geq 2$ operators. For simplicity, we assume that $k_1 = \dots = k_n = 0$; that is, each P_j lies in $\Psi^0(M)$. (If this is not the case, one needs to replace $L^2(M)$ below with certain semiclassical Sobolev spaces.)

Let V be the space of all exterior forms on \mathbb{C}^n ; we can represent it as $V_{\text{Even}} \oplus V_{\text{Odd}}$, where

$$V_{\text{Even}} = \bigoplus_{j \geq 0} \Lambda^{2j} \mathbb{C}^n, \quad V_{\text{Odd}} = \bigoplus_{j \geq 0} \Lambda^{2j+1} \mathbb{C}^n$$

are the vector spaces of the even and odd degree forms, respectively. Note that V_{Even} and V_{Odd} have the same dimension. Define the spaces

$$L_{\text{Even}}^2 = L^2(M) \otimes V_{\text{Even}}, \quad L_{\text{Odd}}^2 = L^2(M) \otimes V_{\text{Odd}}, \quad L_V^2 = L^2(M) \otimes V.$$

We call elements of L_V^2 forms. They possess properties similar to those of differential forms; beware though that they are not differential forms in our case. We will use the families of operators (A_j) and (P_j) to define the operators

$$d_P, d_A^* : L_V^2 \rightarrow L_V^2,$$

given by the formulas

$$\begin{aligned} d_P(u \otimes v) &= \sum_{j=1}^n (P_j u) \otimes (e_j \wedge v), \\ d_A^*(u \otimes v) &= \sum_{j=1}^n (A_j u) \otimes (i_{e_j} v); \\ u &\in L^2(M), \quad v \in V. \end{aligned}$$

Here e_1, \dots, e_n is the canonical basis of \mathbb{C}^n . The notation i_{e_j} is used for the interior product by e_j ; this is the adjoint of the operator $v \mapsto e_j \wedge v$ with respect to the inner product on V induced by the canonical bilinear inner product on \mathbb{C}^n . Note that d_P and d_A^* map even forms to odd and vice versa.

A direct calculation shows that under the assumptions (G1)–(G6),

$$(d_P + d_A^*)^2 = I - S_1 S_2 \otimes I_V + O_{\Psi^{-\infty}}(h^\infty). \quad (2.A.11)$$

Here I_V is the identity operator on V , while I is the identity operator on L_V^2 . Moreover, since the operators P_1, \dots, P_n commute exactly, we have

$$d_P^2 = 0. \quad (2.A.12)$$

For $\lambda = (\lambda_1, \dots, \lambda_n) \in \mathbb{C}^n$, define the operator

$$\begin{aligned} T(\lambda) &= \begin{pmatrix} (d_{P-\lambda} + d_A^*)|_{L_{\text{Even}}^2} & S_1 \otimes I_V \\ S_2 \otimes I_V & 0 \end{pmatrix} : \mathcal{H}_1 \rightarrow \mathcal{H}_2, \\ \mathcal{H}_1 &= L_{\text{Even}}^2 \oplus V_{\text{Odd}}, \quad \mathcal{H}_2 = L_{\text{Odd}}^2 \oplus V_{\text{Even}}. \end{aligned}$$

Here $d_{P-\lambda}$ is defined using the operators $P_1 - \lambda_1, \dots, P_n - \lambda_n$ in place of P_1, \dots, P_n . It follows from (2.A.11) that for

$$Q = \begin{pmatrix} (d_P + d_A^*)|_{L_{\text{Odd}}^2} & S_1 \otimes I_V \\ S_2 \otimes I_V & 0 \end{pmatrix} : \mathcal{H}_2 \rightarrow \mathcal{H}_1,$$

we have $QT(0) = I + O_{\mathcal{H}_1 \rightarrow \mathcal{H}_1}(h^\infty)$, $T(0)Q = I + O_{\mathcal{H}_2 \rightarrow \mathcal{H}_2}(h^\infty)$. Moreover, it follows from (G1) and (G3) that $\|Q\|_{\mathcal{H}_2 \rightarrow \mathcal{H}_1} = O(h^{-r})$. Therefore, for $|\lambda| \leq \delta h^r$ and h and $\delta > 0$ small enough, the operator $T(\lambda)$ is invertible, with $\|T(\lambda)^{-1}\|_{\mathcal{H}_2 \rightarrow \mathcal{H}_1} = O(h^{-r})$.

Assume that $|\lambda| \leq \delta h^r$ and let $\mathbf{1} \in V_{\text{Even}}$ be the basic zero-form on \mathbb{C}^n . Put $(\alpha(\lambda), v(\lambda)) = T(\lambda)^{-1}(0, \mathbf{1})$, where $\alpha(\lambda) \in L_{\text{Even}}^2$, $v(\lambda) \in V_{\text{Odd}}$; then $(\alpha(\lambda), v(\lambda))$ is the unique solution to the system

$$\begin{aligned} (d_{P-\lambda} + d_A^*)\alpha(\lambda) + S_1(1) \otimes v(\lambda) &= 0, \\ (S_2 \otimes I_V)\alpha(\lambda) &= \mathbf{1}. \end{aligned} \quad (2.A.13)$$

We further write $v(\lambda) = f(\lambda) + w(\lambda)$, where $f(\lambda)$ is a 1-form and $w(\lambda)$ is a sum of forms of degree 3 or more. Note that both f and w are holomorphic functions of λ , with $f(\lambda) \in \mathbb{C}^n$.

We claim that λ is a joint eigenvalue of P_1, \dots, P_n if and only if $f(\lambda) = 0$. First of all, if u is a joint eigenfunction, then $T(\lambda)(u \otimes \mathbf{1}, 0) = c(0, \mathbf{1})$ for some scalar $c \neq 0$; therefore, $f(\lambda) = 0$ and the joint eigenspace is one dimensional.

Now, assume that $f(\lambda) = 0$. We will prove that the solution to (2.A.13) satisfies $\alpha(\lambda) = u \otimes \mathbf{1}$ for some $u \in L^2(M)$; it follows immediately that $(P_1 - \lambda_1)u = \dots = (P_n - \lambda_n)u = 0$. Let $\alpha = u \otimes \mathbf{1} + \beta$, where β is a sum of forms of degree 2 or higher. Then by (2.A.12),

$$(d_{P-\lambda} + d_A^*)^2(u \otimes \mathbf{1}) \in L^2(M) \otimes \mathbf{1}. \quad (2.A.14)$$

Next, we get from (2.A.13)

$$(S_2 \otimes I_V)(d_{P-\lambda} + d_A^*)\alpha + (1 + O(h^\infty))v = 0.$$

The components of this equation corresponding to odd forms of degree 3 or higher depend only on β and w ; therefore, for h small enough, $w = W\beta$ for some operator W of norm $O(h^{-r})$. Since $f = 0$, we get $v = W\beta$; therefore, by (2.A.14) and (2.A.13) multiplied by $d_{P-\lambda} + d_A^*$,

$$(d_{P-\lambda} + d_A^*)^2\beta + (d_{P-\lambda} + d_A^*)(S_1(1) \otimes W\beta) \in L^2(M) \otimes \mathbf{1}.$$

Taking the components of this equation corresponding to forms of even degree 2 or higher and recalling (2.A.11), we get

$$((I - S_1 S_2) \otimes I_V + O(\delta + h^\infty))\beta = 0.$$

However, $(S_2 \otimes I_V)\beta = 0$ by (2.A.13); therefore,

$$(I + O(\delta + h^\infty))\beta = 0.$$

It follows that $\beta = 0$ and the claim is proven.

It remains to show that the equation $f(\lambda) = 0$ has exactly one solution in the disk of radius δh^r . For that, we write $QT(\lambda) = I - R(\lambda)$,

$$T(\lambda)^{-1} = (I + R(\lambda) + (I - R(\lambda))^{-1}R(\lambda)^2)Q.$$

We have $Q(\lambda)(0, \mathbf{1}) = (S_1(1) \otimes \mathbf{1}, 0)$ and

$$R(\lambda) = \begin{pmatrix} (d_P + d_A^*)d_\lambda & 0 \\ (S_2 \otimes I_V)d_\lambda & 0 \end{pmatrix} + O(h^\infty).$$

Here d_λ is constructed using $\lambda_1, \dots, \lambda_n$ in place of P_1, \dots, P_n . Now, we use that $R(\lambda)^2 Q(0, \mathbf{1}) = O_{\mathcal{H}_1}(h^\infty)$ to conclude that $f(\lambda) = \lambda - g(\lambda; h)$ with $g = O(h^\infty)$; it then remains to use the contraction mapping principle.

2.B Numerical results

2.B.1 Overview

This section describes a procedure for computing the quantization symbol $\mathcal{F}(m, l, k)$ from Theorem 2.1 to an arbitrarily large order in the case

$$l' = l - |k| = O(1). \quad (2.B.1)$$

The reason for the restriction $l' = O(1)$ is because then we can use bottom of the well asymptotics for eigenvalues of the angular operator; otherwise, we would have to deal with nondegenerate trajectories, quantization conditions for which are harder to compute numerically; see for example [25].

We first use the equation (2.2.16); once we get rid of the semiclassical parameter h (remembering that the original problem was h -independent), the number $\omega = \mathcal{F}(m, l, k)$ is the solution to the equation

$$\mathcal{G}^r(m, \omega, k) = \mathcal{G}^\theta(l', \omega, k). \quad (2.B.2)$$

Here $\mathcal{G}^r, \mathcal{G}^\theta$ are the non-semiclassical analogues of $\mathcal{F}^r, \mathcal{F}^\theta$; namely, (2.2.13) and (2.2.15) take the form

$$\begin{aligned} \lambda &= \mathcal{G}^r(m, \omega, k) \sim \sum_{j \geq 0} \mathcal{G}_j^r(m, \omega, k), \\ \lambda &= \mathcal{G}^\theta(l', \omega, k) \sim \sum_{j \geq 0} \mathcal{G}_j^\theta(l', \omega, k), \end{aligned}$$

respectively. The functions $\mathcal{G}_j^r, \mathcal{G}_j^\theta$ are homogeneous of degree $2 - j$ in the following sense:

$$\mathcal{G}_j^r(m, M_s \omega, sk) = s^{2-j} \mathcal{G}_j^r(m, \omega, k), \quad \mathcal{G}_j^\theta(l', M_s \omega, sk) = s^{2-j} \mathcal{G}_j^\theta(l', \omega, k), \quad s > 0. \quad (2.B.3)$$

Here $M_s \omega = s \operatorname{Re} \omega + i \operatorname{Im} \omega$; the lack of dilation in the imaginary part of ω reflects the fact that it is very close to the real axis.

We will describe how to compute $\mathcal{G}_j^r, \mathcal{G}_j^\theta$ for an arbitrary value of j in Appendix 2.B.3. The method is based on a quantization condition for barrier-top resonances, studied in §2.5.3; their computation is explained in Appendix 2.B.2 and a MATLAB implementation and data files for several first QNMs can be found online at <http://math.berkeley.edu/~dyatlov/qnmskds>. We explain why the presented method gives the quantization conditions of Propositions 2.2.6 and 2.2.7, but we do not provide a rigorous proof.

We now compare the pseudopoles given by quantization conditions to QNMs for the Kerr metric¹⁰ computed by the authors of [13] using Leaver's continued fraction method — see [13, §4.6] for an overview of the method and [14, Appendix E] and [15, §IV] for more details.

¹⁰The results of the present chapter do not apply to the Kerr case $\Lambda = 0$, due to lack of control on the scattering resolvent at the asymptotically flat spatial infinity. However, the resonances described by (2.1.2) are generated by trapping, which is located in a compact set; therefore, we can still make sense of the quantization condition and compute approximate QNMs.

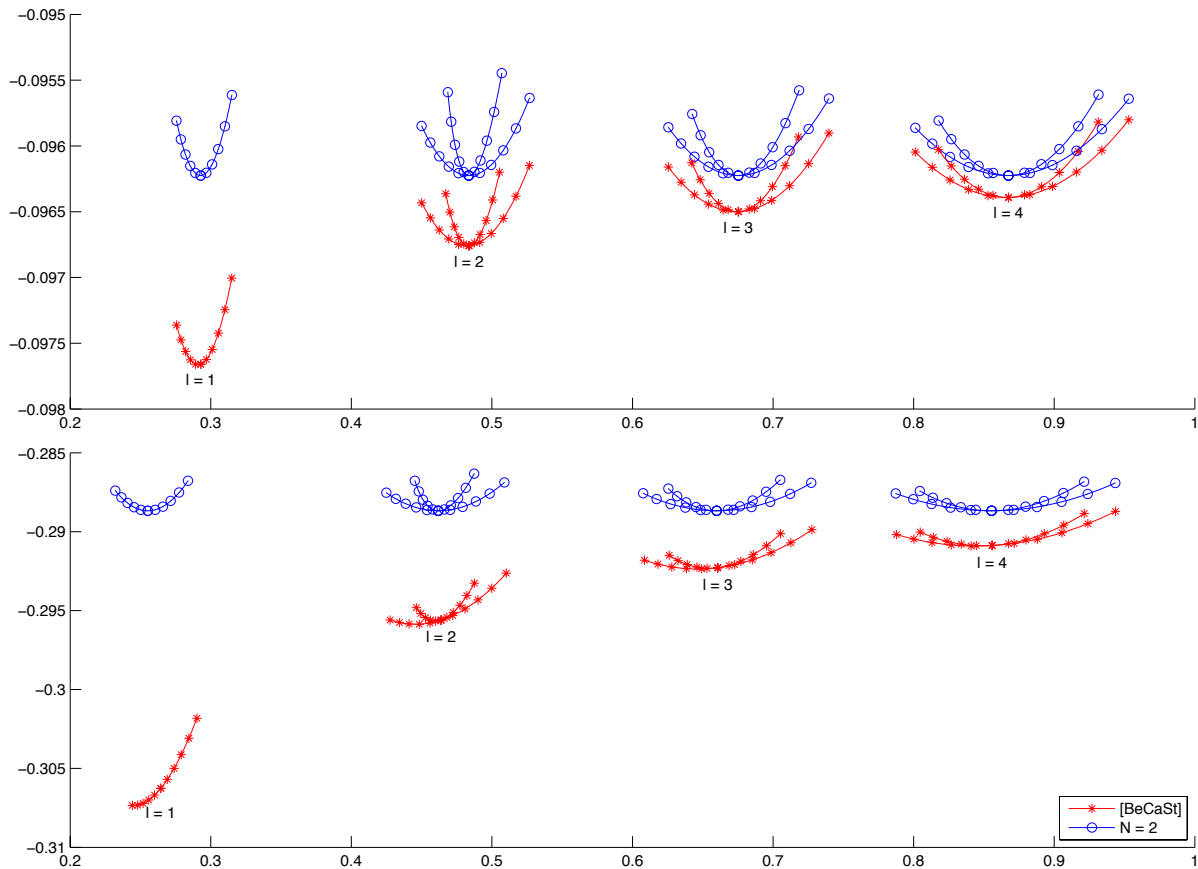

Figure 2.5: Comparison of order 2 approximation to QNMs with the data of [13]. Here $l = 1, \dots, 4$, $k = -l, -l + 1, l - 1, l$ (left to right), and $m = 0$ (top) and 1 (bottom).

The QNM data for the case of scalar perturbations, studied in this chapter, computed using Leaver’s method can be found online at <http://www.phy.olemiss.edu/~berti/qnms.html>.

Figure 2.5 compares the second order approximation to QNMs (that is, solution to the equation (2.B.2) constructed using \mathcal{G}_j^r and \mathcal{G}_j^θ for $j \leq 2$) to the QNMs of [13]. Each branch on the picture shows the trajectory of the QNM with fixed parameters m, l, k for $a \in [0, 0.25]$; the marked points correspond to $a = 0, 0.05, \dots, 0.25$. The branches for same m, l and different k converge to the Schwarzschild QNMs as $a \rightarrow 0$. We see that the approximation gets better when l increases, but worse if one increases m ; this agrees well with the fact that the computed quantization conditions are expected to work when l is large and m is bounded.

The left part of Figure 2.6 compares the second and fourth order approximations with the QNMs of [13] (with the same values of a as before); we see that the fourth order approximation is considerably more accurate than the second order one, and the former is more

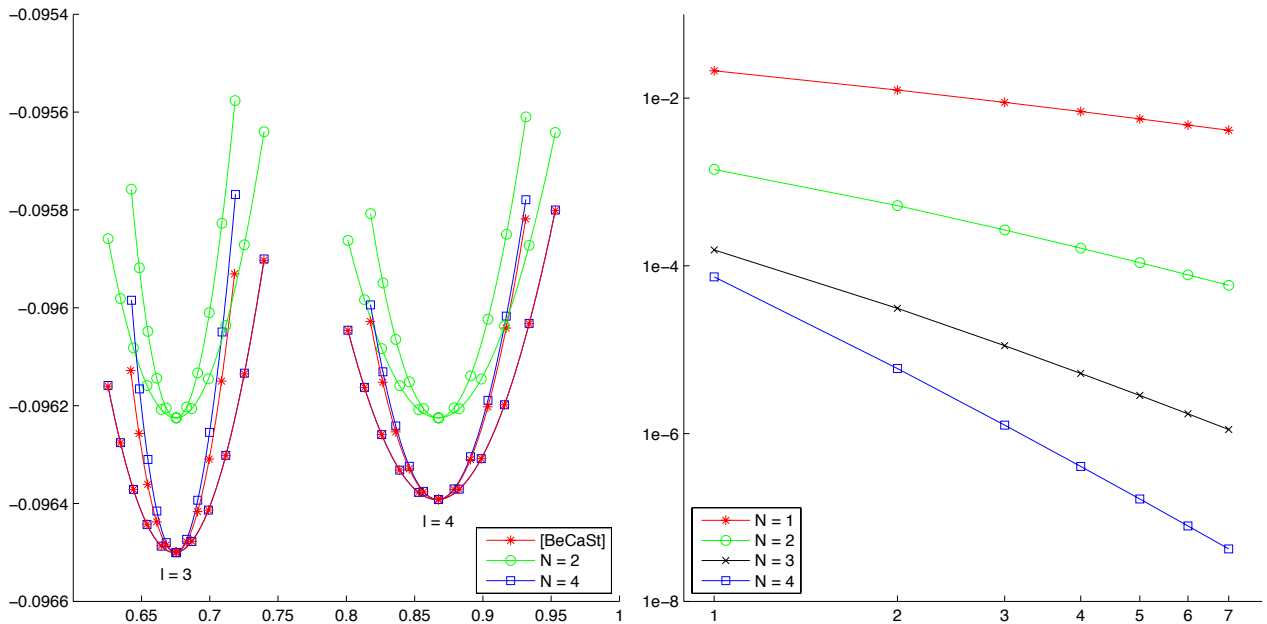

Figure 2.6: Left: comparison of order 2 and 4 approximations to QNMs with the data of [13]. Here $l = 3, 4$, $l' = 0, 1$, and $m = 0$. Right: log-log plot of the error of order 1–4 approximations to QNMs, as compared to [13]. Here $a = 0.1$, $k = l$, $m = 0$, and l , plotted on the x axis, ranges from 1 to 7.

accurate for a smaller value of l' . Finally, the right part of Figure 2.6 is a log-log plot of the error of approximations of degree 1 through 4, as a function of l ; we see that the error decreases polynomially in l .

2.B.2 Barrier-top resonances

Here we study a general spectral problem to which we will reduce both the radial and the angular problems in the next subsection. Our computation is based on the following observation: when the quantization condition of §2.5.3 is satisfied, the function u_+ has the microlocal form (2.5.3), with the symbol behaving like $(r - r_0)^m$ near the trapped set. This can be seen from the proof of Proposition 2.5.6: if $\beta = -ihm$, then $\tilde{u}_\pm^\pm(x) = x^m$ and $B_1\tilde{u}_\pm^\pm$ has to have the form (2.5.3). The calculations below are similar to [39, §3].

Consider the operator

$$P_y = D_y A(y) D_y + B(y; \omega, k). \tag{2.B.4}$$

Here the function $A(y)$ is independent of ω, k , real-valued, and $A(0) > 0$; B is a symbol of

order 2:

$$B(y; \omega, k) \sim \sum_{j \geq 0} B_j(y; \omega, k),$$

with B_j homogeneous of degree $2 - j$ in the sense of (2.B.3). We also require that B_0 be real-valued and

$$B'_0(0; \omega, k) = 0, \quad B''_0(0; \omega, k) < 0.$$

We will describe an algorithm to find the quantization condition for eigenvalues λ of P_y with eigenfunctions having the outgoing WKB form (2.B.6) near $y = 0$; we will compute λ as a symbol of order 2:

$$\lambda \sim \sum_{j \geq 0} \lambda_j(\omega, k), \quad \lambda_j(M_s \omega, s k) = s^{2-j} \lambda(\omega, k), \quad s > 0.$$

More precisely, we will show how to inductively compute each λ_j . The principal part λ_0 is given by the following barrier-top condition:

$$\lambda_0 = B_0(0; \omega, k). \quad (2.B.5)$$

In this case, we have

$$B_0(y; \omega, k) = \lambda_0(\omega, k) - y^2 U_0(y; \omega, k),$$

where U_0 is a smooth function, and $U_0(0) = -V''(0)/2 > 0$. Define the phase function $\psi_0(y; \omega, k)$ such that

$$\psi'_0(y; \omega, k) = y \sqrt{U_0(y; \omega, k)/A(y)};$$

note that ψ_0 is homogeneous of degree 1. We will look for eigenfunctions of the WKB form

$$u(y; \omega, k) = e^{i\psi_0(y; \omega, k)} a(y; \omega, k), \quad (2.B.6)$$

solving the equation $P_y u = \lambda u$ up to $O(|\omega| + |k|)^{-\infty}$ error near $y = 0$. Here a is a symbol of order zero:

$$a(y; \omega, k) \sim \sum a_j(y; \omega, k),$$

with a_j homogeneous of order $-j$.

Substituting (2.B.6) into the equation $P_y u = \lambda u$ and gathering terms with the same degree of homogeneity, we get the following system of transport equations:

$$\begin{aligned} (L_0 - B_1 + \lambda_1) a_j &= -L_1 a_{j-1} + \sum_{0 < l \leq j} (B_{l+1} - \lambda_{l+1}) a_{j-l}, \quad j \geq 0, \\ L_0 &= 2i\psi'_0 A \partial_y + i(A\psi'_0)' = 2i\sqrt{U_0(y)A(y)} y \partial_y + i(y\sqrt{U_0(y)A(y)})'; \\ L_1 &= \partial_y A(y) \partial_y, \end{aligned} \quad (2.B.7)$$

with the convention $a_{-1} = 0$.

Now, consider the space of infinite sequences

$$\mathbb{C}^\infty = \{\mathbf{a} = (\mathbf{a}^j)_{j=0}^\infty \mid \mathbf{a}^j \in \mathbb{C}\}$$

and the operator $T : C^\infty(\mathbb{R}) \rightarrow \mathbb{C}^\infty$ defined by

$$T(a) = \mathbf{a}, \quad \mathbf{a}_j = \partial_y^j a(0)/j!.$$

Let the operators $\mathbf{L}_j, \mathbf{B}_j : \mathbb{C}^\infty \rightarrow \mathbb{C}^\infty$ be defined by the relations

$$T\mathbf{L}_j = \mathbf{L}_j T, \quad T\mathbf{B}_j = \mathbf{B}_j T.$$

We treat $\mathbf{L}_j, \mathbf{B}_j$ as infinite dimensional matrices. We see that each \mathbf{B}_j is lower triangular, with elements on the diagonal given by $B_j(0)$; $(\mathbf{L}_1)_{jk} = 0$ for $j + 2 < k$. As for \mathbf{L}_0 , due to the factor y in front of the differentiation it is lower triangular and

$$(\mathbf{L}_0)_{jj} = i(2j + 1)\sqrt{U_0(0)A(0)}.$$

One can show that there exists a smooth nonzero function a_0 solving $(L_0 - B_1 + \lambda_1)a_0 = 0$ if and only if one of the diagonal elements of the matrix $\mathbf{L}_0 - \mathbf{B}_1 + \lambda_1$ is zero (the kernel of this matrix being spanned by Ta_0). Let $m \geq 0$ be the index of this diagonal element; this will be a parameter of the quantization condition. We can now find

$$\lambda_1 = B_1(0) - i(2m + 1)\sqrt{U_0(0)A(0)}. \quad (2.B.8)$$

Now, there exists a nonzero functional \mathbf{f} on \mathbb{C}^∞ , such that $\mathbf{f}(\mathbf{a})$ depends only on $\mathbf{a}^0, \dots, \mathbf{a}^m$, and \mathbf{f} vanishes on the image of $\mathbf{L}_0 - \mathbf{B}_1 + \lambda_1$. Moreover, one can show that the equation $(L_0 - B_1 + \lambda_1)a = b$ has a smooth solution a if and only if $\mathbf{f}(Tb) = 0$.

Take a_0 to be a nonzero element of the kernel of $L_0 - B_1 + \lambda_1$; we normalize it so that $\mathbf{f}(Ta_0) = 0$. Put $\mathbf{a}_j = Ta_j$; then the transport equations become

$$(\mathbf{L}_0 - \mathbf{B}_1 + \lambda_1)\mathbf{a}_j = -\mathbf{L}_1\mathbf{a}_{j-1} + \sum_{0 < l \leq j} (\mathbf{B}_{l+1} - \lambda_{l+1})\mathbf{a}_{j-l}, \quad j > 0. \quad (2.B.9)$$

We normalize each a_j so that $\mathbf{f}(\mathbf{a}_j) = 0$ for $j > 0$. The j -th transport equation has a solution if and only if the \mathbf{f} kills the right-hand side, which makes it possible to find

$$\lambda_{j+1} = \mathbf{f}\left(-\mathbf{L}_1\mathbf{a}_{j-1} + \sum_{0 < l < j} \mathbf{B}_{l+1}\mathbf{a}_{j-l}\right), \quad j > 0. \quad (2.B.10)$$

Using the equations (2.B.5), (2.B.8), (2.B.10), and (2.B.9), we can find all λ_j and \mathbf{a}_j inductively.

2.B.3 Radial and angular quantization conditions

We start with the radial quantization condition. Consider the original radial operator

$$\begin{aligned} P_r &= D_r(\Delta_r D_r) + V_r(r; \omega, k), \\ V_r(r; \omega, k) &= -\Delta_r^{-1}(1 + \alpha)^2((r^2 + a^2)\omega - ak)^2. \end{aligned}$$

It has the form (2.B.4), with

$$y = r - r_0, \quad A(y) = \Delta_r, \quad B(y; \omega, k) = V_r(r; \omega, k). \quad (2.B.11)$$

Here r_0 is the point where V_r achieves its maximal value, corresponding to the trapped point x_0 in §2.5.1. Now the previous subsection applies, with the use of the outgoing microlocalization mentioned in the beginning of that subsection. Using (2.B.5) and (2.B.8), we can compute near $a = 0$,

$$\begin{aligned} r_0 &= 3M - \frac{2ak(1 - 9\Lambda M^2)}{9M \operatorname{Re} \omega} + O(a^2(|k|^2 + |\omega|^2)), \\ \mathcal{G}_0^r &= \frac{27M^2}{1 - 9\Lambda M^2} \left(1 - \frac{2ak}{9M^2 \operatorname{Re} \omega} \right) (\operatorname{Re} \omega)^2 + O(a^2(|k|^2 + |\omega|^2)), \\ \mathcal{G}_0^r + \mathcal{G}_1^r &= \left[i(m + 1/2) + \frac{3\sqrt{3}M\omega}{\sqrt{1 - 9\Lambda M^2}} \right]^2 + O(1) \text{ for } a = 0; \end{aligned} \quad (2.B.12)$$

reintroducing the semiclassical parameter, we get the formulas for \mathcal{F}^r in Proposition 2.2.6.

Now, we consider the angular problem. Without loss of generality, we assume that $k > 0$. After the change of variables $y = \cos \theta$, the operator $P_\theta|_{\mathcal{D}'_k}$ takes the form

$$P_y = D_y(1 - y^2)(1 + \alpha y^2)D_y + \frac{(1 + \alpha)^2(a\omega(1 - y^2) - k)^2}{(1 - y^2)(1 + \alpha y^2)}.$$

We are now interested in the bottom of the well asymptotics for the eigenvalues of P_y , with the parameter l' from (2.B.1) playing the role of the quantization parameter m . The critical point for the principal symbol of the operator P_y is $(0, 0)$. To reduce the bottom of the well problem to the barrier-top problem, we formally rescale in the complex plane, introducing the parameter $y' = e^{i\pi/4}y$, so that $(y')^2 = iy^2$. We do not provide a rigorous justification for such an operation; we only note that the WKB solution of (2.B.6) looks like $e^{ic(y')^2}a = e^{-cy^2}a$ near $y = 0$ for some positive constant c ; therefore, it is exponentially decaying away from the origin, reminding one of the exponentially decaying Gaussians featured in the bottom of the well asymptotics (see for example [39, §3] or the discussion following [103, Proposition 4.3]). There is a similar calculation of the bottom of the well resonances based on quantum Birkhoff normal form; see for example [26]. The rescaled operator $P_{y'} = -iP_y$ takes the form (2.B.4), with y' taking the place of y and

$$A(y') = (1 + i(y')^2)(1 - i\alpha(y')^2), \quad B(y'; \omega, k) = -\frac{i(1 + \alpha)^2(a\omega(1 + i(y')^2) - k)^2}{(1 + i(y')^2)(1 - i\alpha(y')^2)}. \quad (2.B.13)$$

We can now formally apply the results of Appendix 2.B.2; note that, even though A and B are not real-valued, we have

$$A(0) = 1, \quad B_0(0) = -i(1 + \alpha)^2(a \operatorname{Re} \omega - k)^2, \quad B_0''(0) < 0.$$

An interesting note is that when $a = 0$ and $k > 0$, the process described in Appendix 2.B.2 gives the spherical harmonics $\lambda = l(l + 1)$ exactly and without the assumption (2.B.1). In fact, the first three terms of the asymptotic expansion of λ sum to $l(l + 1)$ and the remaining terms are zero.

Chapter 3

Resonance projectors and asymptotics for r -normally hyperbolic trapped sets

3.1 Introduction

For a Schrödinger operator $h^2\Delta_g + V(x)$, $V \in C^\infty(X; \mathbb{R})$, on a compact Riemannian manifold (X, g) the Weyl law (see for example [39, Theorem 10.1]) provides an asymptotic for the number of eigenvalues (bound states) $\lambda_j(h)$ as $h \rightarrow 0$:

$$\#(\lambda_j(h) \in [\alpha_0, \alpha_1]) = (2\pi h)^{-n} (\text{Vol}_\sigma(p_V^{-1}([\alpha_0, \alpha_1])) + \mathcal{O}(h)). \quad (3.1.1)$$

Here n is the dimension of X , $p_V(x, \xi) = |\xi|_g^2 + V(x)$ is the (semiclassical) principal symbol of the Schrödinger operator, defined on the cotangent bundle T^*X , and Vol_σ is the symplectic volume on T^*X .

Scattering resonances are a natural generalization of bound states to noncompact manifolds; they are the poles of the meromorphic continuation of the resolvent to the lower half-plane $\{\text{Im } \omega \leq 0\} \subset \mathbb{C}$, see (3.1.3) and §§3.4.3, 3.4.4. However, there are very few results giving Weyl asymptotics of resonances in the style of (3.1.1). The first one is probably due to Regge [101], with some of the following results including [136, 113, 114, 112, 50] – see the discussion of related work below.

This chapter provides a new Weyl asymptotic formula for resonances, under the assumption that the trapped set is r -normally hyperbolic and expansion rates satisfy a pinching condition – see Theorems 3.1 and 3.2. These dynamical assumptions are motivated by the study of black holes, see [79]; this continues the previous work of the author (presented in Chapters 1 and 2, as well as in [46]), and the application to stationary perturbations of Kerr–de Sitter black holes is given in Chapter 4. See also [58] for applications of normally hyperbolic trapping to molecular dynamics. Since the imaginary part of a resonance can be interpreted as the exponential decay rate of the corresponding linear wave, we study *long-living resonances*, that is those in strips of size Ch around the real axis. More precisely, we establish an asymptotic formula for the number of resonances in a band located between two resonance free strips.

Setup. To illustrate the results, we consider semiclassical Schrödinger operators on $X = \mathbb{R}^n$, studied in detail in §3.4.3:

$$P_V := h^2 \Delta + V(x), \quad V \in C_0^\infty(\mathbb{R}^n; \mathbb{R}). \quad (3.1.2)$$

Here $\Delta = -\sum_j \partial_{x_j}^2$ is the Euclidean Laplacian. The results apply under the more general assumptions of §§3.4.1 and 3.5.1, in particular in the setting of even asymptotically hyperbolic manifolds – see §3.4.4 and Appendix 3.A. *Resonances* are the poles of the meromorphic continuation of the resolvent

$$R_V(\omega) = (P_V - \omega^2)^{-1} : L^2(\mathbb{R}^n) \rightarrow H^2(\mathbb{R}^n), \quad \text{Im } \omega > 0, \quad (3.1.3)$$

across the ray $(0, \infty) \subset \mathbb{C}$, as a family of operators $L_{\text{comp}}^2(\mathbb{R}^n) \rightarrow H_{\text{loc}}^2(\mathbb{R}^n)$. For the proofs, it is convenient to consider a different operator with the same set of poles

$$\mathcal{R}(\omega) = \mathcal{P}(\omega)^{-1} : \mathcal{H}_2 \rightarrow \mathcal{H}_1, \quad (3.1.4)$$

where $\mathcal{H}_1 = H_h^2(\mathbb{R}^n)$ is a semiclassical Sobolev space, $\mathcal{H}_2 = L^2(\mathbb{R}^n)$, and $\mathcal{P}(\omega) : \mathcal{H}_1 \rightarrow \mathcal{H}_2$ is constructed from P_V using the method of complex scaling (see §3.4.3).

To formulate dynamical assumptions, let $p_V(x, \xi) = |\xi|^2 + V(x)$, fix energy intervals $[\alpha_0, \alpha_1] \Subset [\beta_0, \beta_1] \subset (0, \infty)$, put $p = \sqrt{p_V}$ on $p_V^{-1}([\beta_0^2, \beta_1^2])$ (see (3.4.4) for the general case) and define the *incoming/outgoing tails* Γ_\pm and the *trapped set* K as

$$\Gamma_\pm := \{\rho \in p_V^{-1}([\beta_0^2, \beta_1^2]) \mid \exp(tH_p)(\rho) \not\rightarrow \infty \text{ as } t \rightarrow \mp\infty\}, \quad K := \Gamma_+ \cap \Gamma_-.$$

Here $\exp(tH_p)$ denotes the Hamiltonian flow of p . We assume that (see §3.5.1 for details) Γ_\pm are sufficiently smooth codimension one submanifolds intersecting transversely at K , which is symplectic, and the flow is *r -normally hyperbolic* for large r in the sense that the minimal expansion rate ν_{\min} of the flow $\exp(tH_p)$ in the directions transverse to K is much greater than the maximal expansion rate μ_{\max} along K – see (3.5.1), (3.5.3), (3.5.4). These assumptions are stable under small smooth perturbations of the symbol p , using the results of [64] – see §3.5.2.

Distribution of resonances. Let ν_{\max} be the maximal expansion rate of the flow $\exp(tH_p)$ in the directions transverse to the trapped set, see (3.5.2). The following theorem provides a resonance free region with a polynomial resolvent bound:

Theorem 3.1. *Let the assumptions of §§3.4.1 and 3.5.1 hold and fix $\varepsilon > 0$. Then for*

$$\text{Re } \omega \in [\alpha_0, \alpha_1], \quad \text{Im } \omega \in [-(\nu_{\min} - \varepsilon)h, 0] \setminus \frac{1}{2}(-(\nu_{\max} + \varepsilon)h, -(\nu_{\min} - \varepsilon)h), \quad (3.1.5)$$

ω is not a resonance and we have the bound¹

$$\|\mathcal{R}(\omega)\|_{\mathcal{H}_2 \rightarrow \mathcal{H}_1} \leq Ch^{-2}. \quad (3.1.6)$$

¹The estimate (3.1.6) implies, in the case (3.1.2), cutoff resolvent bounds $\|\chi R_V(\omega)\chi\|_{L^2 \rightarrow H_h^2} = \mathcal{O}(h^{-2})$ for any fixed $\chi \in C_0^\infty(\mathbb{R}^n)$. This explicit bound improves slightly the bounds on the decay of correlations in [97, Theorem 1].

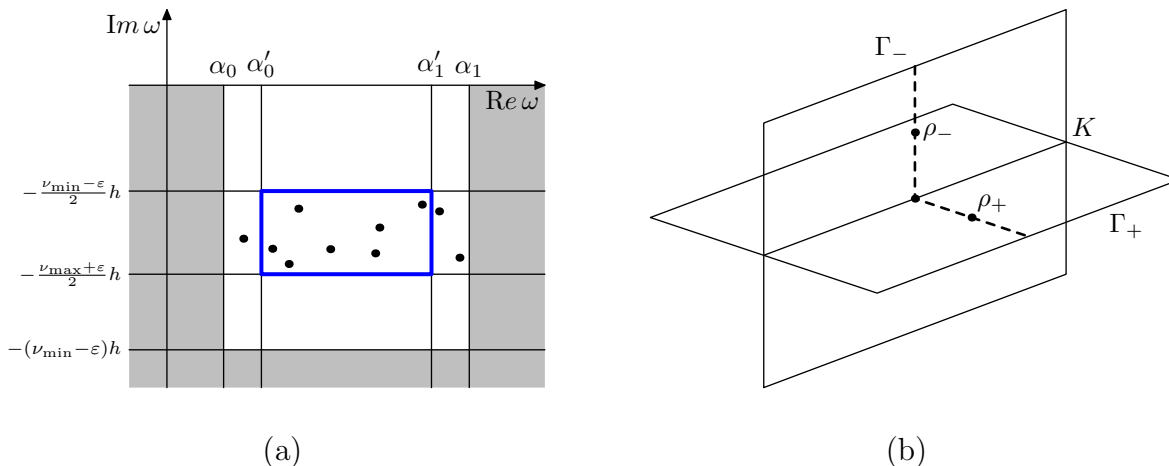

Figure 3.1: (a) An illustration of Theorem 3.2, with (3.1.8) counting resonances in the outlined box. The unshaded regions above and below the box are the resonance-free regions of Theorem 3.1. (b) The canonical relation Λ° , with the flow lines of \mathcal{V}_\pm dashed.

In particular, we get a resonance free strip $\{\text{Im } \omega > -\frac{\nu_{\min} - \varepsilon}{2}h\}$, recovering in our situation the results of [56, 132, 97].

Under the pinching condition

$$\nu_{\max} < 2\nu_{\min}, \quad (3.1.7)$$

we get a *second* resonance free strip $\{\text{Im } \omega \in [-(\nu_{\min} - \varepsilon)h, -(\nu_{\max} + \varepsilon)h/2]\}$. We can then count the resonances in the band between the two strips, see Figure 3.1(a):

Theorem 3.2. *Let the assumptions of §§3.4.1 and 3.5.1 and the condition (3.1.7) hold. Fix $\varepsilon > 0$ such that $\nu_{\max} + \varepsilon < 2(\nu_{\min} - \varepsilon)$. Then, with Res denoting the set of resonances counted with multiplicities (see (3.4.3)),*

$$\begin{aligned} \#(\text{Res} \cap \{\text{Re } \omega \in [\alpha'_0, \alpha'_1], \text{Im } \omega \in \frac{1}{2}[-(\nu_{\max} + \varepsilon)h, -(\nu_{\min} - \varepsilon)h]\}) \\ = (2\pi h)^{1-n}(\text{Vol}_\sigma(K \cap p^{-1}([\alpha'_0, \alpha'_1])) + o(1)), \end{aligned} \quad (3.1.8)$$

as $h \rightarrow 0$, for every $[\alpha'_0, \alpha'_1] \subset (\alpha_0, \alpha_1)$ such that $p^{-1}(\alpha'_j) \cap K$ has zero measure in K . Here Vol_σ denotes the symplectic volume on K , defined by $d\text{Vol}_\sigma = \sigma_S^{n-1}/(n-1)!$.

A band structure similar to the one exhibited in Theorems 3.1 and 3.2, with Weyl laws in each band, has been obtained in [50] for a related setting of Anosov diffeomorphisms, see the discussion below.

The resonance projector. The key tool in proving Theorems 3.1 and 3.2 is a microlocal projector Π corresponding to resonances in the band (3.1.8). We construct it as a *Fourier integral operator* (see §3.3.2), associated to the canonical relation $\Lambda^\circ \subset T^*X \times T^*X$ defined as follows. Let $\mathcal{V}_\pm \subset T\Gamma_\pm$ be the symplectic complements of $T\Gamma_\pm$ in $T_{\Gamma_\pm}(T^*X)$. For

some neighborhoods $\Gamma_{\pm}^{\circ}, K^{\circ}$ of $K \cap p^{-1}([\alpha_0, \alpha_1])$ in Γ_{\pm}, K , respectively, we can define the projections $\pi_{\pm} : \Gamma_{\pm}^{\circ} \rightarrow K^{\circ}$ along the flow lines of \mathcal{V}_{\pm} – see §3.5.4. We define (see also [18])

$$\Lambda^{\circ} := \{(\rho_-, \rho_+) \in \Gamma_-^{\circ} \times \Gamma_+^{\circ} \mid \pi_-(\rho_-) = \pi_+(\rho_+)\}. \quad (3.1.9)$$

Then Λ° is a canonical relation, see §3.5.4; it is pictured on Figure 3.1(b).

We now construct an operator Π with the following properties (see Theorem 3.3 in §3.7.1 for details, including a uniqueness statement):

- (1) Π is a compactly supported Fourier integral operator associated to Λ° ;
- (2) $\Pi^2 = \Pi + \mathcal{O}(h^{\infty})$ microlocally near $K \cap p^{-1}([\alpha_0, \alpha_1])$;
- (3) $[P, \Pi] = \mathcal{O}(h^{\infty})$ microlocally near $K \cap p^{-1}([\alpha_0, \alpha_1])$.

Here P is a pseudodifferential operator equal to $\sqrt{P_V}$ microlocally in $p_V^{-1}([\beta_0^2, \beta_1^2])$ (see Lemma 3.4.3 for the general case). Conditions (2) and (3) mimic idempotency and commutation properties of spectral projectors of self-adjoint operators.

The operator Π is constructed iteratively, solving a degenerate transport equation on each step, with regularity of resulting functions guaranteed by r -normal hyperbolicity. The obtained operator provides a rich microlocal structure, which makes it possible to locally relate our situation to the Taylor expansion, ultimately proving Theorems 3.1 and 3.2. See §3.2.1 for a more detailed explanation of the ideas behind the proofs.

Related work. A particular consequence of Theorem 3.1 is a resonance free strip $\{\operatorname{Im} \omega > -\frac{\nu_{\min} - \varepsilon}{2} h\}$. For *normally hyperbolic* trapped sets, such strips (also called spectral gaps) have been obtained by Gérard–Sjöstrand [55] for operators with analytic coefficients and possibly non-smooth Γ_{\pm} ; Wunsch–Zworski [132] for sufficiently smooth Γ_{\pm} , without specifying the size of the gap; and Dolgopyat [40], Liverani [81], and Tsujii [126] for contact Anosov flows. The recent preprint of Nonnenmacher and Zworski [97] gives a gap of optimal size for a variety of normally hyperbolic trapped sets with very weak assumptions on the regularity of Γ_{\pm} ; in our special case, the gap of [97] coincides with the one given by Theorem 3.1. For a related, yet quite different, case of *hyperbolic* trapped sets (where the flow is hyperbolic in all directions, but no assumptions are made on the regularity of Γ_{\pm} and K), such gaps are known under a pressure condition, see [98] and the references given there.

Upper bounds for the number of resonances in strips near the real axis have been proved in different situations, both for normally hyperbolic and for hyperbolic trapping, by Sjöstrand [108], Guillopé–Lin–Zworski [63], Sjöstrand–Zworski [116], Nonnenmacher–Sjöstrand–Zworski [96, 95], Faure–Sjöstrand [48], Datchev–Dyatlov [36], and Datchev–Dyatlov–Zworski [37]; see [95] or [36] for a more detailed overview. The optimal known bounds follow the *fractal Weyl law*,

$$\#(\operatorname{Res} \cap \{\operatorname{Re} \omega \in [\alpha_0, \alpha_1], \quad |\operatorname{Im} \omega| \leq C_0 h\}) \leq Ch^{-1-\delta}. \quad (3.1.10)$$

Here C_0 is any fixed number and $2\delta + 2$ is bigger than the upper Minkowski dimension of the trapped set K (inside T^*X), or equal to it if K is of pure dimension. In our case, $\dim K = 2n - 2$, therefore the Weyl law (3.1.8) saturates the bound (3.1.10).

Much less is known about lower bounds for hyperbolic or normally hyperbolic trapped sets – some special completely integrable cases were studied by Gérard–Sjöstrand [56], Sá Barreto–Zworski [103], and the author (Chapter 2), a lower bound with a smaller power of h^{-1} than (3.1.10) for certain hyperbolic surfaces was proved by Jakobson–Naud [76], and Weyl laws have been established in some situations in [114, 113, 50, 49, 51] – see below. It has been conjectured [94, Definition 6.1] that for C_0 large enough, a lower bound matching (3.1.10) holds, but no such bound for non-integer δ has been proved so far.

There also exists a Weyl asymptotic for surfaces with cusps, see Müller [93]; in this case, the infinite ends of the manifold are so narrow that almost all trajectories are trapped, and the Weyl law in strips coincides with the Weyl law in disks, with a power h^{-n} . Other Weyl asymptotics in large regions in the complex plane have been obtained by Zworski [136] for one-dimensional potential scattering and by Sjöstrand [112] for Schrödinger operators with randomly perturbed potentials.

Finally, some situations where resonances form several bands of different depth were studied in [114, 118, 113, 49, 49, 51]. Sjöstrand–Zworski [114] showed existence of cubic bands of resonances for strictly convex obstacles, under a pinching condition on the curvature, with a Weyl law in each band. Stefanov–Vodev [118] studied the elasticity problem outside of a convex obstacle with Neumann boundary condition and showed existence of resonances $\mathcal{O}((\operatorname{Re}\omega)^{-\infty})$ close to the real line and a gap below this set of resonances; a Weyl law for resonances close to the real line was proved by Sjöstrand–Vodev [113]. A case bearing some similarities to the one considered here, namely contact Anosov diffeomorphisms, has been studied by Faure–Tsuji [50]; their upcoming work [49, 51] will handle contact Anosov flows – the latter can be put in the framework of §3.4.1 using the work of Faure–Sjöstrand [48].

The results of [50, 49, 51] for the dynamical setting include, under a pinching condition, the band structure of resonances (with the first band analogous to the one in Theorem 3.2) and Weyl asymptotics in each band; the trapped set has to be normally hyperbolic, symplectic, and smooth, however the manifolds Γ_{\pm} need only have Hölder regularity, and no assumption of r -normal hyperbolicity is made. These considerably weaker assumptions on regularity are crucial for Anosov flows and maps, as one cannot even expect Γ_{\pm} to be C^2 in most cases. The lower regularity is in part handled by conjugating $\mathcal{P}(\omega)$ by the exponential of an escape function, similar to the one in [37, Lemma 4.2] – this reduces the analysis to an $\mathcal{O}(h^{1/2})$ sized neighborhood of the trapped set. It then suffices to construct only the principal part of the projector Π to first order on the trapped set; such projector is uniquely defined locally on K (by putting the principal symbol to be equal to 1 on K), without the need for the global construction of §3.7.1 or the transport equation (3.2.2). The present chapter however was motivated by resonance expansions on perturbations of slowly rotating black holes, where the more restrictive r -normal hyperbolicity assumption is satisfied and it is important to have an operator Π defined to all orders in h and away, as well as on, the trapped set. Another advantage of such a global operator is the study of resonant states,

see §3.8.5.

3.2 Outline of the argument

In this section, we explain informally the ideas behind the construction of the projector Π and the proofs of Theorems 3.1 and 3.2, list some directions in which the results could possibly be improved, and describe the structure of the chapter.

3.2.1 Ideas of the proofs and concentration of resonant states

Construction of Π . An important tool is the model case (see §3.6.1)

$$X = \mathbb{R}^n, \quad \Gamma_-^0 = \{x_n = 0\}, \quad \Gamma_+^0 = \{\xi_n = 0\}, \quad \Pi^0 f(x', x_n) = f(x', 0). \quad (3.2.1)$$

Any operator satisfying properties (1) and (2) of Π listed in the introduction can be microlocally conjugated to Π^0 (see Proposition 3.6.3 and part 2 of Proposition 3.6.9). However, there is no canonical way of doing this, and to construct Π globally, we need to use property (3), which eventually reduces to solving the transport equation on Γ_\pm

$$H_p a = f, \quad a|_K = 0, \quad (3.2.2)$$

where f is a given smooth function on Γ_\pm with $f|_K = 0$. The solution to (3.2.2) exists and is unique for any normally hyperbolic trapped set, by representing $a(\rho)$ as an exponentially converging integral of f over the forward (Γ_-) or backward (Γ_+) flow line of H_p starting at ρ . However, to know that a lies in C^r we need r -normal hyperbolicity (see Lemma 3.5.2). This explains why r -normal hyperbolicity, and not just normal hyperbolicity, is needed to construct the operator Π .

Proof of Theorem 3.1. The proof in §3.8 is based on positive commutator arguments, with additional microlocal structure coming from the projector Π and the annihilating operators Θ_\pm discussed below. However, here we present a more intuitive (but harder to make rigorous) argument based on propagation by

$$U(t) = e^{-itP/h},$$

which is a Fourier integral operator quantizing the Hamiltonian flow e^{tH_p} (see Proposition 3.3.1). Note that we use not the original operator $\mathcal{P}(\omega)$, but the operator P constructed in Lemma 3.4.3, equal to $\sqrt{\mathcal{P}_V}$ for the case (3.1.2); this means that $U(t)$ is the wave, rather than the Schrödinger, propagator. We will only care about the behavior of $U(t)$ near the trapped set; for this purpose, we introduce a pseudodifferential cutoff \mathcal{X} microlocalized in a neighborhood of K . For a family of functions $f = f(h)$ whose semiclassical wavefront set (as discussed in §3.3.1) is contained in a small neighborhood of $K \cap p^{-1}([\alpha_0, \alpha_1])$, Theorem 3.1

follows from the following two estimates (a rigorous analog of (3.2.3) is Proposition 3.8.1, and of (3.2.4), Proposition 3.8.2): for $t > 0$,

$$\|\mathcal{X}U(t)(1 - \Pi)f\|_{L^2} \leq (Ch^{-1}e^{-(\nu_{\min} - \varepsilon/2)t} + \mathcal{O}(h^\infty))\|f\|_{L^2}, \quad (3.2.3)$$

$$\begin{aligned} C^{-1}e^{-\frac{(\nu_{\max} + \varepsilon/2)t}{2}} \|\mathcal{X}\Pi f\|_{L^2} - \mathcal{O}(h^\infty)\|f\|_{L^2} &\leq \|\mathcal{X}U(t)\Pi f\|_{L^2} \\ &\leq Ce^{-\frac{(\nu_{\min} - \varepsilon/2)t}{2}} \|\mathcal{X}\Pi f\|_{L^2} + \mathcal{O}(h^\infty)\|f\|_{L^2}. \end{aligned} \quad (3.2.4)$$

The estimates (3.2.3) and (3.2.4) are of independent value, as they give information about the long time behavior of solutions to the wave equation, resembling resonance expansions of linear waves; an application to black holes is given in Chapter 4. Note however that these estimates are nontrivial only when $t = \mathcal{O}(\log(1/h))$, because of the $\mathcal{O}(h^\infty)$ error term.

The resonance free region (3.1.5) of Theorem 3.1 is derived from here as follows. Assume that ω is a resonance in (3.1.5). Then there exists a *resonant state*, namely a function $u \in \mathcal{H}_1$ such that $\mathcal{P}(\omega)u = 0$ and $\|u\|_{\mathcal{H}_1} \sim 1$. We formally have $U(t)u = e^{-it\omega/h}u$. Also, u is microlocalized on the outgoing tail Γ_+ , which is propagated by the flow e^{tH_p} towards infinity; this means that if $f := \mathcal{X}_1u$ for a suitably chosen pseudodifferential cutoff \mathcal{X}_1 , then $\Pi u = \Pi f + \mathcal{O}(h^\infty)$ and for $t > 0$,

$$U(t)f = e^{-it\omega/h}f + \mathcal{O}(h^\infty) \quad \text{microlocally near } \text{WF}_h(\mathcal{X}).$$

Since Π commutes with P modulo $\mathcal{O}(h^\infty)$, it also commutes with $U(t)$, which gives

$$\begin{aligned} \mathcal{X}U(t)(1 - \Pi)f &= e^{-it\omega/h}\mathcal{X}(1 - \Pi)f + \mathcal{O}(h^\infty), \\ \mathcal{X}U(t)\Pi f &= e^{-it\omega/h}\mathcal{X}\Pi f + \mathcal{O}(h^\infty). \end{aligned}$$

Since $\text{Im } \omega \geq -(\nu_{\min} - \varepsilon)h$, we take $t = N \log(1/h)$ for arbitrarily large constant N in (3.2.3) to get $\|\mathcal{X}(1 - \Pi)f\|_{L^2} = \mathcal{O}(h^\infty)$. Since $\text{Im } \omega \notin (-(\nu_{\max} + \varepsilon)h/2, -(\nu_{\min} - \varepsilon)h/2)$, by (3.2.4) we get $\|\mathcal{X}\Pi f\|_{L^2} = \mathcal{O}(h^\infty)$. Together, they give $\|\mathcal{X}f\|_{L^2} = \mathcal{O}(h^\infty)$, implying by standard outgoing estimates (see Lemma 3.4.6) that $\|u\|_{\mathcal{H}_1} = \mathcal{O}(h^\infty)$, a contradiction.

We now give an intuitive explanation for (3.2.3) and (3.2.4). We start by considering the model case (3.2.1), with the pseudodifferential cutoff \mathcal{X} replaced by the multiplication operator by some $\chi \in C_0^\infty(\mathbb{R}^n)$. For the operator P , we consider the model (somewhat inappropriate since the actual Hamiltonian vector field H_p is typically nonvanishing on K , contrary to the model case, but reflecting the nature of the flow in the transverse directions) $P = x_n \cdot hD_{x_n} - ih/2$; here the term $-ih/2$ makes P symmetric. We then have in the model case, $p = x_n \xi_n$, $e^{tH_p}(x, \xi) = (x', e^t x_n, \xi', e^{-t} \xi_n)$, $\nu_{\min} = \nu_{\max} = 1$, and

$$U(t)f(x', x_n) = e^{-t/2}f(x', e^{-t}x_n).$$

Then (3.2.3) (in fact, a better estimate with $e^{-3t/2}$ in place of e^{-t} – see the possible improvements subsection below) follows by Taylor expansion at $x_n = 0$. More precisely, we use the following form of this expansion: for $f \in C_0^\infty(\mathbb{R}^n)$,

$$(1 - \Pi^0)f = x_n \cdot g, \quad g(x', x_n) := \frac{f(x', x_n) - f(x', 0)}{x_n}, \quad (3.2.5)$$

and one can show that $\|g\|_{L^2} \leq Ch^{-1}\|f\|_{H_h^1}$, the factor h^{-1} coming from taking one non-semiclassical derivative to obtain g from f (see Lemma 3.6.12). Then $\chi U(t)(1 - \Pi^0)f = \chi U(t)x_n U(-t)U(t)g$, where (by a special case of Egorov's theorem following by direct computation) $\chi U(t)x_n U(-t)$ is a multiplication operator by

$$\chi U(t)x_n U(-t) = \chi(x)e^{-t}x_n = \mathcal{O}(e^{-t}); \quad (3.2.6)$$

this shows that $\|\chi U(t)(1 - \Pi^0)f\|_{L^2} \leq Ce^{-t}\|g\|_{L^2} \leq Ch^{-1}e^{-t}\|f\|_{H_h^1}$ and (3.2.3) follows.

To show (3.2.4) in the model case, we start with the identity

$$\|\chi U(t)\Pi^0 f\|_{L^2} = \|\chi_t \Pi^0 f\|_{L^2}, \quad \chi_t := U(-t)\chi U(t).$$

If $\chi \in C_0^\infty(\mathbb{R}^n)$, then $\chi_t(x) = \chi(x', e^t x_n)$ has shrinking support as $t \rightarrow \infty$. To compare $\|\chi_t \Pi^0 f\|_{L^2}$ to $\|\chi \Pi^0 f\|_{L^2}$, we use the following fact:

$$hD_{x_n} \Pi^0 f = 0. \quad (3.2.7)$$

This implies that for each $a(x) \in C_0^\infty(\mathbb{R}^n)$, the inner product $\langle a \Pi^0 f, \Pi^0 f \rangle$ depends only on the function $b(x') = \int_{\mathbb{R}} a(x', x_n) dx_n$; writing $\|\chi \Pi^0 f\|_{L^2}^2$ and $\|\chi_t \Pi^0 f\|_{L^2}^2$ as inner products, we get $\|\chi_t \Pi^0 f\|_{L^2}^2 = e^{-t} \|\chi \Pi^0 f\|_{L^2}^2$ and (3.2.4) follows.

The proofs of (3.2.3) and (3.2.4) in the general case work as in the model case, once we find appropriate replacements for differential operators x_n and hD_{x_n} in (3.2.5) and (3.2.7). It turns out that one needs to take pseudodifferential operators Θ_\pm solving, microlocally near $K \cap p^{-1}([\alpha_0, \alpha_1])$,

$$\Pi \Theta_- = \mathcal{O}(h^\infty), \quad \Theta_+ \Pi = \mathcal{O}(h^\infty), \quad (3.2.8)$$

then Θ_- is a replacement for x_n and Θ_+ , for hD_{x_n} . Note that Θ_\pm are not unique, in fact solutions to (3.2.8) form one-sided ideals in the algebra of pseudodifferential operators – see §§3.6.4 and 3.7.2. The principal symbols of Θ_\pm are defining functions of Γ_\pm .

Concentration of resonant states. As a byproduct of the discussion above, we obtain new information about microlocal concentration of resonant states, that is, functions $u \in \mathcal{H}_1$ such that $\mathcal{P}(\omega)u = 0$ and $\|u\|_{\mathcal{H}_1} \sim 1$. It is well-known (see for example [98, Theorem 4]) that the wavefront set of u is contained in $\Gamma_+ \cap p^{-1}(\text{Re } \omega)$. The new information we obtain is that if ω is a resonance in the band given by Theorem 3.2 (that is, $\text{Im } \omega > -(\nu_{\min} - \varepsilon)h$), then by (3.2.3), $u = \Pi u + \mathcal{O}(h^\infty)$ microlocally near K . Then by (3.2.8), $\Theta_+ u = \mathcal{O}(h^\infty)$ near K , that is, u solves a pseudodifferential equation; note that the Hamiltonian flow lines of the principal symbol of Θ_+ are transverse to the trapped set. This implies in particular that any corresponding semiclassical defect measure is determined uniquely by a measure on the trapped set which is conditionally invariant under H_p , similarly to the damped wave equation. See Theorem 3.4 in §3.8.5 for details.

Proof of Theorem 3.2. We start with constructing a well-posed Grushin problem, representing resonances as zeroes of a certain Fredholm determinant $F(\omega)$. Using complex analysis (essentially the argument principle), we reduce counting resonances to computing a

contour integral of the logarithmic derivative $F'(\omega)/F(\omega)$, which, taking $\nu_- = -(\nu_{\max} + \varepsilon)/2$, $\nu_+ = -(\nu_{\min} - \varepsilon)/2$, is similar to (see §3.10 for the actual expression)

$$\frac{1}{2\pi i}(\mathcal{I}_- - \mathcal{I}_+), \quad \mathcal{I}_\pm := \int_{\text{Im } \omega = h\nu_\pm} \tilde{\chi}(\omega) \text{Tr}(\Pi \mathcal{R}(\omega)) d\omega$$

for some cutoff function $\tilde{\chi}(\omega)$. The integration is over the region where Theorem 3.1 gives polynomial bounds on the resolvent $\mathcal{R}(\omega)$, and we can use the methods developed for the proof of this theorem to evaluate both integrals, yielding Theorem 3.2. An important additional tool, explaining in particular why the two integrals do not cancel each other, is microlocal analysis in the spectral parameter ω , or equivalently a study of the essential support of the Fourier transform of $\Pi \mathcal{R}(\omega)$ in ω – see §§3.8.4 and 3.10.

3.2.2 Possible improvements

First of all, it would be interesting to see if one could construct further bands of resonances, lying below the one in Theorem 3.2. One expects these bands to have the form

$$\{\text{Im } \omega \in [-(k + 1/2)(\nu_{\max} + \varepsilon)h, -(k + 1/2)(\nu_{\min} - \varepsilon)h]\}, \quad k \in \mathbb{Z}, k \geq 0,$$

and to have a Weyl law in the k -th band under the pinching condition $(k + 1/2)\nu_{\max} < (k + 3/2)\nu_{\min}$. Note that the presence of the second band of resonances improves the size of the second resonance free strip in Theorem 3.1 and gives a weaker pinching condition $\nu_{\max} < 3\nu_{\min}$ for the Weyl law in the first band. The proofs are expected to work similarly to the present chapter, if one constructs a family of operators $\Pi_0 = \Pi, \Pi_1, \dots, \Pi_k$ such that Π_j is h^{-j} times a Fourier integral operator associated to Λ° , $\Pi_j \Pi_k = \mathcal{O}(h^\infty)$, and $[P, \Pi_j] = \mathcal{O}(h^\infty)$ (microlocally near $K \cap p^{-1}([\alpha_0, \alpha_1])$). However, the method of §3.7.1 does not apply directly to construct Π_k for $k > 0$, since one cannot conjugate all Π_j to the model case, which is the base of the crucial Proposition 3.6.9.

Another direction would be to consider the case when the operator P is quantum completely integrable on the trapped set (a notion that needs to be made precise), and derive a quantization condition for resonances like the one for the special case of black holes ([103] and Chapter 2). The author also believes that the results of the present chapter should be adaptable to the situation when Γ_\pm have codimension higher than 1, which makes it possible to revisit the distribution of resonances generated by one closed hyperbolic trajectory, studied in [56].

An interesting special case lying on the intersection of the current work and [50, 49, 51] is given by geodesic flows on compact manifolds of constant negative curvature; the corresponding manifolds Γ_\pm and K are smooth in this situation. While r -normal hyperbolicity does not hold (in fact, $\mu_{\max} = \nu_{\min} = \nu_{\max}$), the rigid algebraic structure of hyperbolic quotients suggests that one could still look for the projector Π as a (smooth) Fourier integral operator – in terms of the construction of §3.7.1, the transport equation (3.2.2), while not

yielding a smooth solution for an arbitrary choice of the right-hand side f , will have a smooth solution for the specific functions f arising in the construction.

Finally, a natural question is improving the $o(1)$ remainder in the Weyl law (3.1.8). Obtaining an $\mathcal{O}(h^\delta)$ remainder for $\delta < 1$ does not seem to require conceptual changes to the microlocal structure of the argument; however, for the $\mathcal{O}(h)$ remainder of Hörmander [73] or the $o(h)$ remainder of Duistermaat–Guillemin [44], one would need a finer analysis of the interaction of the operator Π with the Schrödinger propagator, and more assumptions on the flow on the trapped set might be needed. Moreover, the complex analysis argument of §3.11 does not work in the case of an $\mathcal{O}(h)$ remainder; a reasonable replacement would be to adapt to the considered case the work of Sjöstrand [107] on the damped wave equation.

3.2.3 Structure of the chapter

- In §3.3, we review the tools we need from semiclassical analysis.
- In §3.4, we present a framework which makes it possible to handle resonances and the spatial infinity in an abstract fashion. The assumptions we make are listed in §3.4.1, followed by some useful lemmas (§3.4.2) and applications to Schrödinger operators (§3.4.3) and even asymptotically hyperbolic manifolds (§3.4.4).
- In §3.5, we study r -normally hyperbolic trapped sets, stating the dynamical assumptions (§3.5.1), discussing their stability under perturbations (§3.5.2), and deriving some corollaries (§§3.5.3–3.5.5).
- In §3.6, we study in detail Fourier integral operators associated to Λ° , and in particular properties of operators solving $\Pi^2 = \Pi + \mathcal{O}(h^\infty)$.
- In §3.7, we construct the projector Π and the annihilating operators Θ_\pm .
- In §3.8, we prove Theorem 3.1, establish microlocal estimates on the resolvent, and study the microlocal concentration of resonant states (§3.8.5).
- In §3.9, we formulate a well-posed Grushin problem for $\mathcal{P}(\omega)$, representing resonances as zeroes of a certain Fredholm determinant.
- In §3.10, we prove a trace formula for $\mathcal{R}(\omega)$ microlocally on the image of Π .
- In §3.11, we prove the Weyl asymptotic for resonances (Theorem 3.2).
- In Appendix 3.A, we provide an example of an asymptotically hyperbolic manifold satisfying the dynamical assumptions of §3.5.1.

3.3 Further semiclassical preliminaries

In this section, we review semiclassical pseudodifferential operators, wavefront sets, and Fourier integral operators; the reader is directed to [137, 39] for a detailed treatment and [71, 72, 59] for the closely related microlocal case.

3.3.1 Pseudodifferential operators and microlocalization

Let X be a manifold without boundary. Following [137, §9.3 and 14.2], we consider the symbol classes $S^k(T^*X)$, $k \in \mathbb{R}$, consisting of smooth functions a on the cotangent bundle T^*X satisfying in local coordinates

$$\sup_h \sup_{x \in K} |\partial_x^\alpha \partial_\xi^\beta a(x, \xi; h)| \leq C_{\alpha\beta K} \langle \xi \rangle^{k-|\beta|},$$

for each multiindices α, β and each compact set $K \subset X$. The corresponding class of semiclassical pseudodifferential operators is denoted $\Psi^k(X)$. The residual symbol class $h^\infty S^{-\infty}$ consists of symbols decaying rapidly in h and ξ over compact subsets of X ; the operators in the corresponding class $h^\infty \Psi^{-\infty}$ have Schwartz kernels in $h^\infty C^\infty(X \times X)$. Operators in Ψ^k are bounded, uniformly in h , between the semiclassical Sobolev spaces $H_{h,\text{comp}}^s(X) \rightarrow H_{h,\text{loc}}^{s-k}(X)$, see [137, (14.2.3)] for the definition of the latter.

Note that for noncompact X , we impose no restrictions on the behavior of symbols as $x \rightarrow \infty$. Accordingly, we cannot control the behavior of operators in $\Psi^k(X)$ near spatial infinity; in fact, a priori we only require them to act $C_0^\infty(X) \rightarrow C^\infty(X)$ and on the spaces of distributions $\mathcal{E}'(X) \rightarrow \mathcal{D}'(X)$. However, each $A \in \Psi^k(X)$ can be written as the sum of an $h^\infty \Psi^{-\infty}$ remainder and an operator properly supported uniformly in h – see for example [71, Proposition 18.1.22]. Properly supported pseudodifferential operators act $C_0^\infty \rightarrow C_0^\infty$ and $C^\infty \rightarrow C^\infty$ and therefore can be multiplied with each other, giving an algebra structure on the whole Ψ^k , modulo $h^\infty \Psi^{-\infty}$.

To study the behavior of symbols near fiber infinity, we use the fiber-radial compactified cotangent bundle $\overline{T^*X}$, a manifold with boundary whose interior is diffeomorphic to T^*X and whose boundary $\partial \overline{T^*X}$ is diffeomorphic to the cosphere bundle over X – see for example [128, §2.2]. We will restrict ourselves to the space of *classical symbols*, i.e. those having an asymptotic expansion

$$a(x, \xi; h) \sim \sum_{j \geq 0} h^j a_j(x, \xi),$$

with $a_j \in S^{k-j}$ classical in the sense that $\langle \xi \rangle^{j-k} a_j$ extends to a smooth function on $\overline{T^*X}$. The principal symbol $\sigma(A) := a_0 \in S^k$ of an operator is defined independently of quantization. We say that $A \in \Psi^k$ is elliptic at some $(x, \xi) \in \overline{T^*X}$ if $\langle \xi \rangle^{-k} \sigma(A)$ does not vanish at (x, ξ) .

Another invariant object associated to $A \in \Psi^k(X)$ is its wavefront set $\text{WF}_h(A)$, which is a closed subset of $\overline{T^*X}$; a point $(x, \xi) \in \overline{T^*X}$ does not lie in $\text{WF}_h(A)$ if and only if there exists a neighborhood U of (x, ξ) in $\overline{T^*X}$ such that the full symbol of A (in any quantization)

is in $h^\infty S^{-\infty}$ in this neighborhood. Note that $\text{WF}_h(A) = \emptyset$ if and only if $A = \mathcal{O}(h^\infty)_{\Psi^{-\infty}}$. We say that $A_1 = A_2 + \mathcal{O}(h^\infty)$ *microlocally* in some $U \subset \overline{T^*X}$, if $\text{WF}_h(A - B) \cap U = \emptyset$.

We denote by $\Psi^{\text{comp}}(X)$ the space of all operators $A \in \Psi^0(X)$ such that $\text{WF}_h(A)$ is a compact subset of T^*X , in particular not intersecting the fiber infinity $\partial\overline{T^*X}$. Note that $\Psi^{\text{comp}}(X) \subset \Psi^k(X)$ for all $k \in \mathbb{R}$.

Tempered distributions and operators. Let $u = u(h)$ be an h -dependent family of distributions in $\mathcal{D}'(X)$. We say that u is h -tempered (or polynomially bounded), if for each $\chi \in C_0^\infty(X)$, there exists N such that $\|\chi u\|_{H_h^{-N}} = \mathcal{O}(h^{-N})$. The class of h -tempered distributions is closed under properly supported pseudodifferential operators. For an h -tempered u , define the wavefront set $\text{WF}_h(u)$, a closed subset of $\overline{T^*X}$, as follows: $(x, \xi) \in \overline{T^*X}$ does not lie in $\text{WF}_h(u)$ if and only if there exists a neighborhood U of (x, ξ) in $\overline{T^*X}$ such that for each properly supported $A \in \Psi^0(X)$ with $\text{WF}_h(A) \subset U$, we have $Au = \mathcal{O}(h^\infty)_{C^\infty}$. We have $\text{WF}_h(u) = \emptyset$ if and only if $u = \mathcal{O}(h^\infty)_{C^\infty}$. We say that $u = v + \mathcal{O}(h^\infty)$ microlocally on some $U \subset \overline{T^*X}$ if $\text{WF}_h(u - v) \cap U = \emptyset$.

Let X_1 and X_2 be two manifolds. An operator $B : C_0^\infty(X_1) \rightarrow \mathcal{D}'(X_2)$ is identified with its Schwartz kernel $\mathcal{K}_B(y, x) \in \mathcal{D}'(X_2 \times X_1)$:

$$Bf(y) = \int_{X_1} \mathcal{K}_B(y, x)u(x) dx, \quad u \in \mathcal{C}_0^\infty(X_1). \quad (3.3.1)$$

Here we assume that X_1 is equipped with some smooth density dx ; later, we will also assume that densities on our manifolds are specified when talking about adjoints.

We say that B is h -tempered if \mathcal{K}_B is, and define the wavefront set of B as

$$\text{WF}_h(B) := \{(x, \xi, y, \eta) \in \overline{T^*}(X_1 \times X_2) \mid (y, \eta, x, -\xi) \in \text{WF}_h(\mathcal{K}_B)\}. \quad (3.3.2)$$

If $B \in \Psi^k(X)$, then the wavefront set of B as an h -tempered operator is equal to its wavefront set as a pseudodifferential operator, under the diagonal embedding $\overline{T^*X} \rightarrow \overline{T^*}(X \times X)$.

3.3.2 Lagrangian distributions and Fourier integral operators

We now review the theory of Lagrangian distributions; for details, the reader is directed to [137, Chapters 10–11], [61, Chapter 6], or [130, §2.3], and to [72, Chapter 25] or [59, Chapters 10–11] for the closely related microlocal setting. Here, we only present the relatively simple local part of the theory; geometric constructions of invariant symbols will be done by hand when needed, without studying the structure of the bundles obtained (see §3.6.2). For a more complete discussion, see for example [47, §3].

A semiclassical Lagrangian distribution locally takes the form

$$u(x; h) = (2\pi h)^{-m/2} \int_{X \times \mathbb{R}^m} e^{\frac{i}{h}\Phi(x, \theta)} a(x, \theta; h) d\theta. \quad (3.3.3)$$

Here Φ is a nondegenerate phase function, i.e. a real-valued function defined on an open subset of $X \times \mathbb{R}^m$, for some m , such that the differentials $d(\partial_{\theta_1}\Phi), \dots, d(\partial_{\theta_m}\Phi)$ are linearly

independent on the critical set

$$\mathcal{C}_\Phi := \{(x, \theta) \mid \partial_\theta \Phi(x, \theta) = 0\}.$$

The amplitude $a(x, \theta; h)$ is a classical symbol (that is, having an asymptotic expansion in nonnegative integer powers of h as $h \rightarrow 0$) compactly supported inside the domain of Φ . The resulting function $u(x; h)$ is smooth, compactly supported, h -tempered, and

$$\text{WF}_h(u) \subset \{(x, \partial_x \Phi(x, \theta)) \mid (x, \theta) \in \mathcal{C}_\Phi \cap \text{supp } a\}. \quad (3.3.4)$$

We say that Φ generates the (immersed, and we shrink the domain of Φ to make it embedded) Lagrangian submanifold

$$\Lambda_\Phi := \{(x, \partial_x \Phi(x, \theta)) \mid (x, \theta) \in \mathcal{C}_\Phi\};$$

note that $\text{WF}_h(u) \subset \Lambda_\Phi$. Moreover, if we restrict Φ to \mathcal{C}_Φ and pull it back to Λ_Φ , then $d\Phi$ equals the canonical 1-form ξdx on Λ_Φ .

In general, assume that Λ is an embedded Lagrangian submanifold of T^*X which is moreover *exact* in the sense that the canonical form ξdx is exact on Λ ; we fix an *antiderivative* on Λ , namely a function F such that $\xi dx = dF$ on Λ . (This is somewhat similar to the notion of Legendre distributions, see [91, §11].) Then we say that a compactly supported h -tempered family of distributions u is a (compactly microlocalized) Lagrangian distribution associated to Λ , if u can be written as a finite sum of expressions (3.3.3), with phase functions Φ_j generating open subsets of Λ , plus an $\mathcal{O}(h^\infty)_{C_0^\infty}$ remainder, where Φ_j are normalized (by adding a constant) so that the pull-back to Λ of the restriction of Φ_j to \mathcal{C}_{Φ_j} equals F . (Without such normalization, passing from one phase function to the other produces a factor $e^{\frac{is}{h}}$ for some constant s , which does not preserve the class of classical symbols – this is an additional complication of the theory compared to the nonsemiclassical case.) Denote by $I_{\text{comp}}(\Lambda)$ the class of all Lagrangian distributions associated to Λ . For $u \in I_{\text{comp}}(\Lambda)$, we have $\text{WF}_h(u) \subset \Lambda$; in particular, $\text{WF}_h(u)$ does not intersect the fiber infinity $\partial \overline{T^*X}$.

If now X_1, X_2 are two manifolds of dimensions n_1, n_2 respectively, and $\Lambda \subset T^*X_1 \times T^*X_2$ is an exact canonical relation (with some fixed antiderivative), then an operator $B : C^\infty(X_1) \rightarrow C_0^\infty(X_2)$ is called a (compactly microlocalized) Fourier integral operator associated to Λ , if its Schwartz kernel $\mathcal{K}_B(y, x)$ is $h^{-(n_1+n_2)/4}$ times a Lagrangian distribution associated to

$$\{(y, \eta, x, -\xi) \in T^*(X_1 \times X_2) \mid (x, \xi, y, \eta) \in \Lambda\}.$$

We write $B \in I_{\text{comp}}(\Lambda)$; note that $\text{WF}_h(B) \subset \Lambda$. A particular case is when Λ is the graph of a canonical transformation $\varkappa : U_1 \rightarrow U_2$, with U_j open subsets in T^*X_j . Operators associated to canonical transformations (but not general relations!) are bounded $H_h^s \rightarrow H_h^{s'}$ uniformly in h , for each s, s' .

Compactly microlocalized Fourier integral operators associated to the identity transformation are exactly compactly supported pseudodifferential operators in $\Psi^{\text{comp}}(X)$. An-

other example of Fourier integral operators is given by Schrödinger propagators, see for instance [137, Theorem 10.4]² or [47, Proposition 3.8]:

Proposition 3.3.1. *Assume that $P \in \Psi^{\text{comp}}(X)$ is compactly supported, $\text{WF}_h(P)$ is contained in some compact subset $V \subset T^*X$, and $p = \sigma(P)$ is real-valued. Then for $t \in \mathbb{R}$ bounded by any fixed constant, the operator $e^{-itP/h} : L^2(X) \rightarrow L^2(X)$ is the sum of the identity and a compactly supported operator microlocalized in $V \times V$. Moreover, for each compactly supported $A \in \Psi^{\text{comp}}(X)$, $Ae^{-itP/h}$ and $e^{-itP/h}A$ are smooth families of Fourier integral operators associated to the Hamiltonian flow $e^{tH_p} : T^*X \rightarrow T^*X$.*

Here we put the antiderivative F for the identity transformation to equal zero, and extend it to the antiderivative F_t on the graph of e^{tH_p} by putting

$$F_t(\gamma(0), \gamma(t)) := tp(\gamma(0)) - \int_{\gamma([0,t])} \xi \, dx$$

for each flow line γ of H_p . The corresponding phase function is produced by a solution to the Hamilton–Jacobi equation [137, Lemma 10.5].

We finally discuss products of Fourier integral operators. Assume that $B_j \in I_{\text{comp}}(\Lambda_j)$, $j = 1, 2$, where $\Lambda_1 \subset T^*X_1 \times T^*X_2$ and $\Lambda_2 \subset T^*X_2 \times T^*X_3$ are exact canonical relations. Assume moreover that Λ_1, Λ_2 satisfy the following transversality assumption: the manifolds $\Lambda_1 \times \Lambda_2$ and $T^*X_1 \times \Delta(T^*X_2) \times T^*X_3$, where $\Delta(T^*X_2) \subset T^*X_2 \times T^*X_2$ is the diagonal, intersect transversely inside $T^*X_1 \times T^*X_2 \times T^*X_2 \times T^*X_3$, and their intersection projects diffeomorphically onto $T^*X_1 \times T^*X_3$. Then $B_2B_1 \in I_{\text{comp}}(\Lambda_2 \circ \Lambda_1)$, where

$$\Lambda_2 \circ \Lambda_1 := \{(\rho_1, \rho_3) \mid \exists \rho_2 \in T^*X_2 : (\rho_1, \rho_2) \in \Lambda_1, (\rho_2, \rho_3) \in \Lambda_2\}, \quad (3.3.5)$$

and, if F_j is the antiderivative on Λ_j , then $F_1(\rho_1, \rho_2) + F_2(\rho_2, \rho_3)$ is the antiderivative on $\Lambda_2 \circ \Lambda_1$. See for example [72, Theorem 25.2.3] or [59, Theorem 11.12] for the closely related microlocal case, which is adapted directly to the semiclassical situation.

The transversality condition is always satisfied when at least one of the Λ_j is the graph of a canonical transformation. In particular, one can always multiply a pseudodifferential operator by a Fourier integral operator, and obtain a Fourier integral operator associated to the same canonical relation.

3.3.3 Basic estimates

In this section, we review some standard semiclassical estimates, parametrices, and microlocalization statements.

Throughout the section, we assume that $k, s \in \mathbb{R}$, $P, Q \in \Psi^k(X)$ are properly supported and u, f are h -tempered distributions on X , in the sense of §3.3.1.

We start with the elliptic estimate, see for instance Proposition 2.3.2:

²[137, Theorem 10.4] is stated for self-adjoint P , rather than operators with real-valued principal symbols; however, the proof works similarly in the latter case, with the transport equation acquiring an additional zeroth order term due to the subprincipal part of P .

Proposition 3.3.2. (*Elliptic estimate*) Assume that $Pu = f$. Then:

1. If $A, B \in \Psi^0(X)$ are compactly supported and P, B are elliptic on $\text{WF}_h(A)$, then

$$\|Au\|_{H_h^s} \leq C\|Bf\|_{H_h^{s-k}} + \mathcal{O}(h^\infty). \quad (3.3.6)$$

2. We have

$$\text{WF}_h(u) \subset \text{WF}_h(f) \cup \{\langle \xi \rangle^{-k} \sigma(P) = 0\}. \quad (3.3.7)$$

Proposition 3.3.2 is typically proved using the following fact, which is of independent interest:

Proposition 3.3.3. (*Elliptic parametrix*) If $V \subset \overline{T^*X}$ is compact and P is elliptic on V , then there exists a compactly supported operator $P' \in \Psi^{-k}(X)$ such that $PP' = 1 + \mathcal{O}(h^\infty)$, $P'P = 1 + \mathcal{O}(h^\infty)$ microlocally near V . Moreover, $\sigma(P') = \sigma(P)^{-1}$ near V .

We next give a version of propagation of singularities which allows for a complex absorbing operator Q , see for instance [128, §2.3]:

Proposition 3.3.4. (*Propagation of singularities*) Assume that $\sigma(P)$ is real-valued, $\sigma(Q) \geq 0$, and $(P \pm iQ)u = f$. Then:

1. If $A_1, A_2, B \in \Psi^0(X)$ are compactly supported and for each flow line $\gamma(t)$ of the Hamiltonian field $\pm \langle \xi \rangle^{1-k} H_{\sigma(P)}$ such that $\gamma(0) \in \text{WF}_h(A_1)$, there exists $t \geq 0$ such that A_2 is elliptic at $\gamma(t)$ and B is elliptic on the segment $\gamma([0, t])$, then

$$\|A_1 u\|_{H_h^s} \leq C\|A_2 u\|_{H_h^s} + Ch^{-1}\|Bf\|_{H_h^{s-k+1}} + \mathcal{O}(h^\infty). \quad (3.3.8)$$

2. If $\gamma(t)$, $0 \leq t \leq T$, is a flow line of $\pm \langle \xi \rangle^{1-k} H_{\sigma(P)}$, then

$$\gamma([0, T]) \cap \text{WF}_h(f) = \emptyset, \quad \gamma(T) \notin \text{WF}_h(u) \implies \gamma(0) \notin \text{WF}_h(u).$$

For $Q = 0$, Proposition 3.3.4 can be viewed as a microlocal version of uniqueness of solutions to the Cauchy problem for hyperbolic equations; a corresponding microlocal existence fact is given by

Proposition 3.3.5. (*Hyperbolic parametrix*) Assume that $\sigma(P)$ is real-valued, $\text{WF}_h(f) \subset T^*X$ is compact, $U, V \subset T^*X$ are compactly contained open sets, and for each flow line $\gamma(t)$ of the Hamiltonian field $H_{\sigma(P)}$ such that $\gamma(0) \in \text{WF}_h(f)$, there exists $t \in \mathbb{R}$ such that $\gamma(t) \in U$ and $\gamma(s) \in V$ for all s between 0 and t .

Then there exists an h -tempered family $v(h) \in C_0^\infty(X)$ such that $\text{WF}_h(v) \subset V$ and

$$\|v\|_{L^2} \leq Ch^{-1}\|f\|_{L^2}, \quad \|Pv\|_{L^2} \leq C\|f\|_{L^2}, \quad \text{WF}_h(Pv - f) \subset U.$$

Proof. By applying a microlocal partition of unity to f , we may assume that there exists $T > 0$ (the case $T < 0$ is considered similarly and the case $T = 0$ is trivial by putting $v = 0$) such that for each flow line $\gamma(t)$ of $H_{\sigma(P)}$ such that $\gamma(0) \in \text{WF}_h(f)$, we have $\gamma(T) \in U$

and $\gamma([0, T]) \in V$. Take $\varepsilon \in (0, T)$ such that $\gamma([T - \varepsilon, T]) \subset U$ for each such γ . Since V is compactly contained in T^*X , we may assume that P is compactly supported and $P \in \Psi^{\text{comp}}(X)$. We then take $\chi \in C_0^\infty(-\infty, T)$ such that $\chi = 1$ near $[0, T - \varepsilon]$ and put

$$v := \frac{i}{h} \int_0^T \chi(t) e^{-itP/h} f dt.$$

Then $\|v\|_{L^2} \leq Ch^{-1} \|f\|_{L^2}$ and $\text{WF}_h(v) \subset V$ by Proposition 3.3.1. Integrating by parts, we compute

$$Pv = - \int_0^T \chi(t) \partial_t e^{-itP/h} f dt = f + \int_0^T (\partial_t \chi(t)) e^{-itP/h} f dt;$$

therefore, $\|Pv\|_{L^2} \leq C \|f\|_{L^2}$ and by Proposition 3.3.1, $\text{WF}_h(Pv - f) \subset U$. □

We also need the following version of the sharp Gårding inequality, see [137, Theorem 4.32] or Proposition 1.6.2:

Proposition 3.3.6. (*Sharp Gårding inequality*) *Assume that $A \in \Psi^{\text{comp}}(X)$ is compactly supported and $\text{Re } \sigma(A) \geq 0$ near $\text{WF}_h(u)$. Assume also that $B \in \Psi^{\text{comp}}(X)$ is compactly supported and elliptic on $\text{WF}_h(A) \cap \text{WF}_h(u)$. Then*

$$\text{Re} \langle Au, u \rangle \geq -Ch \|Bu\|_{L^2}^2 - \mathcal{O}(h^\infty).$$

3.4 Abstract framework near infinity

In this section, we provide an abstract microlocal framework for studying resonances; the general assumptions are listed in §3.4.1. Rather than considering resonances as poles of the meromorphic continuation of the cutoff resolvent, we define them as solutions of a nonselfadjoint eigenvalue problem featuring a holomorphic family of Fredholm operators, $\mathcal{P}(\omega)$. We assume that the dependence of the principal symbol of $\mathcal{P}(\omega)$ on ω can be resolved in a convex neighborhood \mathcal{U} of the trapped set, yielding the ω -independent symbol p (and the operator P later in Lemma 3.4.3). Finally, we require the existence of a semiclassically outgoing parametrix for $\mathcal{P}(\omega)$, resolving it modulo an operator microlocalized near the trapped set.

In §3.4.2, we derive several useful corollaries of our assumptions, making it possible to treat spatial infinity as a black box in the following sections. Finally, in §§3.4.3 and 3.4.4, we provide two examples of situations when the assumptions of §3.4.1 (but not necessarily the dynamical assumptions of §3.5.1) are satisfied: Schrödinger operators on \mathbb{R}^n , studied using complex scaling, and Laplacians on even asymptotically hyperbolic manifolds, handled using [128, 127].

3.4.1 General assumptions

Assume that:

- (1) X is a smooth n -dimensional manifold without boundary, possibly noncompact, with a prescribed volume form;
- (2) $\mathcal{P}(\omega) \in \Psi^k(X)$ is a family of properly supported semiclassical pseudodifferential operators depending holomorphically on ω lying in an open simply connected set $\Omega \subset \mathbb{C}$ such that $\mathbb{R} \cap \Omega$ is connected, with principal symbol $\mathbf{p}(x, \xi, \omega)$;
- (3) $\mathcal{H}_1, \mathcal{H}_2$ are h -dependent Hilbert spaces such that $H_{h,\text{comp}}^N(X) \subset \mathcal{H}_j \subset H_{h,\text{loc}}^{-N}(X)$ for some N , with norms of embeddings $\mathcal{O}(h^{-N})$, and $\mathcal{P}(\omega)$ is bounded $\mathcal{H}_1 \rightarrow \mathcal{H}_2$ with norm $\mathcal{O}(1)$;
- (4) for some fixed $[\alpha_0, \alpha_1] \subset \mathbb{R} \cap \Omega$ and $C_0 > 0$, the operator $\mathcal{P}(\omega) : \mathcal{H}_1 \rightarrow \mathcal{H}_2$ is Fredholm of index zero in the region

$$\operatorname{Re} \omega \in [\alpha_0, \alpha_1], \quad |\operatorname{Im} \omega| \leq C_0 h. \quad (3.4.1)$$

Together with invertibility of $\mathcal{P}(\omega)$ in a subregion of (3.4.1) proved in Theorem 3.1, by Analytic Fredholm Theory [137, Theorem D.4] our assumptions imply that

$$\mathcal{R}(\omega) := \mathcal{P}(\omega)^{-1} : \mathcal{H}_2 \rightarrow \mathcal{H}_1 \quad (3.4.2)$$

is a meromorphic family of operators with poles of finite rank for ω satisfying (3.4.1). *Resonances* are defined as poles of $\mathcal{R}(\omega)$. Following [57, Theorem 2.1], we define the multiplicity of a resonance ω_0 as

$$\frac{1}{2\pi i} \operatorname{Tr} \oint_{\omega_0} \mathcal{P}(\omega)^{-1} \partial_\omega \mathcal{P}(\omega) d\omega. \quad (3.4.3)$$

Here \oint_{ω_0} stands for the integral over a contour enclosing ω_0 , but no other poles of $\mathcal{R}(\omega)$. Since $\mathcal{R}(\omega)$ has poles of finite rank, we see that the integral in (3.4.3) yields a finite dimensional operator on \mathcal{H}_1 and thus one can take the trace. The fact that the resulting multiplicity is a positive integer will follow for example from the representation of resonances as zeroes of a Fredholm determinant, in part 1 of Proposition 3.9.5. See also [107, Appendix A].

We next fix a ‘physical region’ \mathcal{U} in phase space, where most of our analysis will take place, in particular the intersection of the trapped set with the relevant energy shell will be contained in \mathcal{U} . The region \mathcal{U} will be contained in a larger region \mathcal{U}' , which is used to determine when trajectories have escaped from \mathcal{U} . (See (3.4.16) and (3.4.21) for the definitions of $\mathcal{U}, \mathcal{U}'$ for the examples we consider.) We assume that:

- (5) $\mathcal{U}' \subset T^*X$ is open and bounded, and each compactly supported $A \in \Psi^{\text{comp}}(X)$ with $\operatorname{WF}_h(A) \subset \mathcal{U}'$ is bounded $L^2 \rightarrow \mathcal{H}_j, \mathcal{H}_j \rightarrow L^2, j = 1, 2$, with norm $\mathcal{O}(1)$;
- (6) $\mathcal{P}(\omega)^* = \mathcal{P}(\omega) + \mathcal{O}(h^\infty)$ microlocally in \mathcal{U}' when $\omega \in \mathbb{R} \cap \Omega$;
- (7) for each $(x, \xi) \in \mathcal{U}'$, the equation $\mathbf{p}(x, \xi, \omega) = 0, \omega \in \Omega$ has unique solution

$$\omega = p(x, \xi). \quad (3.4.4)$$

Moreover, $p(x, \xi) \in \mathbb{R}$ and $\partial_\omega \mathbf{p}(x, \xi, p(x, \xi)) < 0$ for $(x, \xi) \in \mathcal{U}'$;

- (8) $\mathcal{U} \subset \mathcal{U}'$ is a compactly contained open subset, whose closure $\overline{\mathcal{U}}$ is relatively convex with respect to the Hamiltonian flow of p , i.e. if $\gamma(t), 0 \leq t \leq T$, is a flow line of H_p in \mathcal{U}' and $\gamma(0), \gamma(T) \in \overline{\mathcal{U}}$, then $\gamma([0, T]) \subset \overline{\mathcal{U}}$;

Note that for $\omega \in \mathbb{R} \cap \Omega$, Hamiltonian flow lines of p in $\mathcal{U}' \cap p^{-1}(\omega)$ are rescaled Hamiltonian flow lines of $\mathbf{p}(\cdot, \omega)$ in $\{\rho \in \mathcal{U}' \mid \mathbf{p}(\rho, \omega) = 0\}$. The symbol p is typically the square root of the principal symbol of the original Laplacian or Schrödinger operator, see (3.4.17) and (3.4.22).

We can now define the *incoming/outgoing tails* $\Gamma_{\pm} \subset \overline{\mathcal{U}}$ as follows: $\rho \in \overline{\mathcal{U}}$ lies in Γ_{\pm} if and only if $e^{\mp t H_p}(\rho)$ stays in $\overline{\mathcal{U}}$ for all $t \geq 0$. Define the *trapped set* as

$$K := \Gamma_+ \cap \Gamma_-. \quad (3.4.5)$$

Note that Γ_{\pm} and K are closed subsets of $\overline{\mathcal{U}}$ (and thus the sets Γ_{\pm} defined here are smaller than the original Γ_{\pm} defined in the introduction), and $e^{t H_p}(\Gamma_{\pm}) \subset \Gamma_{\pm}$ for $\mp t \geq 0$, thus $e^{t H_p}(K) = K$ for all t . We assume that, with α_0, α_1 defined in (3.4.1),

- (9) $K \cap p^{-1}([\alpha_0, \alpha_1])$ is a nonempty compact subset of \mathcal{U} .

Finally, we assume the existence of a semiclassically outgoing parametrix, which will make it possible to reduce our analysis to a neighborhood of the trapped set in §3.4.2:

- (10) $\mathcal{Q} \in \Psi^{\text{comp}}(X)$ is compactly supported, $\text{WF}_h(\mathcal{Q}) \subset \mathcal{U}$, and the operator

$$\mathcal{R}'(\omega) := (\mathcal{P}(\omega) - i\mathcal{Q})^{-1} : \mathcal{H}_2 \rightarrow \mathcal{H}_1 \quad (3.4.6)$$

satisfies, for ω in (3.4.1),

$$\|\mathcal{R}'(\omega)\|_{\mathcal{H}_2 \rightarrow \mathcal{H}_1} \leq Ch^{-1}; \quad (3.4.7)$$

- (11) for ω in (3.4.1), $\mathcal{R}'(\omega)$ is *semiclassically outgoing* in the following sense: if $(\rho, \rho') \in \text{WF}_h(\mathcal{R}'(\omega))$ and $\rho, \rho' \in \mathcal{U}'$, there exists $t \geq 0$ such that $e^{t H_p}(\rho) = \rho'$ and $e^{s H_p}(\rho) \in \mathcal{U}'$ for $0 \leq s \leq t$. (See Figure 3.2(a) below.)

3.4.2 Some consequences of general assumptions

In this section, we derive several corollaries of the assumptions of §3.4.1, used throughout the rest of the chapter.

Global properties of the flow. We start with two technical lemmas:

Lemma 3.4.1. *Assume that $\rho \in \Gamma_{\pm}$. Then as $t \rightarrow \mp\infty$, the distance $d(e^{t H_p}(\rho), K)$ converges to zero.*

Proof. We consider the case $\rho \in \Gamma_-$. Put $\gamma(t) := e^{t H_p}(\rho)$, then $\gamma(t) \in \Gamma_-$ for all $t \geq 0$. Assume that $d(\gamma(t), K)$ does not converge to zero as $t \rightarrow +\infty$, then there exists a sequence of times $t_j \rightarrow +\infty$ such that $\gamma(t_j)$ does not lie in a fixed neighborhood of K . By passing to a subsequence, we may assume that $\gamma(t_j)$ converge to some $\rho_{\infty} \in \Gamma_- \setminus K$.

Then $\rho_\infty \notin \Gamma_+$; therefore, there exists $T \geq 0$ such that $e^{-TH_p}(\rho_\infty) \notin \bar{\mathcal{U}}$. For j large enough, we have $\gamma(t_j - T) = e^{-TH_p}(\gamma(t_j)) \notin \bar{\mathcal{U}}$ and $t_j \geq T$; this contradicts convexity of $\bar{\mathcal{U}}$ (assumption (8)). \square

Lemma 3.4.2. *Assume that U_1 is a neighborhood of K in $\bar{\mathcal{U}}$. Then there exists a neighborhood U_2 of K in $\bar{\mathcal{U}}$ such that for each flow line $\gamma(t)$, $0 \leq t \leq T$ of H_p in $\bar{\mathcal{U}}$, if $\gamma(0), \gamma(T) \in U_2$, then $\gamma([0, t]) \subset U_1$.*

Proof. Assume the contrary, then there exist flow lines $\gamma_j(t)$, $0 \leq t \leq T_j$, in $\bar{\mathcal{U}}$, such that $d(\gamma_j(0), K) \rightarrow 0$, $d(\gamma_j(T_j), K) \rightarrow 0$, yet $\gamma_j(t_j) \notin U_1$ for some $t_j \in [0, T_j]$. Passing to a subsequence, we may assume that $\gamma_j(t_j) \rightarrow \rho_\infty \in \bar{\mathcal{U}} \setminus K$. Without loss of generality, we assume that $\rho_\infty \notin \Gamma_+$. Then there exists $T > 0$ such that $e^{-TH_p}(\rho_\infty) \in \mathcal{U}' \setminus \bar{\mathcal{U}}$, and thus $e^{-TH_p}(\gamma_j(t_j)) \notin \bar{\mathcal{U}}$ for j large enough. Since $\gamma_j([0, T_j]) \subset \bar{\mathcal{U}}$, we have $t_j \leq T$. By passing to a subsequence, we may assume that $t_j \rightarrow t_\infty \in [0, T]$. However, then $\gamma_j(0) \rightarrow e^{-t_\infty H_p}(\rho_\infty)$, which implies that $e^{-t_\infty H_p}(\rho_\infty) \in \Gamma_+$, contradicting the fact that $\rho_\infty \notin \Gamma_+$. \square

Resolution of dependence on ω . We reduce the operator $\mathcal{P}(\omega)$ microlocally near \mathcal{U} to an operator of the form $P - \omega$, see also [75, §4]:

Lemma 3.4.3. *There exist:*

- a compactly supported $P \in \Psi^{\text{comp}}(X)$ such that $P^* = P$ and $\sigma(P) = p$ near \mathcal{U} , where p is defined in (3.4.4), and
- a family of compactly supported operators $\mathcal{S}(\omega) \in \Psi^{\text{comp}}(X)$, holomorphic in $\omega \in \Omega$, with $\mathcal{S}(\omega)^* = \mathcal{S}(\omega)$ for $\omega \in \mathbb{R} \cap \Omega$ and $\mathcal{S}(\omega)$ elliptic near \mathcal{U} , such that

$$\mathcal{P}(\omega) = \mathcal{S}(\omega)(P - \omega)\mathcal{S}(\omega) + \mathcal{O}(h^\infty) \quad \text{microlocally near } \mathcal{U}. \quad (3.4.8)$$

Proof. We argue by induction, constructing compactly supported operators $P_j, \mathcal{S}_j(\omega) \in \Psi^{\text{comp}}(X)$, such that $P_j^* = P_j$, $\mathcal{S}_j^*(\omega) = \mathcal{S}_j(\omega)$ for $\omega \in \mathbb{R} \cap \Omega$, and $\mathcal{P}(\omega) = \mathcal{S}_j(\omega)(P_j - \omega)\mathcal{S}_j(\omega) + \mathcal{O}(h^{j+1})$ microlocally near \mathcal{U} . It will remain to take the asymptotic limit.

For $j = 0$, it suffices to take any $P_0, \mathcal{S}_0(\omega)$ such that $\sigma(P_0) = p$ and $\sigma(\mathcal{S}_0(\omega))(\rho) = s_0(\rho, \omega)$ near \mathcal{U} , where (with $\mathbf{p}(\cdot, \omega)$ denoting the principal symbol of $\mathcal{P}(\omega)$)

$$\mathbf{p}(\rho, \omega) = s_0(\rho, \omega)^2(p(\rho) - \omega), \quad \rho \in \mathcal{U}';$$

the existence of such s_0 and the fact that it is real-valued for real ω follows from assumption (7).

Now, given $P_j, \mathcal{S}_j(\omega)$ for some $j \geq 0$, we construct $P_{j+1}, \mathcal{S}_{j+1}(\omega)$. We have $\mathcal{P}(\omega) = \mathcal{S}_j(\omega)(P_j - \omega)\mathcal{S}_j(\omega) + h^{j+1}R_j(\omega)$ microlocally near \mathcal{U} , where $R_j(\omega) \in \Psi^{\text{comp}}$ is a holomorphic family of operators and, by assumption (6), $R_j(\omega)^* = R_j(\omega) + \mathcal{O}(h^\infty)$ microlocally near \mathcal{U} when $\omega \in \mathbb{R} \cap \Omega$. We then put $P_{j+1} = P_j + h^{j+1}A_j$, $\mathcal{S}_{j+1}(\omega) = \mathcal{S}_j(\omega) + h^{j+1}B_j(\omega)$, where $\sigma(A_j) = p_j, \sigma(B_j(\omega))(\rho) = s_j(\rho, \omega)$ near \mathcal{U} and

$$\sigma(R_j)(\rho, \omega) = 2s_0(\rho, \omega)s_j(\rho, \omega)(p(\rho) - \omega) + s_0(\rho, \omega)^2p_j(\rho), \quad \rho \in \mathcal{U}'.$$

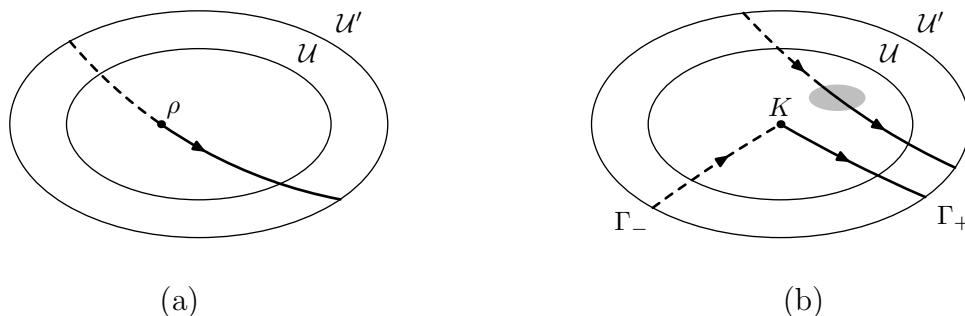

Figure 3.2: (a) Assumption (11), with the undashed part of the flow line of ρ corresponding to $\rho' \in \mathcal{U}'$ such that $(\rho, \rho') \in \text{WF}_h(\mathcal{R}'(\omega))$. (b) An illustration of Lemma 3.4.4, with $\text{WF}_h(f)$ the shaded set and $\text{WF}_h(u)$ containing undashed parts of the flow lines.

The existence of $s_j(\rho, \omega), p_j(\rho)$ and the fact that $p_j(\rho) \in \mathbb{R}$ and $s_j(\rho, \omega) \in \mathbb{R}$ for ρ near \mathcal{U} and $\omega \in \mathbb{R} \cap \Omega$ follow from assumption (7). In particular, we put $p_j(\rho) = \sigma(R_j)(\rho, p(\rho))/s_0(\rho, p(\rho))^2$. \square

Note that, if $u(h) \in \mathcal{H}_1, f(h) \in \mathcal{H}_2$ have norms polynomially bounded in h (and in light of assumption (3) are h -tempered in the sense of §3.3.1), and $\mathcal{P}(\omega)u = f$, then

$$(P - \omega)\mathcal{S}(\omega)u = \mathcal{S}'(\omega)f + \mathcal{O}(h^\infty) \quad \text{microlocally near } \mathcal{U}, \quad (3.4.9)$$

where $\mathcal{S}'(\omega) \in \Psi^{\text{comp}}(X)$ is an elliptic parametrix of $\mathcal{S}(\omega)$ microlocally near \mathcal{U} , constructed in Proposition 3.3.3.

Microlocalization of $\mathcal{R}(\omega)$. Next, we use the semiclassically outgoing parametrix $\mathcal{R}'(\omega)$ from (3.4.6) to derive a key restriction on the wavefront set of functions in the image of $\mathcal{R}(\omega)$, see Figure 3.2(b):

Lemma 3.4.4. *Assume that $u(h) \in \mathcal{H}_1, f(h) \in \mathcal{H}_2$ have norms polynomially bounded in h , $\mathcal{P}(\omega)u = f$ for some $\omega = \omega(h)$ satisfying (3.4.1), and $\text{WF}_h(f) \subset \mathcal{U}$. Then for each $\rho \in \text{WF}_h(u) \cap \mathcal{U}$, if $\gamma(t) = e^{tH_p}(\rho)$ is the corresponding maximally extended flow line in \mathcal{U}' , then either $\gamma(t) \in \overline{\mathcal{U}}$ for all $t \leq 0$ or $\gamma(t) \in \text{WF}_h(f)$ for some $t \leq 0$.*

Proof. By propagation of singularities (Proposition 3.3.4) applied to (3.4.9), we see that either $\gamma(t) \in \overline{\mathcal{U}}$ for all $t \leq 0$, or $\gamma(t) \in \text{WF}_h(f)$ for some $t \leq 0$, or there exists $t \leq 0$ such that $\gamma(t) \in \text{WF}_h(u) \cap (\mathcal{U}' \setminus \overline{\mathcal{U}})$; we need to exclude the third case. However, in this case by convexity of $\overline{\mathcal{U}}$ (assumption (8)), $\gamma(t-s) \notin \overline{\mathcal{U}}$ for all $s \geq 0$; by assumption (11), and since $u = \mathcal{R}'(\omega)(f - i\mathcal{Q}u)$ with $\text{WF}_h(f - i\mathcal{Q}u) \subset \mathcal{U}$, we see that $\gamma(t) \notin \text{WF}_h(u)$, a contradiction. \square

It follows from Lemma 3.4.4 that any resonant state, i.e. a function u such that $\|u\|_{\mathcal{H}_1} \sim 1$ and $\mathcal{P}(\omega)u = 0$, has to satisfy $\text{WF}_h(u) \cap \mathcal{U} \subset \Gamma_+$.

The next statement improves on the parametrix $\mathcal{R}'(\omega)$, inverting the operator $\mathcal{P}(\omega)$ outside of any given neighborhood of the trapped set. One can see this as a geometric control statement (see for instance [19, Theorem 3]).

Lemma 3.4.5. *Let $W \subset \mathcal{U}$ be a neighborhood of $K \cap p^{-1}([\alpha_0, \alpha_1])$ (which is a compact subset of \mathcal{U} by assumption (9)), and assume that $f(h) \in \mathcal{H}_2$ has norm bounded polynomially in h and each $\omega = \omega(h)$ is in (3.4.1). Then there exists $v(h) \in \mathcal{H}_1$, with $f - \mathcal{P}(\omega)v$ compactly supported in X and*

$$\|v\|_{\mathcal{H}_1} \leq Ch^{-1}\|f\|_{\mathcal{H}_2}, \quad \|\mathcal{P}(\omega)v\|_{\mathcal{H}_2} \leq C\|f\|_{\mathcal{H}_2}, \quad \text{WF}_h(f - \mathcal{P}(\omega)v) \subset W.$$

Proof. First of all, take compactly supported $\mathcal{Q}' \in \Psi^{\text{comp}}(X)$ such that $\text{WF}_h(\mathcal{Q}') \subset \mathcal{U}$ and $\mathcal{Q}' = 1$ microlocally near $\text{WF}_h(\mathcal{Q})$ (with \mathcal{Q} defined in assumption (10)), and put

$$v_1 := (1 - \mathcal{Q}')\mathcal{R}'(\omega)f.$$

Then by (3.4.7), $\|v_1\|_{\mathcal{H}_1} \leq Ch^{-1}\|f\|_{\mathcal{H}_2}$ and $\mathcal{P}(\omega)v_1 = f_1$, where

$$f_1 = (1 - \mathcal{Q}' - [\mathcal{P}(\omega), \mathcal{Q}']\mathcal{R}'(\omega) + (1 - \mathcal{Q}')i\mathcal{Q}\mathcal{R}'(\omega))f.$$

Since $(1 - \mathcal{Q}')i\mathcal{Q} = \mathcal{O}(h^\infty)_{\Psi^{-\infty}}$, by (3.4.7) we find $\|f_1\|_{\mathcal{H}_2} \leq C\|f\|_{\mathcal{H}_2}$, $f - f_1$ is compactly supported, and $\text{WF}_h(f - f_1) \subset \text{WF}_h(\mathcal{Q}')$. It is now enough to prove our statement for $f - f_1$ in place of f ; therefore, we may assume that f is compactly supported and

$$\text{WF}_h(f) \subset \text{WF}_h(\mathcal{Q}').$$

Since $\text{WF}_h(\mathcal{Q}')$ is compact, by a microlocal partition of unity we may assume that $\text{WF}_h(f)$ is contained in a small neighborhood of some fixed $\rho \in \text{WF}_h(\mathcal{Q}') \subset \mathcal{U}$. We now consider three cases:

Case 1: $\rho \notin p^{-1}([\alpha_0, \alpha_1])$. Then the operator $\mathcal{P}(\omega)$ is elliptic at ρ , therefore we may assume it is elliptic on $\text{WF}_h(f)$. The function v is then obtained by applying to f an elliptic parametrix of $\mathcal{P}(\omega)$ given in Proposition 3.3.3; we have $f - \mathcal{P}(\omega)v = \mathcal{O}(h^\infty)_{C_0^\infty}$.

Case 2: $\rho \in \Gamma_- \cap p^{-1}([\alpha_0, \alpha_1])$. By Lemma 3.4.1, there exists $t \geq 0$ such that $e^{tH_p}(\rho) \in W$. We may then assume that $e^{tH_p}(\text{WF}_h(f)) \subset W$, and v is then constructed by Proposition 3.3.5, using (3.4.8); we have $\text{WF}_h(v) \subset \mathcal{U}$ and $\text{WF}_h(f - \mathcal{P}(\omega)v) \subset W$.

Case 3: $\rho \notin \Gamma_-$. Then there exists $t \geq 0$ such that $e^{tH_p}(\rho) \in \mathcal{U}' \setminus \bar{\mathcal{U}}$. As in case 2, subtracting from v the parametrix of Proposition 3.3.5, we may assume that f is instead microlocalized in a neighborhood of $e^{tH_p}(\rho)$. Now, put $v = \mathcal{R}'(\omega)f$, with $\mathcal{R}'(\omega)$ defined in (3.4.6); then $\|v\|_{\mathcal{H}_1} \leq Ch^{-1}\|f\|_{\mathcal{H}_2}$ by (3.4.7) and

$$f - \mathcal{P}(\omega)v = -i\mathcal{Q}v.$$

However, by assumption (11), and by convexity of $\bar{\mathcal{U}}$ (assumption (8)), we have $\text{WF}_h(\mathcal{Q}) \cap \text{WF}_h(v) = \emptyset$ and thus $f - \mathcal{P}(\omega)v = \mathcal{O}(h^\infty)_{C_0^\infty}$. \square

Finally, we can estimate the norm of $u \in \mathcal{H}_1$ by the norm of $\mathcal{P}(\omega)u$ and the norm of u microlocally near the trapped set. This can be viewed as an observability statement (see for instance [19, Theorem 2]).

Lemma 3.4.6. *Let $A \in \Psi^{\text{comp}}(X)$ be compactly supported and elliptic on $K \cap p^{-1}([\alpha_0, \alpha_1])$. Then we have for any $u \in \mathcal{H}_1$ and any ω in (3.4.1),*

$$\|u\|_{\mathcal{H}_1} \leq C\|Au\|_{L^2} + Ch^{-1}\|\mathcal{P}(\omega)u\|_{\mathcal{H}_2}. \quad (3.4.10)$$

Proof. By rescaling, we may assume that $u = u(h)$ has $\|u\|_{\mathcal{H}_1} = 1$ and put $f = \mathcal{P}(\omega)u$. Take a neighborhood W of $K \cap p^{-1}([\alpha_0, \alpha_1])$ such that A is elliptic on W . Replacing u by $u - v$, where v is constructed from f in Lemma 3.4.5, we may assume that $\text{WF}_h(f) \subset W$.

Take $\mathcal{Q}', \mathcal{Q}'' \in \Psi^{\text{comp}}(X)$ compactly supported, with $\text{WF}_h(\mathcal{Q}'') \subset \mathcal{U}$, $\mathcal{Q}'' = 1 + \mathcal{O}(h^\infty)$ microlocally near $\text{WF}_h(\mathcal{Q}')$, and $\mathcal{Q}' = 1 + \mathcal{O}(h^\infty)$ microlocally near $\text{WF}_h(\mathcal{Q})$ (with \mathcal{Q} defined in assumption (10)). Then by the elliptic estimate (Proposition 3.3.2),

$$\|\mathcal{Q}'u\|_{\mathcal{H}_1} \leq C\|\mathcal{Q}''u\|_{L^2} + \mathcal{O}(h^\infty), \quad (3.4.11)$$

$$\|[\mathcal{P}(\omega), \mathcal{Q}']u\|_{\mathcal{H}_2} \leq Ch\|\mathcal{Q}''u\|_{L^2} + \mathcal{O}(h^\infty). \quad (3.4.12)$$

Now,

$$(1 - \mathcal{Q}')u = \mathcal{R}'(\omega)((1 - \mathcal{Q}')f - [\mathcal{P}(\omega), \mathcal{Q}']u - i\mathcal{Q}(1 - \mathcal{Q}')u);$$

since $i\mathcal{Q}(1 - \mathcal{Q}') = \mathcal{O}(h^\infty)_{\Psi^{-\infty}}$, we get by (3.4.7) and (3.4.12),

$$\|(1 - \mathcal{Q}')u\|_{\mathcal{H}_1} \leq C\|\mathcal{Q}''u\|_{L^2} + Ch^{-1}\|f\|_{\mathcal{H}_2} + \mathcal{O}(h^\infty);$$

by (3.4.11), it then remains to prove that

$$\|\mathcal{Q}''u\|_{L^2} \leq C\|Au\|_{L^2} + Ch^{-1}\|f\|_{\mathcal{H}_2} + \mathcal{O}(h^\infty).$$

By a microlocal partition of unity, it suffices to estimate $\|Bu\|_{L^2}$ for $B \in \Psi^{\text{comp}}(X)$ compactly supported with $\text{WF}_h(B)$ in a small neighborhood of some $\rho \in \text{WF}_h(\mathcal{Q}'') \subset \mathcal{U}$. We now consider three cases:

Case 1: $\rho \notin p^{-1}([\alpha_0, \alpha_1])$. Then $\mathcal{P}(\omega)$ is elliptic at ρ , therefore we may assume it is elliptic on $\text{WF}_h(B)$. By Proposition 3.3.2, we get $\|Bu\|_{L^2} \leq C\|f\|_{\mathcal{H}_2} + \mathcal{O}(h^\infty)$.

Case 2: there exists $t \leq 0$ such that $e^{tH_p}(\rho) \in W$, therefore we may assume that $e^{tH_p}(\text{WF}_h(B)) \subset W$. Since A is elliptic on W , by Proposition 3.3.4 together with (3.4.8), we get $\|Bu\|_{L^2} \leq C\|Au\|_{L^2} + Ch^{-1}\|f\|_{\mathcal{H}_2} + \mathcal{O}(h^\infty)$.

Case 3: if $\gamma(t) = e^{tH_p}(\rho)$ is the maximally extended trajectory of H_p in \mathcal{U}' , then $\rho \in p^{-1}([\alpha_0, \alpha_1])$ and $\gamma(t) \notin W$ for all $t \leq 0$. By Lemma 3.4.1, we have $\rho \notin \Gamma_+$. Since $\text{WF}_h(f) \subset W$, Lemma 3.4.4 implies that $\rho \notin \text{WF}_h(u)$. We may then assume that $\text{WF}_h(B) \cap \text{WF}_h(u) = \emptyset$ and thus $\|Bu\|_{L^2} = \mathcal{O}(h^\infty)$. \square

3.4.3 Example: Schrödinger operators on \mathbb{R}^n

In this section, we consider the case described in the introduction, namely a Schrödinger operator on $X = \mathbb{R}^n$ with

$$P_V = h^2 \Delta + V(x),$$

where Δ is the Euclidean Laplacian and $V \in C_0^\infty(\mathbb{R}^n; \mathbb{R})$. We will explain how this case fits into the framework of §3.4.1.

To define resonances for P_0 , we use the method of *complex scaling* of Aguilar–Combes [1], which also applies to more general operators and potentials – see [115], [106], and the references given there. Take $R > 0$ large enough so that

$$\text{supp } V \subset \{|x| < R/2\}.$$

Fix the deformation angle $\theta \in (0, \pi/2)$ and consider a deformation $\Gamma_{\theta,R} \subset \mathbb{C}^n$ of \mathbb{R}^n defined by

$$\Gamma_{\theta,R} := \{x + iF_{\theta,R}(x) \mid x \in \mathbb{R}^n\},$$

where $F_{\theta,R} : \mathbb{R}^n \rightarrow \mathbb{R}^n$ is defined in polar coordinates $(r, \varphi) \in [0, \infty) \times \mathbb{S}^{n-1}$ by

$$F_{\theta,R}(r, \varphi) = (f_{\theta,R}(r), \varphi),$$

and the function $f_{\theta,R} \in C^\infty([0, \infty))$ is chosen so that (see Figure 3.3(a))

$$\begin{aligned} f_{\theta,R}(r) &= 0, & r \leq R; & & f_{\theta,R}(r) &= r \tan \theta, & r \geq 2R; \\ f'_{\theta,R}(r) &\geq 0, & r \geq 0; & & \{f'_{\theta,R} = 0\} &= \{f_{\theta,R} = 0\}. \end{aligned}$$

Note that

$$\begin{aligned} \Gamma_{\theta,R} \cap \{|\text{Re } z| \leq R\} &= \mathbb{R}^n \cap \{|\text{Re } z| \leq R\}; \\ \Gamma_{\theta,R} \cap \{|\text{Re } z| \geq 2R\} &= e^{i\theta} \mathbb{R}^n \cap \{|\text{Re } z| \geq 2R\}. \end{aligned}$$

Define the deformed differential operator \tilde{P}_V on $\Gamma_{\theta,R}$ it as follows: $\tilde{P}_V = P_V$ on $\mathbb{R}^n \cap \Gamma_{\theta,R}$, and on the complementing region $\{|\text{Re } z| > R\}$, it is defined by the formula

$$\tilde{P}_V(v) = \sum_{j=1}^n (hD_{z_j})^2 \tilde{v}|_{\Gamma_{\theta,R}},$$

for each $v \in C_0^\infty(\Gamma_{\theta,R} \cap \{|\text{Re } z| > R\})$ and each almost analytic continuation \tilde{v} of v (that is, $\tilde{v}|_{\Gamma_{\theta,R}} = v$ and $\partial_{\bar{z}} \tilde{v}$ vanishes to infinite order on $\Gamma_{\theta,R}$ – the existence of such continuation follows from the fact that $\Gamma_{\theta,R}$ is totally real, that is for each $z \in \Gamma_{\theta,R}$, $T_z \Gamma_{\theta,R} \cap iT_z \Gamma_{\theta,R} = 0$). We identify $\Gamma_{\theta,R}$ with \mathbb{R}^n by the map

$$\iota : \mathbb{R}^n \rightarrow \Gamma_{\theta,R} \subset \mathbb{C}^n, \quad \iota(x) = x + iF_{\theta,R}(x),$$

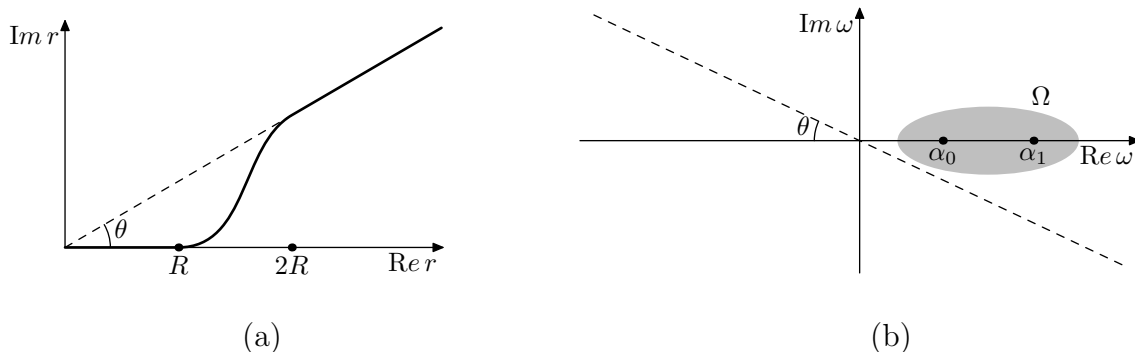

Figure 3.3: (a) The graph of $f_{\theta,r}$. (b) The region where complex scaling provides meromorphic continuation of the resolvent.

so that \tilde{P}_V can be viewed as a second order differential operator on \mathbb{R}^n . Then in polar coordinates (r, φ) , we can write for $r > R$,

$$\tilde{P}_V = \left(\frac{1}{1 + if'_{\theta,R}(r)} h D_r \right)^2 - \frac{(n-1)i}{(r + if_{\theta,R}(r))(1 + if'_{\theta,R}(r))} h^2 D_r + \frac{\Delta_\varphi}{(r + if_{\theta,R}(r))^2},$$

with Δ_φ denoting the Laplacian on the round sphere \mathbb{S}^{n-1} . We have

$$\sigma(\tilde{P}_V) = \frac{|\xi_r|^2}{(1 + if'_{\theta,R}(r))^2} + \frac{|\xi_\varphi|^2}{(r + if_{\theta,R}(r))^2} + V(r, \varphi). \quad (3.4.13)$$

Fix a range of energies $[\alpha_0, \alpha_1] \subset (0, \infty)$ and a bounded open set $\Omega \subset \mathbb{C}$ such that (see Figure 3.3(b))

$$[\alpha_0, \alpha_1] \subset \Omega, \quad \bar{\Omega} \subset \{-\theta < \arg \omega < \pi - \theta\}.$$

For $\omega \in \Omega$, define the operator

$$\mathcal{P}(\omega) = \tilde{P}_V - \omega^2 : \mathcal{H}_1 \rightarrow \mathcal{H}_2, \quad \mathcal{H}_1 := H_h^2(\mathbb{R}^n), \quad \mathcal{H}_2 := L^2(\mathbb{R}^n).$$

Then $\mathcal{P}(\omega)$ is Fredholm $\mathcal{H}_1 \rightarrow \mathcal{H}_2$ for $\omega \in \Omega$. Indeed,

$$\mathcal{P}(\omega) = \cos^2 \theta e^{-2i\theta} h^2 \Delta - \omega^2 \quad \text{on } \{|x| \geq 2R\},$$

thus $\mathcal{P}(\omega)$ is elliptic on $\{|x| \geq 2R\}$, as well as for $|\xi|$ large enough, in the class $S(\langle \xi \rangle^2)$ of [137, §4.4.1] (this class incorporates the behavior of symbols as $x \rightarrow \infty$, in contrast with those used in §3.3.1). Using a construction similar to Lemma 3.3.3, but with symbols in the class $S(\langle \xi \rangle^{-2})$, we can define a parametrix near (both spatial and fiber) infinity, $\mathcal{R}_\infty(\omega)$, with $\|\mathcal{R}_\infty\|_{L^2(\mathbb{R}^n) \rightarrow H_h^2(\mathbb{R}^n)} = \mathcal{O}(1)$ and

$$\begin{aligned} \mathcal{R}_\infty(\omega) \mathcal{P}(\omega) &= 1 + Z(\omega) + \mathcal{O}(h^\infty)_{H_h^2(\mathbb{R}^n) \rightarrow H_h^2(\mathbb{R}^n)}, \\ \mathcal{P}(\omega) \mathcal{R}_\infty(\omega) &= 1 + Z'(\omega) + \mathcal{O}(h^\infty)_{L^2(\mathbb{R}^n) \rightarrow L^2(\mathbb{R}^n)}, \end{aligned} \quad (3.4.14)$$

where $Z(\omega), Z'(\omega) \in \Psi^{\text{comp}}(\mathbb{R}^n)$ are compactly supported inside $\{|x| < 2R + 1\}$. Since $1 + \mathcal{O}(h^\infty)$ is invertible and $Z(\omega), Z'(\omega)$ are compact, we see that $\mathcal{P}(\omega)$ is indeed Fredholm $\mathcal{H}_1 \rightarrow \mathcal{H}_2$. We have thus verified assumptions (1)–(4) of §3.4.1.

The identification of the poles of $\mathcal{R}(\omega)$ with the poles of the meromorphic continuation of the resolvent $R_V(\omega) = (P_V - \omega^2)^{-1}$ defined in (3.1.3) from $\{\text{Im } \omega > 0\}$ to Ω , and in fact, the existence of such a continuation, follows from the following formula (implicit in [106], and discussed in [119]): if $\chi \in C_0^\infty(\mathbb{R}^n)$, $\text{supp } \chi \Subset B(0, R)$, then

$$\chi \mathcal{R}(\omega) \chi = \chi R_V(\omega) \chi. \quad (3.4.15)$$

This is initially valid in $\Omega \cap \{\text{Im } \omega > 0\}$ so that the right-hand side is well-defined, and then by analytic continuation in the region where the left hand side is meromorphic.

Now, we take intervals

$$[\alpha_0, \alpha_1] \Subset [\beta_0, \beta_1] \Subset [\beta'_0, \beta'_1] \subset \Omega \cap (0, \infty)$$

and put

$$\begin{aligned} \mathcal{U}' &:= \{|x| < R, |\xi|^2 + V(x) \in ((\beta'_0)^2, (\beta'_1)^2)\}, \\ \mathcal{U} &:= \{|x| < 3R/4, |\xi|^2 + V(x) \in (\beta_0^2, \beta_1^2)\}. \end{aligned} \quad (3.4.16)$$

Note that $\mathcal{P}(\omega) = P_V - \omega^2$ in \mathcal{U}' ; this verifies assumptions (5) and (6). Assumption (7) is also satisfied, with

$$p(x, \xi) = \sqrt{|\xi|^2 + V(x)}, \quad (x, \xi) \in \mathcal{U}'. \quad (3.4.17)$$

The operators P and $\mathcal{S}(\omega)$ from Lemma 3.4.3 take the form, microlocally near \mathcal{U} ,

$$P = \sqrt{P_V}, \quad \mathcal{S}(\omega) = \sqrt{\sqrt{P_V} + \omega}. \quad (3.4.18)$$

Here the square root is understood in the microlocal sense: for an operator $A \in \Psi^k(X)$ with $\sigma(A) > 0$ on \mathcal{U}' , we define the microlocal square root $\sqrt{A} \in \Psi^{\text{comp}}(X)$ of A in \mathcal{U}' as the (unique modulo $\mathcal{O}(h^\infty)$ microlocally in \mathcal{U}') operator such that $(\sqrt{A})^2 = A + \mathcal{O}(h^\infty)$ microlocally in \mathcal{U}' and $\sigma(\sqrt{A}) = \sqrt{\sigma(A)}$. See for example [59, Lemma 4.6] for details of the construction of the symbol.

Assumption (8), namely convexity of $\bar{\mathcal{U}}$, is satisfied since for each $(x, \xi) \in \mathcal{U}'$, if $|x| \geq R/2$ and $H_p|x|^2 = 0$ at (x, ξ) , then $H_p^2|x|^2 > 0$ at (x, ξ) ; therefore, the function $|x|^2$ cannot attain a local maximum on a trajectory of e^{tH_p} in $\mathcal{U}' \setminus \bar{\mathcal{U}}$. Same observation shows assumption (9); in fact, $K \subset \{|x| \leq R/2\}$.

Finally, for assumptions (10) and (11), we take any compactly supported $\mathcal{Q} \in \Psi^{\text{comp}}(X)$ such that $\text{WF}_h(\mathcal{Q}) \subset \mathcal{U}$ and

$$\sigma(\mathcal{Q}) \geq 0 \quad \text{everywhere}; \quad \sigma(\mathcal{Q}) > 0 \quad \text{on } p^{-1}([\alpha_0, \alpha_1]) \cap \{|x| \leq R/2\}.$$

To verify assumption (10), consider an arbitrary family $u = u(h) \in H_h^2(\mathbb{R}^n)$, with norm bounded polynomially in h , and put

$$f = (\mathcal{P}(\omega) - i\mathcal{Q})u,$$

where ω satisfies (3.4.1). By (3.4.13), and since $\text{Im } \omega = \mathcal{O}(h)$, we find

$$\begin{aligned} \text{Im } \sigma(\mathcal{P}(\omega)) &\leq 0 \quad \text{everywhere;} \\ \{\langle \xi \rangle^{-2} \sigma(\mathcal{P}(\omega)) = 0\} &\subset \{F_{\theta,R}(x) = 0\}. \end{aligned}$$

Note also that $\sigma(\mathcal{P}(\omega)) = |\xi|^2 + V(x) - \omega^2$ on $\{F_{\theta,R}(x) = 0\}$. Together with the convexity property of $|x|^2$ mentioned above, we see that for each $\rho \in T^*X$, there exists $t \leq 0$ such that $\mathcal{P}(\omega) - i\mathcal{Q}$ is elliptic at $\exp(tH_{\text{Re } \sigma(\mathcal{P}(\omega))})(\rho)$. Since $\text{Im } \sigma(\mathcal{P}(\omega) - i\mathcal{Q}) \leq 0$ everywhere, by propagation of singularities with a complex absorbing term (Proposition 3.3.4) and the elliptic estimate (Proposition 3.3.2) we get

$$\|Z(\omega)u\|_{H_h^2} \leq Ch^{-1}\|f\|_{L^2} + \mathcal{O}(h^\infty),$$

where $Z(\omega)$ is defined in (3.4.14). Then by (3.4.14),

$$\|u\|_{H_h^2(\mathbb{R}^n)} \leq C\|f\|_{L^2(\mathbb{R}^n)} + \|Z(\omega)u\|_{H_h^2} + \mathcal{O}(h^\infty) \leq Ch^{-1}\|f\|_{L^2(\mathbb{R}^n)} + \mathcal{O}(h^\infty),$$

proving the estimate (3.4.7) of assumption (10).

Assumption (11) is proved in a similar fashion: assume that $\text{WF}_h(f) \subset \mathcal{U}'$ and $\rho' \in \text{WF}_h(u) \cap \mathcal{U}'$. Denote $\gamma(t) = \exp(tH_{\text{Re } \sigma(\mathcal{P}(\omega))})(\rho')$. Then there exists $t_0 \geq 0$ such that $\mathcal{P}(\omega) - i\mathcal{Q}$ is elliptic at $\gamma(-t_0)$. By Proposition 3.3.4, we see that either $\exp(-tH_{\text{Re } \sigma(\mathcal{P}(\omega))})(\rho') \in \text{WF}_h(f)$ for some $t \in [0, t_0]$ or $\exp(-t_0H_{\text{Re } \sigma(\mathcal{P}(\omega))})(\rho') \in \text{WF}_h(u)$, in which case this point also lies in $\text{WF}_h(f)$ by Proposition 3.3.2; therefore, $\gamma(-t) \in \text{WF}_h(f)$ for some $t \geq 0$. Let t_1 be the minimal nonnegative number such that $\gamma(-t_1) \in \text{WF}_h(f)$; we may assume that $t_1 > 0$. Since $\gamma((-t_1, 0])$ does not intersect $\text{WF}_h(f)$, it also does not intersect the elliptic set of $\mathcal{P}(\omega)$; therefore, $\gamma([-t_1, 0]) \subset \{F_{\theta,R}(x) = 0\}$ and thus $\sigma(\mathcal{P}(\omega)) = p^2 - \omega^2$ on $\gamma([-t_1, 0])$. It follows that $e^{-tH_p}(\rho') \in \text{WF}_h(f)$ for some $t \geq 0$, as required.

3.4.4 Example: even asymptotically hyperbolic manifolds

In this section, we define resonances, in the framework of §3.4.1, for an n -dimensional complete noncompact Riemannian manifold (M, g) which is *asymptotically hyperbolic* in the following sense: M is diffeomorphic to the interior of a smooth manifold with boundary \overline{M} , and for some choice of the boundary defining function $\tilde{x} \in C^\infty(\overline{M})$ and the product decomposition $\{\tilde{x} < \varepsilon\} \sim [0, \varepsilon) \times \partial\overline{M}$, the metric g takes the following form in $\{0 < \tilde{x} < \varepsilon\}$:

$$g = \frac{d\tilde{x}^2 + g_1(\tilde{x}, \tilde{y}, d\tilde{y})}{\tilde{x}^2}. \quad (3.4.19)$$

Here g_1 is a family of Riemannian metrics on $\partial\overline{M}$ depending smoothly on $\tilde{x} \in [0, \varepsilon)$. We moreover require that the metric is *even* in the sense that g_1 is a smooth function of \tilde{x}^2 .

To put the Laplacian Δ_g on M into the framework of §3.4.1, we use the recent construction of Vasy [127]. We follow in part [36, §4.1], see also [36, Appendix B] for a detailed description of the phase space properties of the resulting operator in a model case. Take the space $\overline{M}_{\text{even}}$

obtained from \overline{M} by taking the new boundary defining function $\mu = \tilde{x}^2$ and put (see [127, §3.1])

$$P_1(\omega) = \mu^{-\frac{1}{2} - \frac{n+1}{4}} e^{\frac{i\omega\phi}{h}} (h^2(\Delta_g - (n-1)^2/4) - \omega^2) e^{-\frac{i\omega\phi}{h}} \mu^{-\frac{1}{2} + \frac{n+1}{4}}.$$

Here ϕ is a smooth real-valued function on M such that

$$e^\phi = \mu^{1/2}(1 + \mu)^{-1/4} \quad \text{on } \{0 < \mu < \delta_0\},$$

where $\delta_0 > 0$ is a small constant; the values of ϕ on $\{\mu \geq \delta_0\}$ are chosen as in the paragraph preceding [127, (3.14)]. We can furthermore choose e^ϕ and μ to be equal to 1 near the set $\{\tilde{x} > \varepsilon_0/2\}$, for any fixed $\varepsilon_0 > 0$ (and δ_0 chosen small depending on ε_0) so that

$$P_1(\omega) = h^2(\Delta_g - (n-1)^2/4) - \omega^2 \quad \text{on } \{\tilde{x} > \varepsilon_0/2\}. \quad (3.4.20)$$

The differential operator $P_1(\omega)$ has coefficients smooth up to the boundary of $\overline{M}_{\text{even}}$; then it is possible to find a compact n -dimensional manifold X without boundary such that $\overline{M}_{\text{even}}$ embeds into X as $\{\mu \geq 0\}$ and extend $P_1(\omega)$ to an operator $P_2(\omega) \in \Psi^2(X)$, see [127, §3.5] or [36, Lemma 4.1]. Finally, we fix a complex absorbing operator $Q \in \Psi^2(X)$, with Schwartz kernel supported in the nonphysical region $\{\mu < 0\}$, satisfying the assumptions of [127, §3.5]. We now fix an interval $[\alpha_0, \alpha_1] \subset (0, \infty)$, take $\Omega \subset \mathbb{C}$ a small neighborhood of $[\alpha_0, \alpha_1]$, and put

$$\mathcal{P}(\omega) := P_2(\omega) - iQ, \quad \omega \in \Omega.$$

Fix $C_0 > 0$, take $s > C_0 + 1/2$, and put $\mathcal{H}_2 = H_h^{s-1}(X)$ and

$$\mathcal{H}_1 = \{u \in H_h^s(X) \mid P_2(1)u \in H_h^{s-1}(X)\}, \quad \|u\|_{\mathcal{H}_1}^2 = \|u\|_{H_h^s(X)}^2 + \|P_2(1)u\|_{H_h^{s-1}(X)}^2.$$

It is proved in [127, Theorem 4.3] that for ω satisfying (3.4.1), the operator $\mathcal{P}(\omega) : \mathcal{H}_1 \rightarrow \mathcal{H}_2$ is Fredholm of index zero; therefore, we have verified assumptions (1)–(4) of §3.4.1. The poles of $\mathcal{R}(\omega) = \mathcal{P}(\omega)^{-1}$ coincide with the poles of the meromorphic continuation of the Schwartz kernel of the resolvent

$$R_g(\omega) := (h^2(\Delta_g - (n-1)^2/4) - \omega^2)^{-1} : L^2(M) \rightarrow L^2(M), \quad \text{Im } \omega > 0,$$

to the entire \mathbb{C} , first constructed in [87] with improvements by [60] – see [127, Theorem 5.1].

We can now proceed similarly to §3.4.3, using that the regions $\{\tilde{x} > \varepsilon_0\}$ are geodesically convex for $\varepsilon_0 > 0$ small enough (see for instance [47, Lemma 7.1]). Fix small $\varepsilon_0 > 0$, take any intervals

$$[\alpha_0, \alpha_1] \Subset [\beta_0, \beta_1] \Subset [\beta'_0, \beta'_1] \subset \Omega \cap (0, \infty),$$

and define

$$\mathcal{U}' := \{\tilde{x} > \varepsilon_0/2, |\xi|_g \in (\beta'_0, \beta'_1)\}, \quad \mathcal{U} := \{\tilde{x} > \varepsilon_0, |\xi|_g \in (\beta_0, \beta_1)\}. \quad (3.4.21)$$

As in §3.4.3, assumptions (5)–(9) hold, with

$$p(x, \xi) = |\xi|_g. \quad (3.4.22)$$

The operators P and $\mathcal{S}(\omega)$ constructed in Lemma 3.4.3 are given microlocally near \mathcal{U} by

$$P = \sqrt{h^2 \Delta_g - (n-1)^2/4}, \quad S(\omega) = \sqrt{\sqrt{h^2 \Delta_g - (n-1)^2/4} + \omega},$$

with the square roots defined as in (3.4.18).

Finally, for assumptions (10) and (11), take $\mathcal{Q} \in \Psi^{\text{comp}}(X)$ with $\text{WF}_h(\mathcal{Q}) \subset \mathcal{U}$ and

$$\sigma(\mathcal{Q}) \geq 0 \quad \text{everywhere}; \quad \sigma(\mathcal{Q}) > 0 \quad \text{on } p^{-1}([\alpha_0, \alpha_1]) \cap \{\tilde{x} \geq 2\varepsilon_0\}.$$

Then assumption (10) follows from [127, Theorem 4.8]. To verify assumption (11), we modify the proof of [127, Theorem 4.9] as follows: assume that $f = f(h) \in \mathcal{H}_2$ has norm bounded polynomially in h and put $u = \mathcal{R}'(\omega)f$, for $\omega = \omega(h)$ satisfying (3.4.1). Assume also that $\text{WF}_h(f) \subset \mathcal{U}'$ and take $\rho' \in \text{WF}_h(u) \cap \mathcal{U}'$. We may assume that $P_2(\omega)$ is not elliptic at ρ' , since otherwise $\rho' \in \text{WF}_h(f)$. If $\gamma(t)$ is the bicharacteristic of $\sigma(P_2(\omega))$ starting at ρ' , then (see [127, (3.32) and the end of §3.5]) either $\gamma(t)$ converges to the set $L_+ \subset \partial \overline{T^*X} \cap \{\mu = 0\}$ of radial points as $t \rightarrow -\infty$, or \mathcal{Q} is elliptic at $\gamma(-t_0)$ for some $t_0 > 0$. In the first case, $\gamma(-t_0) \notin \text{WF}_h(u)$ for $t_0 > 0$ large enough by the radial points argument [127, Proposition 4.5]; in the second case, by Proposition 3.3.2 we see that if $\gamma(-t_0) \in \text{WF}_h(u)$, then $\gamma(-t_0) \in \text{WF}_h(f)$. Combining this with Proposition 3.3.4, we see that there exists $t_1 \geq 0$ such that $\gamma(-t_1) \in \text{WF}_h(f)$. Since $\gamma(0), \gamma(-t_1) \in \mathcal{U}'$, and \mathcal{U}' is convex with respect to the bicharacteristic flow of $\sigma(P_2(\omega))$ (the latter being just a rescaling of the geodesic flow pulled back by a certain diffeomorphism), we see that $\gamma([-t_1, 0]) \subset \mathcal{U}'$. Now, by (3.4.20), $\gamma([-t_1, 0])$ is a flow line of H_{p^2} ; therefore, for some $t \geq 0$, $e^{-tH_p}(\rho') \in \text{WF}_h(f)$, as required.

3.5 r -normally hyperbolic trapped sets

In this section, we state the dynamical assumptions on the flow near the trapped set K , namely r -normal hyperbolicity, and define the expansion rates ν_{\min}, ν_{\max} (§3.5.1). We next establish some properties of r -normally hyperbolic trapped sets: existence of special defining functions φ_{\pm} of the incoming/outgoing tails Γ_{\pm} near K (§3.5.3), existence of the canonical projections π_{\pm} from open subsets $\Gamma_{\pm}^{\circ} \subset \Gamma_{\pm}$ to K and the canonical relation Λ° (§3.5.4), and regularity of solutions to the transport equations (§3.5.5).

3.5.1 Dynamical assumptions

Let $\mathcal{U} \subset \mathcal{U}'$ be the open sets from §3.4.1, and $p \in C^{\infty}(\mathcal{U}'; \mathbb{R})$ be the function defined in (3.4.4). Consider also the incoming/outgoing tails $\Gamma_{\pm} \subset \overline{\mathcal{U}}$ and the trapped set $K = \Gamma_+ \cap \Gamma_-$ defined in (3.4.5). We assume that, for a large fixed integer r depending only on the dimension n (see Figure 3.4(a)),

- (1) Γ_{\pm} are equal to the intersections of $\overline{\mathcal{U}}$ with codimension 1 orientable C^r submanifolds of T^*X ;

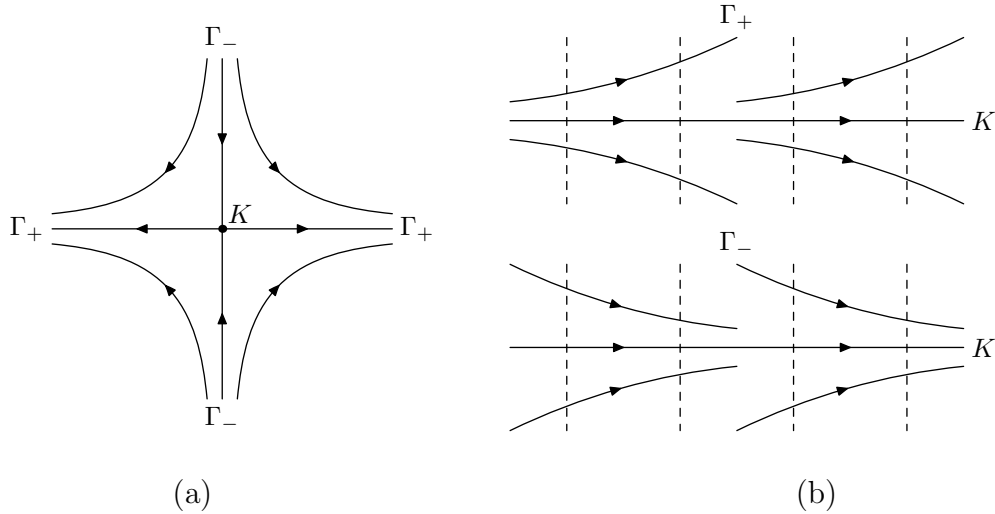

Figure 3.4: (a) Dynamics of e^{tH_p} in the directions transverse to the trapped set. (b) Dynamics on Γ_{\pm} ; the flow lines of \mathcal{V}_{\pm} are dashed.

- (2) Γ_+ and Γ_- intersect transversely, and the symplectic form σ_S is nondegenerate on TK ; that is, K extends to a symplectic submanifold of T^*X of codimension two.

Consider one-dimensional subbundles $\mathcal{V}_{\pm} \subset T\Gamma_{\pm}$ defined as the symplectic complements of $T\Gamma_{\pm}$ in $T_{\Gamma_{\pm}}(T^*X)$ (see Figure 3.4(b)); they are invariant under the flow e^{tH_p} . By assumption (2), we have $T_K\Gamma_{\pm} = \mathcal{V}_{\pm}|_K \oplus TK$. Define the minimal expansion rate in the normal direction, ν_{\min} , as the supremum of all ν for which there exists a constant C such that

$$\sup_{\rho \in K} \|de^{\mp tH_p}(\rho)|_{\mathcal{V}_{\pm}}\| \leq Ce^{-\nu t}, \quad t > 0. \quad (3.5.1)$$

Here $\|\cdot\|$ denotes the operator norm with respect to any smooth inner product on the fibers of $T(T^*X)$. Similarly we define the maximal expansion rate in the normal direction, ν_{\max} , as the infimum of all ν for which there exists a constant $c > 0$ such that

$$\inf_{\rho \in K} \|de^{\mp tH_p}(\rho)|_{\mathcal{V}_{\pm}}\| \geq ce^{-\nu t}, \quad t > 0. \quad (3.5.2)$$

Since e^{tH_p} preserves the symplectic form σ_S , which is nondegenerate on $\mathcal{V}_+|_K \oplus \mathcal{V}_-|_K$, it is enough to require (3.5.1) and (3.5.2) for a specific choice of sign.

We assume r -normal hyperbolicity:

- (3) Let μ_{\max} be the maximal expansion rate of the flow along K , defined as the infimum of all μ for which there exists a constant C such that

$$\sup_{\rho \in K} \|de^{tH_p}(\rho)|_{TK}\| \leq Ce^{\mu|t|}, \quad t \in \mathbb{R}. \quad (3.5.3)$$

Then

$$\nu_{\min} > r\mu_{\max}. \quad (3.5.4)$$

Assumption (3), rather than a weaker assumption of *normal hyperbolicity* $\nu_{\min} > 0$, is needed for regularity of solutions to the transport equations, see Lemma 3.5.2 below. The number r depends on how many derivatives of the symbols constructed below are needed for the semiclassical arguments to work. In the proofs, we will often take $r = \infty$, keeping in mind that a large fixed r is always enough.

3.5.2 Stability

We now briefly discuss stability of our dynamical assumptions under perturbations; more details, with applications to general relativity, are given in §4.3.6. Assume that p_s , where $s \in \mathbb{R}$ varies in a neighborhood of zero, is a family of real-valued functions on \mathcal{U}' such that $p_0 = p$ and p_s is continuous at $s = 0$ with values in $C^\infty(\mathcal{U}')$. Assume moreover that conditions (8) and (9) of §3.4.1 are satisfied with p replaced by any p_s . Here Γ_\pm and K are replaced by the sets $\Gamma_\pm(s)$ and $K(s)$ defined using p_s instead of p . We claim that assumptions (1)–(3) of §3.5.1 are satisfied for $p_s, \Gamma_\pm(s), K(s)$ when s is small enough.

We use the work of Hirsch–Pugh–Shub [64] on stability of r -normally hyperbolic invariant manifolds. Assumptions (1)–(3) imply that the flow e^{tH_p} is eventually absolutely r -normally hyperbolic on K in the sense of [64, Definition 4]. Then by [64, Theorem 4.1], for s small enough, $\Gamma_\pm(s)$ and $K(s)$ are C^r submanifolds of T^*X , which converge to Γ_\pm and K in C^r as $s \rightarrow 0$. It follows immediately that conditions (1) and (2) are satisfied for small s .

To see that condition (3) is satisfied for small s , as well as stability of the pinching condition (3.1.7) under perturbations, it suffices to show that, with $\nu_{\min}(s), \nu_{\max}(s), \mu_{\max}(s)$ defined using $e^{tH_{p_s}}, \Gamma_\pm(s), K(s)$,

$$\liminf_{s \rightarrow 0} \nu_{\min}(s) \geq \nu_{\min}, \quad (3.5.5)$$

$$\limsup_{s \rightarrow 0} \nu_{\max}(s) \leq \nu_{\max}, \quad (3.5.6)$$

$$\limsup_{s \rightarrow 0} \mu_{\max}(s) \leq \mu_{\max}. \quad (3.5.7)$$

We show (3.5.5); the other two inequalities are proved similarly. Fix a smooth metric on the fibers of $T(T^*X)$. Take arbitrary $\varepsilon > 0$, then for $T > 0$ large enough, we have

$$\sup_{\rho \in K} \|de^{\mp TH_p}(\rho)|_{\mathcal{V}_\pm}\| \leq e^{-(\nu_{\min} - \varepsilon)T}.$$

Fix T ; since $p_s, \Gamma_\pm(s), K(s)$, and the corresponding subbundles $\mathcal{V}_\pm(s)$ depend continuously on s at $s = 0$, we have for s small enough,

$$\sup_{\rho \in K(s)} \|de^{\mp TH_{p_s}}(\rho)|_{\mathcal{V}_\pm(s)}\| \leq e^{-(\nu_{\min} - \varepsilon/2)T}.$$

Since $e^{tH_{p_s}}$ is a one-parameter group of diffeomorphisms, we get

$$\sup_{\rho \in K(s)} \|de^{\mp tH_{p_s}}(\rho)|_{\mathcal{V}_\pm(s)}\| \leq C e^{-(\nu_{\min} - \varepsilon/2)t}, \quad t \geq 0;$$

therefore, $\nu_{\min}(s) \geq \nu_{\min} - \varepsilon/2$ for s small enough and (3.5.5) follows.

3.5.3 Adapted defining functions

In this section, we construct special defining functions φ_{\pm} of Γ_{\pm} near K . We will assume below that Γ_{\pm} are smooth; however, if Γ_{\pm} are C^r with $r \geq 1$, we can still obtain $\varphi_{\pm} \in C^r$. A similar construction can be found in [132, Lemma 4.1].

Lemma 3.5.1. *Fix $\varepsilon > 0$.³ Then there exist smooth functions φ_{\pm} , defined in a neighborhood of K in \mathcal{U}' , such that for $\delta > 0$ small enough, the set*

$$U_{\delta} := \overline{\mathcal{U}} \cap \{|\varphi_{+}| \leq \delta, |\varphi_{-}| \leq \delta\}, \quad (3.5.8)$$

is a compact subset of \mathcal{U} when intersected with $p^{-1}([\alpha_0, \alpha_1])$, and:

- (1) $\Gamma_{\pm} \cap U_{\delta} = \{\varphi_{\pm} = 0\} \cap U_{\delta}$, and $d\varphi_{\pm} \neq 0$ on U_{δ} ;
- (2) $H_p\varphi_{\pm} = \mp c_{\pm}\varphi_{\pm}$ on U_{δ} , where c_{\pm} are smooth functions on U_{δ} and, with ν_{\min}, ν_{\max} defined in (3.5.1), (3.5.2),

$$\nu_{\min} - \varepsilon < c_{\pm} < \nu_{\max} + \varepsilon \quad \text{on } U_{\delta}; \quad (3.5.9)$$

- (3) the Hamiltonian field $H_{\varphi_{\pm}}$ spans the subbundle \mathcal{V}_{\pm} on $\Gamma_{\pm} \cap U_{\delta}$ defined before (3.5.1);
- (4) $\{\varphi_{+}, \varphi_{-}\} > 0$ on U_{δ} ;
- (5) U_{δ} is convex, namely if $\gamma(t)$, $0 \leq t \leq T$, is a Hamiltonian flow line of p in $\overline{\mathcal{U}}$ and $\gamma(0), \gamma(T) \in U_{\delta}$, then $\gamma([0, T]) \subset U_{\delta}$.

Proof. Since Γ_{\pm} are orientable, there exist defining functions $\tilde{\varphi}_{\pm}$ of Γ_{\pm} near K ; that is, $\tilde{\varphi}_{\pm}$ are smooth, defined in some neighborhood U of K , and $d\tilde{\varphi}_{\pm} \neq 0$ on U and $\Gamma_{\pm} \cap U = \overline{\mathcal{U}} \cap \{\tilde{\varphi}_{\pm} = 0\}$. Since K is symplectic, by changing the sign of $\tilde{\varphi}_{-}$ if necessary, we can moreover assume that $\{\tilde{\varphi}_{+}, \tilde{\varphi}_{-}\} > 0$ on K .

Since $e^{tH_p}(\Gamma_{\pm}) \subset \Gamma_{\pm}$ for $\mp t \geq 0$, we have $H_p\tilde{\varphi}_{\pm} = 0$ on Γ_{\pm} ; therefore,

$$H_p\tilde{\varphi}_{\pm} = \mp \tilde{c}_{\pm}\tilde{\varphi}_{\pm},$$

where \tilde{c}_{\pm} are smooth functions on U . The functions \tilde{c}_{\pm} control how fast $\tilde{\varphi}_{\pm}$ decays along the flow as $t \rightarrow \pm\infty$. The constants ν_{\min} and ν_{\max} control the average decay rate; to construct φ_{\pm} , we will modify $\tilde{\varphi}_{\pm}$ by averaging along the flow for a large time.

For any $\rho \in \Gamma_{\pm} \cap U$, the kernel of $d\tilde{\varphi}_{\pm}(\rho)$ is equal to $T_{\rho}\Gamma_{\pm}$; therefore, the Hamiltonian fields $H_{\tilde{\varphi}_{\pm}}$ span \mathcal{V}_{\pm} on $\Gamma_{\pm} \cap U$. We then see from the definitions (3.5.1), (3.5.2) of ν_{\min}, ν_{\max} that there exists a constant C such that, with $(e^{\mp tH_p})_*H_{\tilde{\varphi}_{\pm}} \in \mathcal{V}_{\pm}$ denoting the push-forward of the vector field $H_{\tilde{\varphi}_{\pm}}$ by the diffeomorphism $e^{\mp tH_p}$,

$$C^{-1}e^{-(\nu_{\max}+\varepsilon/2)t} \leq \frac{(e^{\mp tH_p})_*H_{\tilde{\varphi}_{\pm}}}{H_{\tilde{\varphi}_{\pm}}} \leq Ce^{-(\nu_{\min}-\varepsilon/2)t} \quad \text{on } K, \quad t \geq 0.$$

³The parameter ε is fixed in Theorem 3.1; it is also taken small enough for the results of §3.5.5 to hold.

Now, we calculate on K ,

$$\begin{aligned} \partial_t((e^{\mp t H_p})_* H_{\tilde{\varphi}_{\pm}}) &= \pm (e^{\mp t H_p})_* [H_p, H_{\tilde{\varphi}_{\pm}}] \\ &= -(e^{\mp t H_p})_* H_{\tilde{c}_{\pm} \tilde{\varphi}_{\pm}} = -(\tilde{c}_{\pm} \circ e^{\pm t H_p})(e^{\mp t H_p})_* H_{\tilde{\varphi}_{\pm}}. \end{aligned}$$

Combining these two facts, we get for $T > 0$ large enough,

$$\nu_{\min} - \varepsilon < \langle \tilde{c}_{\pm} \rangle_T < \nu_{\max} + \varepsilon \quad \text{on } K,$$

where $\langle \cdot \rangle_T$ stands for the ergodic average on K :

$$\langle f \rangle_T := \frac{1}{T} \int_0^T f \circ e^{t H_p} dt.$$

Fix T . We now put $\varphi_{\pm} := e^{\mp t H_p} \cdot \tilde{\varphi}_{\pm}$, where f_{\pm} are smooth functions on U with

$$f_{\pm} = \frac{1}{T} \int_0^T (T-t) \tilde{c}_{\pm} \circ e^{t H_p} dt \quad \text{on } K,$$

so that $H_p f_{\pm} = \langle \tilde{c}_{\pm} \rangle_T - \tilde{c}_{\pm}$ on K . Then φ_{\pm} satisfy conditions (1)–(4), with

$$c_{\pm} = \mp \frac{H_p \varphi_{\pm}}{\varphi_{\pm}} = \langle \tilde{c}_{\pm} \rangle_T \in (\nu_{\min} - \varepsilon, \nu_{\max} + \varepsilon)$$

on K , and thus on U_{δ} for δ small enough.

To verify condition (5), fix $\delta_0 > 0$ small enough so that $\pm H_p \varphi_{\pm}^2 \leq 0$ on U_{δ_0} . By Lemma 3.4.2, for δ small enough depending on δ_0 , for each Hamiltonian flow line $\gamma(t)$, $0 \leq t \leq T$, of p in $\bar{\mathcal{U}}$, if $\gamma(0), \gamma(T) \in U_{\delta}$, then $\gamma([0, T]) \subset U_{\delta_0}$. Since $\pm \partial_t \varphi_{\pm}(\gamma(t))^2 \leq 0$ for $0 \leq t \leq T$ and $|\varphi_{\pm}(\gamma(t))| \leq \delta$ for $t = 0, T$, we see that $\gamma([0, T]) \subset U_{\delta}$. \square

3.5.4 The canonical relation Λ°

We next construct the projections π_{\pm} from subsets $\Gamma_{\pm}^{\circ} \subset \Gamma_{\pm}$ to K . Fix $\delta_0, \delta_1 > 0$ small enough so that Lemma 3.5.1 holds with δ_0 in place of δ and $K \cap p^{-1}([\alpha_0 - \delta_1, \alpha_1 + \delta_1])$ is a compact subset of \mathcal{U} (the latter is possible by assumption (9) in §3.4.1), consider the functions φ_{\pm} from Lemma 3.5.1 and put

$$\Gamma_{\pm}^{\circ} := \Gamma_{\pm} \cap p^{-1}(\alpha_0 - \delta_1, \alpha_1 + \delta_1) \cap \{|\varphi_{\mp}| < \delta_0\}, \quad K^{\circ} := K \cap p^{-1}(\alpha_0 - \delta_1, \alpha_1 + \delta_1), \quad (3.5.10)$$

so that $K^{\circ} = \Gamma_+^{\circ} \cap \Gamma_-^{\circ}$ and, for δ_0 small enough, $\Gamma_{\pm}^{\circ} \subset \mathcal{U}$. Note that, by part (2) of Lemma 3.5.1, the level sets of p on Γ_{\pm} are invariant under $H_{\varphi_{\pm}}$ and $e^{t H_p}(\Gamma_{\pm}^{\circ}) \subset \Gamma_{\pm}^{\circ}$ for $\mp t \geq 0$.

By part (4) of Lemma 3.5.1, Γ_{\pm}° is foliated by trajectories of $H_{\varphi_{\pm}}$ (or equivalently, by trajectories of \mathcal{V}_{\pm}), moreover each trajectory intersects K at a single point. This defines projection maps

$$\pi_{\pm} : \Gamma_{\pm}^{\circ} \rightarrow K^{\circ},$$

mapping each trajectory to its intersection with K . The flow e^{tH_p} preserves the subbundle \mathcal{V}_\pm generated by H_{φ_\pm} , therefore

$$\pi_\pm \circ e^{\mp tH_p} = e^{\mp tH_p} \circ \pi_\pm, \quad t \geq 0. \quad (3.5.11)$$

Now, define the $2n$ -dimensional submanifold $\Lambda^\circ \subset T^*X \times T^*X$ by

$$\Lambda^\circ := \{(\rho_-, \rho_+) \in \Gamma_-^\circ \times \Gamma_+^\circ \mid \pi_-(\rho_-) = \pi_+(\rho_+)\}. \quad (3.5.12)$$

We claim that Λ° is a canonical relation. Indeed, it is enough to prove that $\sigma_S|_{T\Gamma_\pm^\circ} = \pi_\pm^*(\sigma_S|_{TK^\circ})$, where σ_S is the symplectic form on T^*M . This is true since the Hamiltonian flow $e^{tH_{\varphi_\pm}}$ preserves σ_S and $\mathcal{V}_\pm|_K$ is symplectically orthogonal to TK .

3.5.5 The transport equations

Finally, we use r -normal hyperbolicity to establish existence of solutions to the transport equations, needed in the construction of the projector Π in §3.7.1. We start by estimating higher derivatives of the flow. Take $\delta_0, \Gamma_\pm^\circ, K^\circ$ from §3.5.4 and identify $\Gamma_\pm^\circ \sim K^\circ \times (-\delta_0, \delta_0)$ by the map

$$\rho_\pm \in \Gamma_\pm^\circ \mapsto (\pi_\pm(\rho_\pm), \varphi_\mp(\rho_\pm)). \quad (3.5.13)$$

Denote elements of $K^\circ \times (-\delta_0, \delta_0)$ by (θ, s) and the flow e^{tH_p} on Γ_\pm° , $\mp t \geq 0$, by (recall (3.5.11))

$$e^{tH_p} : (\theta, s) \mapsto (e^{tH_p}(\theta), \psi_\pm^t(\theta, s)).$$

Note that $\psi_\pm^t(\theta, 0) = 0$. We have the following estimate on higher derivatives of the flow on K° (in any fixed coordinate system), see for example [47, Lemma C.1] (which is stated for geodesic flows, but the proof applies to any smooth flow):

$$\sup_{\theta \in K^\circ} |\partial_\theta^\alpha e^{tH_p}(\theta)| \leq C_\alpha e^{(|\alpha| \mu_{\max} + \tilde{\varepsilon})|t|}, \quad t \in \mathbb{R}. \quad (3.5.14)$$

Here μ_{\max} is defined by (3.5.3), $\tilde{\varepsilon} > 0$ is any fixed constant, and C_α depends on $\tilde{\varepsilon}$. We choose $\tilde{\varepsilon}$ small enough in (3.5.17) below and the constant $\varepsilon > 0$ in Lemma 3.5.1 is small depending on $\tilde{\varepsilon}$.

Next, we estimate the derivatives of ψ_\pm^t . We have, with c_\pm defined in part (2) of Lemma 3.5.1,

$$\partial_t \psi_\pm^t(\theta, s) = \pm c_\mp (e^{tH_p}(\theta), \psi_\pm^t(\theta, s)) \psi_\pm^t(\theta, s).$$

Then

$$\partial_t (\partial_s^k \partial_\theta^\alpha \psi_\pm^t(\theta, s)) = \pm c_\mp (e^{tH_p}(\theta), 0) \partial_s^k \partial_\theta^\alpha \psi_\pm^t(\theta, s) + \dots,$$

where \dots is a linear combination, with uniformly bounded variable coefficients depending on the derivatives of c_\mp , of expressions of the form

$$\partial_\theta^{\beta_1} e^{tH_p}(\theta) \dots \partial_\theta^{\beta_m} e^{tH_p}(\theta) \partial_\theta^{\gamma_1} \partial_s^{k_1} \psi_\pm^t(\theta, s) \dots \partial_\theta^{\gamma_l} \partial_s^{k_l} \psi_\pm^t(\theta, s),$$

where $\beta_1 + \dots + \beta_m + \gamma_1 + \dots + \gamma_l = \alpha$, $k_1 + \dots + k_l = k$, and $|\beta_j|, |\gamma_j| + k_j > 0$. Moreover, if $l = 0$ or $l + m = 1$, then the corresponding coefficient is a bounded multiple of $\psi_{\pm}^t(\theta, s)$. It now follows by induction from (3.5.9) that

$$\sup_{\theta \in K^\circ, |s| < \delta_0} |\partial_s^k \partial_\theta^\alpha \psi_{\pm}^{\mp t}(\theta, s)| \leq C_{\alpha k} e^{(|\alpha| \mu_{\max} - \nu_{\min} + \tilde{\varepsilon})t}, \quad t \geq 0. \quad (3.5.15)$$

We can now prove the following

Lemma 3.5.2. *Assume that (3.5.4) is satisfied, with some integer $r > 0$. Let $f \in C^{r+1}(\Gamma_{\pm}^\circ)$ be such that $f|_K = 0$. Then there exists unique solution $a \in C^r(\Gamma_{\pm}^\circ)$ to the equation*

$$H_p a = f, \quad a|_{K^\circ} = 0. \quad (3.5.16)$$

Proof. Using (3.5.4), choose $\tilde{\varepsilon} > 0$ so that

$$r\mu_{\max} - \nu_{\min} + \tilde{\varepsilon} < 0. \quad (3.5.17)$$

Any solution to (3.5.16) satisfies for each $T > 0$,

$$a = a \circ e^{\mp TH_p} \pm \int_0^T f \circ e^{\mp t H_p} dt.$$

Since $a|_{K^\circ} = 0$, by letting $T \rightarrow +\infty$ we see that the unique solution to (3.5.16) is

$$a = \pm \int_0^\infty f \circ e^{\mp t H_p} dt. \quad (3.5.18)$$

The integral (3.5.18) converges exponentially, as

$$|f \circ e^{\mp t H_p}(\theta, s)| \leq C |\psi_{\pm}^{\mp t}(\theta, s)| \leq C e^{-(\nu_{\min} - \varepsilon)t}.$$

To show that $a \in C^r$, it suffices to prove that when $|\alpha| + k \leq r$, the integral

$$\int_0^\infty \partial_s^k \partial_\theta^\alpha (f \circ e^{\mp t H_p}) dt$$

converges uniformly in s, θ . Given (3.5.17), it is enough to show that

$$\sup_{\theta, s} |\partial_s^k \partial_\theta^\alpha (f \circ e^{\mp t H_p})(\theta, s)| \leq C_{\alpha k} e^{(|\alpha| \mu_{\max} - \nu_{\min} + \tilde{\varepsilon})t}, \quad t > 0. \quad (3.5.19)$$

To see (3.5.19), we use the chain rule to estimate the left-hand side by a sum of terms of the form

$$\partial_\theta^m \partial_s^l f(e^{\mp t H_p}(\theta, s)) \partial_\theta^{\beta_1} e^{\mp t H_p}(\theta) \dots \partial_\theta^{\beta_m} e^{\mp t H_p}(\theta) \partial_\theta^{\gamma_1} \partial_s^{k_1} \psi_{\pm}^{\mp t}(\theta, s) \dots \partial_\theta^{\gamma_l} \partial_s^{k_l} \psi_{\pm}^{\mp t}(\theta, s)$$

where $\beta_1 + \dots + \beta_m + \gamma_1 + \dots + \gamma_l = \alpha$, $k_1 + \dots + k_l = k$, and $|\beta_j|, |\gamma_j| + k_j > 0$. For $l = 0$, we have $|\partial_\theta^m f \circ e^{\mp t H_p}| = \mathcal{O}(e^{-(\nu_{\min} - \varepsilon)t})$ and (3.5.19) follows from (3.5.14). For $l > 0$, (3.5.19) follows from (3.5.14) and (3.5.15). \square

3.6 Calculus of microlocal projectors

In this section, we develop tools for handling Fourier integral operators associated to the canonical relation Λ° introduced in §3.5.4. We will not use the operator P or the global dynamics of the flow e^{tH_p} ; we will only assume that X is an n -dimensional manifold and

- $\Gamma_\pm^\circ \subset T^*X$ are smooth orientable hypersurfaces;
- Γ_\pm° intersect transversely and $K^\circ := \Gamma_+^\circ \cap \Gamma_-^\circ$ is symplectic;
- if $\mathcal{V}_\pm \subset T\Gamma_\pm^\circ$ is the symplectic complement of $T\Gamma_\pm^\circ$ in $T(T^*X)$, then each maximally extended flow line of \mathcal{V}_\pm on Γ_\pm° intersects K° at precisely one point, giving rise to the projection maps $\pi_\pm : \Gamma_\pm^\circ \rightarrow K^\circ$;
- the canonical relation $\Lambda^\circ \subset T^*(X \times X)$ is defined by

$$\Lambda^\circ = \{(\rho_-, \rho_+) \in \Gamma_-^\circ \times \Gamma_+^\circ \mid \pi_-(\rho_-) = \pi_+(\rho_+)\};$$

- the projections $\tilde{\pi}_\pm : \Lambda^\circ \rightarrow \Gamma_\pm^\circ$ are defined by

$$\tilde{\pi}_\pm(\rho_-, \rho_+) = \rho_\pm. \tag{3.6.1}$$

If we only consider a bounded number of terms in the asymptotic expansions of the studied symbols, and require existence of a fixed number of derivatives of these symbols, then the smoothness requirement above can be replaced by C^r for r large enough depending only on n .

We will study the operators in the class $I_{\text{comp}}(\Lambda^\circ)$ considered in §3.3.2. The antiderivative on Λ° (see §3.3.2) is fixed so that it vanishes on the image of the embedding

$$j_K : K^\circ \rightarrow \Lambda^\circ, \quad j_K(\rho) = (\rho, \rho); \tag{3.6.2}$$

this is possible since $j_K^*(\eta dy - \xi dx) = 0$ and the image of j_K is a deformation retract of Λ° .

We are particularly interested in defining invariantly the principal symbol $\sigma_\Lambda(A)$ of an operator $A \in I_{\text{comp}}(\Lambda^\circ)$. This could be done using the global theory of Fourier integral operators; we take instead a more direct approach based on the model case studied in §3.6.1. The principal symbols on a neighborhood $\tilde{\Lambda}$ of a compact subset $\hat{K} \subset K^\circ$ are defined as sections of certain vector bundles in §3.6.2.

We are also interested in the symbol of a product of two operators in $I_{\text{comp}}(\Lambda^\circ)$. Note that such a product lies again in $I_{\text{comp}}(\Lambda^\circ)$, since Λ° satisfies the transversality condition with itself and, with the composition defined as in (3.3.5), $\Lambda^\circ \circ \Lambda^\circ = \Lambda^\circ$. To study the principal symbol of the product, we again use the model case – see Proposition 3.6.5.

Next, in §3.6.3, we study idempotents in $I_{\text{comp}}(\Lambda^\circ)$, microlocally near \hat{K} , proving technical lemmas need in the construction of the microlocal projector Π in §3.7. Finally, in §3.6.4, we consider left and right ideals of pseudodifferential operators annihilating a microlocal idempotent, which are key for proving resolvent estimates in §3.8.

3.6.1 Model case

We start with the model case

$$X := \mathbb{R}^n, \quad \Gamma_+^0 := \{\xi_n = 0\}, \quad \Gamma_-^0 := \{x_n = 0\}. \quad (3.6.3)$$

Then $K^0 = \{x_n = \xi_n = 0\}$ is canonically diffeomorphic to $T^*\mathbb{R}^{n-1}$. If we denote elements of $\mathbb{R}^{2n} \simeq T^*\mathbb{R}^n$ by (x', x_n, ξ', ξ_n) , with $x', \xi' \in \mathbb{R}^{n-1}$, then the projection maps $\pi_\pm : \Gamma_\pm^0 \rightarrow K^0$ take the form

$$\pi_+(x, \xi', 0) = (x', 0, \xi', 0), \quad \pi_-(x', 0, \xi) = (x', 0, \xi', 0),$$

and the map

$$\phi : (x, \xi) \mapsto (x', 0, \xi; x, \xi', 0) \in T^*(\mathbb{R}^n \times \mathbb{R}^n) \quad (3.6.4)$$

gives a diffeomorphism of \mathbb{R}^{2n} onto the corresponding canonical relation Λ^0 .

Basic calculus. For a Schwartz function $a(x, \xi) \in \mathcal{S}(\mathbb{R}^{2n})$, define its Λ^0 -quantization $\text{Op}_h^\Lambda(a) : \mathcal{S}'(\mathbb{R}^n) \rightarrow \mathcal{S}'(\mathbb{R}^n)$ by the formula

$$\text{Op}_h^\Lambda(a)u(x) = (2\pi h)^{-n} \int_{\mathbb{R}^{2n}} e^{\frac{i}{h}(x' \cdot \xi' - y \cdot \xi)} a(x, \xi) u(y) dy d\xi. \quad (3.6.5)$$

The operator $\text{Op}_h^\Lambda(a)$ will be a Fourier integral operator associated to Λ^0 , see below for details. We also use the standard quantization for pseudodifferential operators [137, §4.1.1], where $a(x, \xi; h) \in C^\infty(\mathbb{R}^{2n})$ and all derivatives of a are bounded uniformly in h by a fixed power of $1 + |x|^2 + |\xi|^2$:

$$\text{Op}_h(a)u(x) = (2\pi h)^{-n} \int_{\mathbb{R}^{2n}} e^{\frac{i}{h}(x-y) \cdot \xi} a(x, \xi) u(y) dy d\xi. \quad (3.6.6)$$

The symbol a can be extracted from $\text{Op}_h^\Lambda(a)$ or $\text{Op}_h(a)$ by the following oscillatory testing formulas, see [137, Theorem 4.19]:

$$\text{Op}_h^\Lambda(a)(e^{\frac{i}{h}x \cdot \xi}) = e^{\frac{i}{h}x' \cdot \xi'} a(x, \xi), \quad \xi \in \mathbb{R}^n, \quad (3.6.7)$$

$$\text{Op}_h(a)(e^{\frac{i}{h}x \cdot \xi}) = e^{\frac{i}{h}x \cdot \xi} a(x, \xi), \quad \xi \in \mathbb{R}^n. \quad (3.6.8)$$

From here, using stationary phase expansions similarly to [137, Theorems 4.11 and 4.12], we get (where the symbols quantized by Op_h^Λ are Schwartz)

$$\text{Op}_h^\Lambda(a) \text{Op}_h^\Lambda(b) = \text{Op}_h^\Lambda(a \#^\Lambda b), \quad (3.6.9)$$

$$\text{Op}_h^\Lambda(a) \text{Op}_h(b) = \text{Op}_h^\Lambda(a \# b), \quad (3.6.10)$$

$$\text{Op}_h(b) \text{Op}_h^\Lambda(a) = \text{Op}_h^\Lambda(a \#_b), \quad (3.6.11)$$

where the symbols $a\#\Lambda b, a_{\#b}, a_{b\#} \in \mathcal{S}(\mathbb{R}^{2n})$ have asymptotic expansions

$$a\#\Lambda b(x, \xi) \sim \sum_{\alpha} \frac{(-ih)^{|\alpha|}}{\alpha!} \partial_{\xi}^{\alpha} a(x, \xi', 0) \partial_x^{\alpha} b(x', 0, \xi), \quad (3.6.12)$$

$$a_{\#b}(x, \xi) \sim \sum_{\alpha} \frac{(-ih)^{|\alpha|}}{\alpha!} \partial_{\xi}^{\alpha} a(x, \xi) \partial_x^{\alpha} b(x', 0, \xi), \quad (3.6.13)$$

$$a_{b\#}(x, \xi) \sim \sum_{\alpha} \frac{(-ih)^{|\alpha|}}{\alpha!} \partial_{\xi}^{\alpha} b(x, \xi', 0) \partial_x^{\alpha} a(x, \xi). \quad (3.6.14)$$

Finally, the operators $\text{Op}_h^{\Lambda}(a)$ are bounded $L^2 \rightarrow L^2$ with norm $\mathcal{O}(h^{-1/2})$:

Proposition 3.6.1. *If $a \in \mathcal{S}(\mathbb{R}^{2n})$, then there exists a constant C such that*

$$\|\text{Op}_h^{\Lambda}(a)\|_{L^2(\mathbb{R}^n) \rightarrow L^2(\mathbb{R}^n)} \leq Ch^{-1/2}.$$

Proof. Define the semiclassical Fourier transform

$$\hat{u}(\xi) := (2\pi h)^{-n/2} \int_{\mathbb{R}^n} e^{-\frac{i}{h} y \cdot \xi} u(y) dy,$$

then $\|\hat{u}\|_{L^2} = \|u\|_{L^2}$ and

$$\text{Op}_h^{\Lambda}(a)u(x) = (2\pi h)^{-1/2} \int_{\mathbb{R}} v(x, \xi_n) d\xi_n,$$

where

$$v(x, \xi_n) := (2\pi h)^{-(n-1)/2} \int_{\mathbb{R}^{n-1}} e^{\frac{i}{h} x' \cdot \xi'} a(x, \xi', \xi_n) \hat{u}(\xi', \xi_n) d\xi'.$$

Using the L^2 -boundedness of pseudodifferential operators on \mathbb{R}^{n-1} , we see that for each $(x_n, \xi_n) \in \mathbb{R}^2$,

$$\|v(\cdot, x_n, \xi_n)\|_{L_{x'}^2} \leq F(x_n, \xi_n) \|\hat{u}(\cdot, \xi_n)\|_{L_{\xi'}^2},$$

where $F(x_n, \xi_n)$ is bounded by a certain $\mathcal{S}(\mathbb{R}^{2n-2})$ seminorm of $a(\cdot, x_n, \cdot, \xi_n)$. Then F is rapidly decaying on \mathbb{R}^2 and for any N ,

$$\|v(\cdot, \xi_n)\|_{L_x^2} \leq C \langle \xi_n \rangle^{-N} \|\hat{u}(\cdot, \xi_n)\|_{L_{\xi'}^2}.$$

Therefore,

$$\|\text{Op}_h^{\Lambda}(a)u(x)\|_{L^2} \leq Ch^{-1/2} \int_{\mathbb{R}} \|v(\cdot, \xi_n)\|_{L_x^2} d\xi_n \leq Ch^{-1/2} \|u\|_{L^2}$$

as required. \square

Microlocal properties. For $a \in \mathcal{S}(\mathbb{R}^{2n})$, the operator $\text{Op}_h^\Lambda(a)$ is h -tempered as defined in Section 3.3.1. Moreover, the following analog of (3.3.4) follows from (3.6.10) and (3.6.11):

$$\text{WF}_h(\text{Op}_h^\Lambda(a)) \subset \phi(\text{supp } a) \subset \Lambda^0, \quad (3.6.15)$$

with ϕ defined by (3.6.4).

For $a \in C_0^\infty(\mathbb{R}^{2n})$, we use (3.3.3) to check that $\text{Op}_h^\Lambda(a)$ is, modulo an $\mathcal{O}(h^\infty)_{\mathcal{S}' \rightarrow \mathcal{S}}$ remainder, a Fourier integral operator in the class $I_{\text{comp}}(\Lambda^0)$ defined in §3.3.1.

We will also use the operator $\text{Op}_h^\Lambda(1) : C^\infty(\mathbb{R}^n) \rightarrow C^\infty(\mathbb{R}^n)$ defined by

$$\text{Op}_h^\Lambda(1)f(x) = f(x', 0), \quad f \in C^\infty(\mathbb{R}^n). \quad (3.6.16)$$

Since (3.6.5) was defined only for Schwartz symbols, we understand (3.6.16) as follows: if $a \in C_0^\infty(\mathbb{R}^{2n})$ is equal to 1 near some open set $U \subset \mathbb{R}^{2n}$, then the operator $\text{Op}_h^\Lambda(1)$ defined in (3.6.16) is equal to the operator $\text{Op}_h^\Lambda(a)$ defined in (3.6.5), microlocally near $\phi(U) \subset T^*(\mathbb{R}^n \times \mathbb{R}^n)$. Moreover, $\text{WF}_h(\text{Op}_h^\Lambda(1)) \cap T^*(\mathbb{R}^n \times \mathbb{R}^n) \subset \Lambda^0$. To see this, it is enough to note that for $a \in C_0^\infty(\mathbb{R}^{2n})$ and $\chi \in C_0^\infty(\mathbb{R}^n)$, we have $\chi \text{Op}_h^\Lambda(1) \text{Op}_h^\Lambda(a) = \text{Op}_h^\Lambda(\tilde{a})$, where $\tilde{a}(x, \xi) = \chi(x)a(x', 0, \xi) \in C_0^\infty(\mathbb{R}^{2n})$ and $\text{Op}_h^\Lambda(\tilde{a})$ is defined using (3.6.5).

Canonical transformations. We now study how $\text{Op}_h^\Lambda(a)$ changes under quantized canonical transformations preserving its canonical relation (see §3.3.2). Let $U, V \subset \mathbb{R}^{2n}$ be two bounded open sets and $\varkappa : U \rightarrow V$ a symplectomorphism such that

$$\varkappa(\Gamma_\pm^0 \cap U) = \Gamma_\pm^0 \cap V,$$

with Γ_\pm^0 given by (3.6.3). We further assume that for each $(x', \xi') \in T^*\mathbb{R}^{n-1}$, the sets $\{x_n \mid (x', x_n, \xi', 0) \in U\}$ and $\{\xi_n \mid (x', 0, \xi', \xi_n) \in U\}$, and the corresponding sets for V , are either empty or intervals containing zero, so that the maps $\pi_\pm : U \cap \Gamma_\pm^0 \rightarrow U \cap K^0$ are well-defined. Since \varkappa preserves the subbundles \mathcal{V}_\pm , it commutes with the maps π_\pm and thus preserves Λ^0 ; using the map ϕ from (3.6.4), we define the open sets $\widehat{U}, \widehat{V} \subset \mathbb{R}^{2n}$ and the diffeomorphism $\widehat{\varkappa} : \widehat{U} \rightarrow \widehat{V}$ by

$$\widehat{U} := \phi^{-1}(U \times U), \quad \widehat{V} := \phi^{-1}(V \times V), \quad \phi \circ \widehat{\varkappa} = \varkappa \circ \phi.$$

Proposition 3.6.2. *Let $B, B' : C^\infty(\mathbb{R}^n) \rightarrow C_0^\infty(\mathbb{R}^n)$ be two compactly microlocalized Fourier integral operators associated to \varkappa and \varkappa^{-1} , respectively,⁴ such that*

$$\begin{aligned} BB' &= 1 + \mathcal{O}(h^\infty) \quad \text{microlocally near } V', \\ B'B &= 1 + \mathcal{O}(h^\infty) \quad \text{microlocally near } U', \end{aligned} \quad (3.6.17)$$

for some open $U' \Subset U$, $V' \Subset V$ such that $\varkappa(U') = V'$. Then for each $a \in C_0^\infty(\widehat{V})$,

$$B' \text{Op}_h^\Lambda(a) B = \text{Op}_h^\Lambda(a_\varkappa) + \mathcal{O}(h^\infty)_{\mathcal{S}' \rightarrow \mathcal{S}},$$

⁴The choice of antiderivative (see §3.3.2) is irrelevant here, since the phase factor in B resulting from choosing another antiderivative will be cancelled by the phase factor in B' .

for some classical symbol a_\varkappa compactly supported in \widehat{U} , and

$$a_\varkappa(x, \xi) = \gamma_\varkappa^+(x, \xi') \gamma_\varkappa^-(x', \xi) a(\widehat{\varkappa}(x, \xi)) + \mathcal{O}(h) \quad \text{on } \phi^{-1}(U' \times U'), \quad (3.6.18)$$

where γ_\varkappa^\pm are smooth functions on $U \cap \Gamma_\pm$ depending on \varkappa, B, B' with $\gamma_\varkappa^\pm|_{K^0 \cap U'} = 1$.

Proof. Assume first that \varkappa has a generating function $S(x, \eta)$:

$$\varkappa(x, \xi) = (y, \eta) \iff \xi = \partial_x S(x, \eta), \quad y = \partial_\eta S(x, \eta).$$

If $\mathcal{D}_S \subset \mathbb{R}^{2n}$ is the domain of S , then for each $(x', \eta') \in T^*\mathbb{R}^{n-1}$, the sets $\{x_n \mid (x', x_n, \eta', 0) \in \mathcal{D}_S\}$ and $\{\eta_n \mid (x', 0, \eta', \eta_n) \in \mathcal{D}_S\}$ are either empty or intervals containing zero. Since \varkappa preserves Γ_\pm , we find $\partial_{\eta_n} S(x', 0, \eta) = \partial_{x_n} S(x, \eta', 0) = 0$ and thus

$$S(x, \eta', 0) = S(x', 0, \eta) = S(x', 0, \eta', 0). \quad (3.6.19)$$

We can write, modulo $\mathcal{O}(h^\infty)_{\mathcal{S}' \rightarrow \mathcal{S}}$ errors,

$$\begin{aligned} Bu(y) &= (2\pi h)^{-n} \int e^{\frac{i}{h}(y \cdot \eta - S(x, \eta))} b(x, \eta; h) u(x) dx d\eta, \\ B'u(x) &= (2\pi h)^{-n} \int e^{\frac{i}{h}(S(x, \eta) - y \cdot \eta)} b'(x, \eta; h) u(y) dy d\eta, \end{aligned}$$

where b, b' are compactly supported classical symbols and by (3.6.17) the principal symbols b_0 and b'_0 have to satisfy for $(x, \xi) \in U'$,

$$b_0(x, \eta) b'_0(x, \eta) = |\det \partial_{x\eta}^2 S(x, \eta)|. \quad (3.6.20)$$

We can now use oscillatory testing (3.6.7) to get

$$\begin{aligned} a_\varkappa(x, \xi) &:= e^{-\frac{i}{h} x' \cdot \xi'} B' \text{Op}_h^\Lambda(a) B(e^{\frac{i}{h} x \cdot \xi}) \\ &= (2\pi h)^{-2n} \int_{\mathbb{R}^{4n}} e^{\frac{i}{h} (-x' \cdot \xi' + S(x, \tilde{\eta}) - y \cdot \tilde{\eta} + y' \cdot \eta' - S(\tilde{x}, \tilde{\eta}) + \tilde{x} \cdot \xi)} b'(x, \tilde{\eta}; h) a(y, \eta) b(\tilde{x}, \tilde{\eta}; h) dy d\tilde{\eta} d\eta d\tilde{x}. \end{aligned}$$

We analyse this integral by the method of stationary phase; this will yield that a_\varkappa is a classical symbol in h , compactly supported in \widehat{U} modulo an $\mathcal{O}(h^\infty)_{\mathcal{S}(\mathbb{R}^{2n})}$ error, and thus $B' \text{Op}_h^\Lambda(a) B = \text{Op}_h^\Lambda(a_\varkappa)$.

The stationary points are given by

$$\tilde{\eta} = (\eta', 0), \quad \tilde{x} = (x', 0), \quad (y, \eta) = \widehat{\varkappa}(x, \xi).$$

The value of the phase at stationary points is zero due to (3.6.19). To compute the Hessian, we make the change of variables $\tilde{\eta} = \tilde{\eta} + (\eta', 0)$. We can then remove the variables $y, \tilde{\eta}$ and pass from the original Hessian to $\partial_{\eta' \eta'}^2 S(x, \eta', 0) - \partial^2 S(x', 0, \eta)$, where the first matrix is padded with zeros. Since $\partial_{\eta_n} S(x', 0, \eta) = 0$, we have $\partial_{\eta_n \eta_n}^2 S = \partial_{\eta_n x'}^2 S = \partial_{\eta_n \eta'}^2 S = 0$ at $(x', 0, \eta)$,

therefore we can remove the x_n, η_n variables, with a multiplicand of $(\partial_{x_n \eta_n}^2 S(x', 0, \eta))^2$ in the determinant. Next, by (3.6.19) $\partial_{\eta' \eta'}^2 S(x', 0, \eta) = \partial_{\eta' \eta'}^2 S(x, \eta', 0)$; therefore, the Hessian has signature zero and determinant

$$(\partial_{x_n \eta_n}^2 S(x', 0, \eta) \det \partial_{x' \eta'}^2 S(x', 0, \eta))^2.$$

Since $\partial_{x' \eta_n}^2 S(x', 0, \eta) = 0$, this is equal to $(\det \partial_{x \eta}^2 S(x', 0, \eta))^2$. Therefore, we get (3.6.18) with

$$\gamma_{\varkappa}^+(x, \xi') \gamma_{\varkappa}^-(x', \xi) = \frac{b'_0(x, \eta', 0) b_0(x', 0, \eta)}{|\det \partial_{x \eta}^2 S(x', 0, \eta)|} = \frac{b'_0(x, \eta', 0)}{b'_0(x', 0, \eta)},$$

here $(y, \eta) = \tilde{\varkappa}(x, \xi)$ and the last equality follows from (3.6.20). We then find

$$\gamma_{\varkappa}^+(x, \xi') = b'_0(x, \eta', 0)/b'_0(x', 0, \eta'), \quad \gamma_{\varkappa}^-(x', \xi) = b'_0(x', 0, \eta', 0)/b'_0(x', 0, \eta). \quad (3.6.21)$$

We now consider the case of general \varkappa . Using a partition of unity for a , we may assume that the intersection $U \cap K^0$ is arbitrary small. We now represent \varkappa as a product of several canonical relations, each of which satisfies the conditions of this Proposition and has a generating function; this will finish the proof.

First of all, consider a canonical transformation of the form

$$(x, \xi) \mapsto (y, \eta), \quad (y', \eta') = \tilde{\varkappa}(x', \xi'), \quad (y_n, \eta_n) = (x_n, \xi_n), \quad (3.6.22)$$

with $\tilde{\varkappa}$ a canonical transformation on $T^*\mathbb{R}^{n-1} \simeq K^0$. We can write $\tilde{\varkappa}$ locally as a product of canonical transformations close to the identity, each of which has a generating function – see [137, Theorems 10.4 and 11.4]. If $\tilde{S}(x', \eta')$ is a generating function for $\tilde{\varkappa}$, then $\tilde{S}(x', \eta') + x_n \eta_n$ is a generating function for (3.6.22).

Multiplying our \varkappa by a transformation of the form (3.6.22) with $\tilde{\varkappa} = (\varkappa|_{K^0})^{-1}$, we reduce to the case

$$\varkappa(x', 0, \xi', 0) = (x', 0, \xi', 0) \quad \text{for } (x', 0, \xi', 0) \in U \cap K^0.$$

If $\varkappa(x, \xi) = (y(x, \xi), \eta(x, \xi))$, since \varkappa commutes with π_{\pm} we have

$$\begin{aligned} y'(x, \xi', 0) &= y'(x', 0, \xi) = x', \\ \eta'(x, \xi', 0) &= \eta'(x', 0, \xi) = \xi'. \end{aligned} \quad (3.6.23)$$

We now claim that \varkappa has a generating function, if we shrink U to be a small neighborhood of $U \cap (\Gamma_+^0 \cup \Gamma_-^0)$ (which does not change anything since $\text{Op}_h^\Delta(a)$ is microlocalized in $\Gamma_-^0 \times \Gamma_+^0$). For that, it is enough to show that the map

$$\psi : (x, \xi) \mapsto (x, \eta(x, \xi))$$

is a diffeomorphism from U onto some open subset $\mathcal{D}_S \subset \mathbb{R}^{2n}$.

We first show that ψ is a local diffeomorphism near Γ_{\pm}^0 ; that is, the differential $\partial_{\xi} \eta$ is nondegenerate on Γ_{\pm}^0 . By (3.6.23), $\partial_{x', \xi'}(y', \eta')$ equals the identity on $\Gamma_+^0 \cup \Gamma_-^0$; moreover, on Γ_+^0 we have $\partial_{x, \xi} \eta_n = 0$ and $\partial_{x_n}(y', \eta') = 0$ and on Γ_-^0 , we have $\partial_{x', \xi} y_n = 0$ and $\partial_{\xi_n}(y', \eta') = 0$. It follows that on $\Gamma_+^0 \cup \Gamma_-^0$, $\det \partial_{\xi} \eta = \partial_{\xi_n} \eta_n$ and since \varkappa is a diffeomorphism, $0 \neq \det \partial_{(x, \xi)}(y, \eta) = \partial_{x_n} y_n \cdot \partial_{\xi_n} \eta_n$, yielding $\det \partial_{\xi} \eta \neq 0$.

It remains to note that ψ is one-to-one on $\Gamma_+^0 \cup \Gamma_-^0$, which follows immediately from the identities $\psi(x, \xi', 0) = (x, \xi', 0)$ and $\psi(x', 0, \xi) = \varkappa(x', 0, \xi)$. \square

3.6.2 General case

We now consider the case of general $\Gamma_{\pm}^{\circ}, K^{\circ}, \Lambda^{\circ}$, satisfying the assumptions from the beginning of §3.6. We start by shrinking Γ_{\pm}° so that our setup can locally be conjugated to the model case of §3.6.1. (The set \widehat{K} will be chosen in §3.7.1.)

Proposition 3.6.3. *Let $\widehat{K} \subset K^{\circ}$ be compact. Then there exist $\tilde{\delta} > 0$ and*

- *a finite collection of open sets $U_i \subset T^*X$, such that*

$$\widehat{K} \subset \widetilde{K} := \bigcup_i K_i, \quad K_i := K^{\circ} \cap U_i.$$

- *symplectomorphisms \varkappa_i defined in a neighborhood of U_i and mapping U_i onto*

$$V_{\tilde{\delta}} := \{|(x', \xi')| < \tilde{\delta}, |x_n| < \tilde{\delta}, |\xi_n| < \tilde{\delta}\} \subset T^*\mathbb{R}^n, \quad (3.6.24)$$

such that, with Γ_{\pm}^0 defined in (3.6.3),

$$\varkappa_i(U_i \cap \Gamma_{\pm}^{\circ}) = V_{\tilde{\delta}} \cap \Gamma_{\pm}^0;$$

- *compactly microlocalized Fourier integral operators*

$$B_i : C^{\infty}(X) \rightarrow C_0^{\infty}(\mathbb{R}^n), \quad B'_i : C^{\infty}(\mathbb{R}^n) \rightarrow C_0^{\infty}(X),$$

associated to \varkappa_i and \varkappa_i^{-1} , respectively, such that

$$B_i B'_i = 1 \quad \text{near } V_{\tilde{\delta}}, \quad B'_i B_i = 1 \quad \text{near } U_i. \quad (3.6.25)$$

Proof. It is enough to show that each point $\rho \in K^{\circ}$ has a neighborhood U_{ρ} and a symplectomorphism $\varkappa_{\rho} : U_{\rho} \rightarrow V_{\rho} \subset T^*\mathbb{R}^n$ such that $\varkappa_{\rho}(U_{\rho} \cap \Gamma_{\pm}^{\circ}) = V_{\rho} \cap \Gamma_{\pm}^0$; see for example [137, Theorem 11.5] for how to construct the operators B_i, B'_i locally quantizing the canonical transformations $\varkappa_{\rho}, \varkappa_{\rho}^{-1}$.

By the Darboux theorem [137, Theorem 12.1] (giving a symplectomorphism mapping an arbitrarily chosen defining function of Γ_{-}° to x_n), we can reduce to the case $\rho = 0 \in T^*\mathbb{R}^n$ and $\Gamma_{-}^{\circ} = \{x_n = 0\}$ near 0. Since $\Gamma_{+}^{\circ} \cap \Gamma_{-}^{\circ} = K^{\circ}$ is symplectic, the Poisson bracket of the defining function x_n of Γ_{-}° and any defining function φ_{+} of Γ_{+}° is nonzero at 0; thus, $\partial_{\xi_n} \varphi_{+}(0) \neq 0$ and we can write Γ_{+}° locally as the graph of some function:

$$\Gamma_{+}^{\circ} = \{\xi_n = F(x, \xi')\}.$$

Put $\varphi'_{+}(x, \xi) = \xi_n - F(x, \xi')$, then $\{\varphi'_{+}, x_n\} = 1$. It remains to apply the Darboux theorem once again, obtaining a symplectomorphism preserving x_n and mapping φ'_{+} to ξ_n . \square

We now consider the sets⁵

$$\begin{aligned}\tilde{\Gamma}_\pm &:= \bigcup_i \Gamma_\pm^i, & \Gamma_\pm^i &:= \Gamma_\pm^\circ \cap U_i, \\ \tilde{\Lambda} &:= \bigcup_i \Lambda_i, & \Lambda_i &:= \{(\rho_-, \rho_+) \in \Lambda^\circ \mid \rho_\pm \in \Gamma_\pm^i\}.\end{aligned}\tag{3.6.26}$$

Let $\widehat{\Gamma}_\pm \subset \tilde{\Gamma}_\pm$ be compact, with $\pi_\pm(\widehat{\Gamma}_\pm) = \widehat{K}$ and for each $\rho \in \widehat{K}$, the set $\pi_\pm^{-1}(\rho) \cap \widehat{\Gamma}_\pm$ is a flow line of \mathcal{V}_\pm containing ρ . Define the compact set

$$\widehat{\Lambda} := \{(\rho_-, \rho_+) \in \Lambda^\circ \mid \rho_\pm \in \widehat{\Gamma}_\pm\}\tag{3.6.27}$$

and assume that $\widehat{\Gamma}_\pm$ are chosen so that $\widehat{\Lambda} \subset \tilde{\Lambda}$. The goal of this subsection is to obtain an invariant notion of the principal symbol of Fourier integral operators in $I_{\text{comp}}(\Lambda^\circ)$, microlocally near $\widehat{\Lambda}$.

Define the diffeomorphisms $\widehat{\varkappa}_i : \Lambda_i \rightarrow V_\delta$ by the formula

$$(\varkappa_i(\rho_-), \varkappa_i(\rho_+)) = \phi(\widehat{\varkappa}_i(\rho_-, \rho_+)), \quad (\rho_-, \rho_+) \in \Lambda_i;$$

here ϕ is defined in (3.6.4).

Consider some $A \in I_{\text{comp}}(\Lambda^\circ)$, then $B_i A B_i'$ is a Fourier integral operator associated to the model canonical relation Λ^0 from §3.6.1 (with the antiderivatives on Λ° and Λ^0 chosen in the beginning of §3.6). Therefore, there exists a compactly supported classical symbol $\tilde{a}^i(x, \xi; h)$ on \mathbb{R}^{2n} such that, with Op_h^Λ defined in (3.6.5),

$$B_i A B_i' = \text{Op}_h^\Lambda(\tilde{a}^i) + \mathcal{O}(h^\infty)_{\mathcal{S}' \rightarrow \mathcal{S}}.\tag{3.6.28}$$

By (3.6.25), we find

$$A = B_i' \text{Op}_h^\Lambda(\tilde{a}^i) B_i + \mathcal{O}(h^\infty) \quad \text{microlocally near } \Lambda_i.$$

Define the function $a^i \in C^\infty(\Lambda_i)$ using the principal symbol \tilde{a}_0^i by

$$a^i = \tilde{a}_0^i \circ \widehat{\varkappa}_i.$$

By Proposition 3.6.2, applied to the Fourier integral operators $B_j B_i'$ and $B_i B_j'$ quantizing $\varkappa = \varkappa_j \circ \varkappa_i^{-1}$ and \varkappa^{-1} , respectively, with $U' = \varkappa_i(U_i \cap U_j)$, $V' = \varkappa_j(U_i \cap U_j)$ we see that whenever $\Lambda_i \cap \Lambda_j \neq \emptyset$, we have

$$a^i|_{\Lambda_i \cap \Lambda_j} = (\gamma_{ij}^- \otimes \gamma_{ij}^+) a^j|_{\Lambda_i \cap \Lambda_j},\tag{3.6.29}$$

where γ_{ij}^\pm are smooth functions on $\Gamma_\pm^i \cap \Gamma_\pm^j$ and $\gamma_{ij}^\pm|_K = 1$. Moreover, $\gamma_{ji}^\pm = (\gamma_{ij}^\pm)^{-1}$ and $\gamma_{ij}^\pm \gamma_{jk}^\pm = \gamma_{ik}^\pm$ on $\Gamma_\pm^i \cap \Gamma_\pm^j \cap \Gamma_\pm^k$ (this can be seen either from the fact that the formulas (3.6.29)

⁵The open subsets $\tilde{\Gamma}_\pm, \tilde{K}$ of $\Gamma_\pm^\circ, K^\circ$ should not be confused with the incoming/outgoing tails and the trapped set for the Lorentzian case studied in Chapter 4.

for different i, j have to be compatible with each other, or directly from (3.6.21)). Therefore, we can consider smooth line bundles \mathcal{E}_\pm over $\tilde{\Gamma}_\pm$ with smooth sections e_\pm^i of $\mathcal{E}_\pm|_{\Gamma_\pm^i}$ such that $e_\pm^j = \gamma_{ij}^\pm e_\pm^i$ on $\Gamma_\pm^i \cap \Gamma_\pm^j$ – see for example [70, §6.4].

Define the line bundle \mathcal{E} over $\tilde{\Lambda}$ using the projection maps from (3.6.1):

$$\mathcal{E} = (\tilde{\pi}_-^* \mathcal{E}^-) \otimes (\tilde{\pi}_+^* \mathcal{E}^+)$$

and for $A \in I_{\text{comp}}(\Lambda^\circ)$, the symbol $\sigma_\Lambda(A) \in C^\infty(\tilde{\Lambda}; \mathcal{E})$ by the formula

$$\sigma_\Lambda(A)|_{\Lambda_i} = a^i(\tilde{\pi}_-^* e_-^i \otimes \tilde{\pi}_+^* e_+^i). \quad (3.6.30)$$

Note that the bundle \mathcal{E} can be studied in detail using the global theory of Fourier integral operators (see for instance [72, §25.1]). However, the situation in our special case is considerably simplified, since the Maslov bundle does not appear.

We have $\sigma_\Lambda(A) = 0$ near $\hat{\Lambda}$ if and only if $A \in hI_{\text{comp}}(\Lambda^\circ)$ microlocally near $\hat{\Lambda}$. Moreover, for all $a \in C^\infty(\tilde{\Lambda}; \mathcal{E})$, there exists $A \in I_{\text{comp}}(\Lambda^\circ)$ such that $\sigma_\Lambda(A) = a$ near $\hat{\Lambda}$.

The restrictions $\mathcal{E}_\pm|_{\tilde{K}}$ are canonically trivial; that is, for $a_\pm \in C^\infty(\tilde{\Gamma}_\pm; \mathcal{E}_\pm)$, we can view $a_\pm|_{\tilde{K}}$ as a function on \tilde{K} , by taking $e_\pm^i|_{K_i} = 1$. The bundles \mathcal{E}_\pm are trivial:

Proposition 3.6.4. *There exist sections $a_\pm \in C^\infty(\tilde{\Gamma}_\pm; \mathcal{E}_\pm)$, nonvanishing near $\hat{\Gamma}_\pm$ and such that $a_\pm|_{\tilde{K}} = 1$ near \hat{K} .*

Proof. Since γ_{ij}^\pm is a nonvanishing smooth function on $\Gamma_\pm^i \cap \Gamma_\pm^j$ such that $\gamma_{ij}^\pm|_{K_i \cap K_j} = 1$, we can write

$$\gamma_{ij}^\pm = \exp(f_{ij}^\pm),$$

where f_{ij}^\pm is a uniquely defined function on $\Gamma_\pm^i \cap \Gamma_\pm^j$, such that $f_{ij}^\pm|_{K_i \cap K_j} = 0$. We now put near $\hat{\Gamma}_\pm$,

$$a_\pm|_{\Gamma_\pm^i} = \exp(b_\pm^i) e_\pm^i,$$

where $b_\pm^i \in C^\infty(\Gamma_\pm^i)$ are such that near $\hat{\Gamma}_\pm$ and \hat{K} respectively,

$$(b_\pm^i - b_\pm^j)|_{\Gamma_\pm^i \cap \Gamma_\pm^j} = f_{ij}^\pm, \quad b_\pm^i|_{K_i} = 0.$$

Such functions exist since f_{ij}^\pm is a cocycle:

$$f_{ii}^\pm = f_{ij}^\pm + f_{ji}^\pm = 0; \quad f_{ij}^\pm + f_{jk}^\pm = f_{ik}^\pm \quad \text{on } \Gamma_\pm^i \cap \Gamma_\pm^j \cap \Gamma_\pm^k$$

and since the sheaf of smooth functions is fine; more precisely, if $1 = \sum_i \chi_i$ is a partition of unity on $\hat{\Gamma}_\pm$, with $\text{supp } \chi_i \subset \Gamma_\pm^i$, we put

$$b_\pm^i = \sum_k \chi_k f_{ik}^\pm. \quad \square$$

We now state the properties of the calculus, following directly from (3.6.9)–(3.6.11), the general theory of Fourier integral operators, and Egorov’s Theorem [137, Theorem 11.1] (see the beginning of §3.6 for multiplying two elements of $I_{\text{comp}}(\Lambda^\circ)$):

Proposition 3.6.5. *Assume that $A_1, A_2 \in I_{\text{comp}}(\Lambda^\circ), P \in \Psi^k(X)$. Then A_1A_2, A_1P, PA_1 lie in $I_{\text{comp}}(\Lambda^\circ)$, and*

$$\sigma_\Lambda(A_1A_2)(\rho_-, \rho_+) = \sigma_\Lambda(A_2)(\rho_-, \pi_-(\rho_-)) \otimes \sigma_\Lambda(A_1)(\pi_+(\rho_+), \rho_+), \quad (3.6.31)$$

$$\sigma_\Lambda(A_1P)(\rho_-, \rho_+) = \sigma(P)(\rho_-) \cdot \sigma_\Lambda(A_1)(\rho_-, \rho_+), \quad (3.6.32)$$

$$\sigma_\Lambda(PA_1)(\rho_-, \rho_+) = \sigma(P)(\rho_+) \cdot \sigma_\Lambda(A_1)(\rho_-, \rho_+). \quad (3.6.33)$$

Here in (3.6.31), $\sigma_\Lambda(A_2)(\rho_-, \pi_-(\rho_-))$ and $\sigma_\Lambda(A_1)(\pi_+(\rho_+), \rho_+)$ are considered as sections of \mathcal{E}_- and \mathcal{E}_+ , respectively.

We next give a parametrix construction for operators of the form $1 - A$, with $A \in I_{\text{comp}}(\Lambda^\circ)$, needed in §3.9:

Proposition 3.6.6. *Let $A \in I_{\text{comp}}(\Lambda^\circ)$ and assume that*

$$\text{WF}_h(A) \subset \widehat{\Lambda}; \quad \sigma_\Lambda(A)|_{\widehat{K}} \neq 1 \text{ everywhere.}$$

Then there exists $B \in I_{\text{comp}}(\Lambda^\circ)$ with $\text{WF}_h(B) \subset \widehat{\Lambda}$, and such that

$$(1 - A)(1 - B) = 1 + \mathcal{O}(h^\infty), \quad (1 - B)(1 - A) = 1 + \mathcal{O}(h^\infty).$$

Moreover, B is uniquely defined modulo $\mathcal{O}(h^\infty)$ and

$$\sigma_\Lambda(B)(\rho_-, \rho_+) = \frac{\sigma_\Lambda(A)(\rho_-, \pi_-(\rho_-)) \otimes \sigma_\Lambda(A)(\pi_+(\rho_+), \rho_+)}{\sigma_\Lambda(A)(\pi_-(\rho_-), \pi_+(\rho_+)) - 1} - \sigma_\Lambda(A)(\rho_-, \rho_+). \quad (3.6.34)$$

Proof. Take any $B_1 \in I_{\text{comp}}(\Lambda^\circ)$ with $\text{WF}_h(B_1) \subset \widehat{\Lambda}$ and symbol given by (3.6.34). By (3.6.31), $(1 - A)(1 - B_1) = 1 - hR$, for some $R \in I_{\text{comp}}(\Lambda^\circ)$ with $\text{WF}_h(R) \subset \widehat{\Lambda}$. Define $B_2 \in I_{\text{comp}}(\Lambda^\circ)$ by the asymptotic Neumann series

$$-B_2 \sim \sum_{j \geq 1} h^j R^j.$$

Define $B \in I_{\text{comp}}(\Lambda^\circ)$ by the identity $1 - B = (1 - B_1)(1 - B_2)$, then $(1 - A)(1 - B) = 1 + \mathcal{O}(h^\infty)$. Similarly, we construct $B' \in I_{\text{comp}}(\Lambda^\circ)$ such that $(1 - B')(1 - A) = 1 + \mathcal{O}(h^\infty)$. A standard algebraic argument, see for example the proof of [71, Theorem 18.1.9], shows that $B' = B + \mathcal{O}(h^\infty)$ and both are determined uniquely modulo $\mathcal{O}(h^\infty)$. \square

We finish this subsection with a trace formula for operators in $I_{\text{comp}}(\Lambda^\circ)$, used in §3.10:

Proposition 3.6.7. *Assume that $A \in I_{\text{comp}}(\Lambda^\circ)$ and $\text{WF}_h(A) \subset \widehat{\Lambda}$. Then, with $d\text{Vol}_\sigma = \sigma_S^{n-1}/(n-1)!$ denoting the symplectic volume form and $j_K : K^\circ \rightarrow \Lambda^\circ$ defined in (3.6.2),*

$$(2\pi h)^{n-1} \text{Tr } A = \int_{\widehat{K}} \sigma_\Lambda(A) \circ j_K d\text{Vol}_\sigma + \mathcal{O}(h).$$

Proof. By a microlocal partition of unity, we reduce to the case when $\text{WF}_h(A)$ lies entirely in one of the sets Λ_i defined in (3.6.26). If \tilde{a}_i is defined by (3.6.28), then by the cyclicity of the trace, $\text{Tr } A = \text{Tr } \text{Op}_h^\Lambda(\tilde{a}_i) + \mathcal{O}(h^\infty)$. It remains to note that for any $a(x, \xi) \in C_0^\infty(\mathbb{R}^{2n})$,

$$(2\pi h)^{n-1} \text{Tr } \text{Op}_h^\Lambda(a) = \int_{\mathbb{R}^{2n-2}} a(x', 0, \xi', 0) dx' d\xi' + \mathcal{O}(h),$$

seen directly from (3.6.5) by the method of stationary phase in the x_n, ξ_n variables. \square

3.6.3 Microlocal idempotents

In this subsection, we establish properties of microlocal idempotents associated to the Lagrangian Λ° considered in §3.6.2, microlocally on the compact set $\widehat{\Lambda}$ defined in (3.6.27). We use the principal symbol σ_Λ constructed in (3.6.30).

Definition 3.6.8. *We call $A \in I_{\text{comp}}(\Lambda^\circ)$ a microlocal idempotent of order $k > 0$ near $\widehat{\Lambda}$, if $A^2 = A + \mathcal{O}(h^k)_{I_{\text{comp}}(\Lambda^\circ)}$ microlocally near $\widehat{\Lambda}$ and $\sigma_\Lambda(A)$ does not vanish on $\widehat{\Lambda}$.*

In the following Proposition, part 1 is concerned with the principal part of the idempotent equation; part 2 establishes a normal form for microlocal idempotents, making it possible to conjugate them microlocally to the operator $\text{Op}_h^\Lambda(1)$ from (3.6.16). Part 3 is used to construct a global idempotent of all orders in Proposition 3.6.10 below, while part 4 establishes properties of commutators used in the construction of §3.7.

Proposition 3.6.9. *1. $A \in I_{\text{comp}}(\Lambda^\circ)$ is a microlocal idempotent of order 1 near $\widehat{\Lambda}$ if and only if near $\widehat{\Lambda}$,*

$$\sigma_\Lambda(A)(\rho_-, \rho_+) = a_0^-(\rho_-) \otimes a_0^+(\rho_+) \quad (3.6.35)$$

for some sections $a_0^\pm \in C^\infty(\widetilde{\Gamma}_\pm; \mathcal{E}_\pm)$ nonvanishing near $\widehat{\Gamma}_\pm$ and such that $a_0^\pm|_{\widehat{K}} = 1$ near \widehat{K} . Moreover, a_0^\pm are uniquely determined by A on $\widehat{\Gamma}_\pm$.

2. If $A, B \in I_{\text{comp}}(\Lambda^\circ)$ are two microlocal idempotents of order $k > 0$ near $\widehat{\Lambda}$, then there exists an operator $Q \in \Psi^{\text{comp}}(X)$, elliptic on $\widehat{\Gamma}_+ \cup \widehat{\Gamma}_-$ and such that $B = QAQ^{-1} + \mathcal{O}(h^k)_{I_{\text{comp}}(\Lambda^\circ)}$ microlocally near $\widehat{\Lambda}$. Here Q^{-1} denotes an elliptic parametrix of Q constructed in Proposition 3.3.3.

3. If $A \in I_{\text{comp}}(\Lambda^\circ)$ is a microlocal idempotent of order $k > 0$ near $\widehat{\Lambda}$, and $A^2 - A = h^k R_k + \mathcal{O}(h^\infty)$ microlocally near $\widehat{\Lambda}$ for some $R_k \in I_{\text{comp}}(\Lambda^\circ)$, then for $\rho_\pm \in \widetilde{\Gamma}_\pm$ near $\widehat{\Gamma}_\pm$,

$$\begin{aligned} \sigma_\Lambda(R_k)(\pi_+(\rho_+), \rho_+) &= \sigma_\Lambda(R_k)(\pi_+(\rho_+), \pi_+(\rho_+)) \cdot a_0^+(\rho_+), \\ \sigma_\Lambda(R_k)(\rho_-, \pi_-(\rho_-)) &= \sigma_\Lambda(R_k)(\pi_-(\rho_-), \pi_-(\rho_-)) \cdot a_0^-(\rho_-), \end{aligned} \quad (3.6.36)$$

with a_0^\pm defined in (3.6.35).

4. If $A \in I_{\text{comp}}(\Lambda^\circ)$ is a microlocal idempotent of all orders near $\widehat{\Lambda}$, $P \in \Psi^{\text{comp}}(X)$ is compactly supported, and $[P, A] = h^k S_k + \mathcal{O}(h^\infty)$ microlocally near $\widehat{\Lambda}$ for some $S_k \in I_{\text{comp}}(\Lambda^\circ)$, then near $\widehat{\Lambda}$,

$$\sigma_\Lambda(S_k)(\rho_-, \rho_+) = a_0^-(\rho_-) \otimes \sigma_\Lambda(S_k)(\pi_+(\rho_+), \rho_+) + \sigma_\Lambda(S_k)(\rho_-, \pi_-(\rho_-)) \otimes a_0^+(\rho_+).$$

In particular, $\sigma_\Lambda(S_k) \circ j_K = 0$ near \widehat{K} , with $j_K : K^\circ \rightarrow \Lambda^\circ$ defined in (3.6.2).

Proof. In this proof, all the equalities of operators in $I_{\text{comp}}(\Lambda^\circ)$ and the corresponding symbols are presumed to hold microlocally near $\widehat{\Lambda}$.

1. By (3.6.31), we have $A^2 = A + \mathcal{O}(h)$ if and only if

$$\sigma_\Lambda(A)(\rho_-, \rho_+) = \sigma_\Lambda(A)(\rho_-, \pi_-(\rho_-)) \otimes \sigma_\Lambda(A)(\pi_+(\rho_+), \rho_+).$$

In particular, restricting to \widehat{K} , we obtain $\sigma_\Lambda(A) = \sigma_\Lambda(A)^2$ near \widehat{K} . Since $\sigma_\Lambda(A)$ is nonvanishing, we get $\sigma_\Lambda(A)|_{\widehat{K}} = 1$ near \widehat{K} . It then remains to put $a_0^-(\rho_-) = \sigma_\Lambda(A)(\rho_-, \pi_-(\rho_-))$ and $a_0^+(\rho_+) = \sigma_\Lambda(A)(\pi_+(\rho_+), \rho_+)$.

2. We use induction on k . For $k = 1$, we have by (3.6.32) and (3.6.33),

$$\sigma_\Lambda(QAQ^{-1})(\rho_-, \rho_+) = \frac{\sigma(Q)(\rho_+)}{\sigma(Q)(\rho_-)} \sigma_\Lambda(A)(\rho_-, \rho_+).$$

If a_0^\pm and b_0^\pm are given by (3.6.35), then it is enough to take any Q with

$$\sigma(Q)|_{\widehat{\Gamma}_-} = a_0^-/b_0^-, \quad \sigma(Q)|_{\widehat{\Gamma}_+} = b_0^+/a_0^+, \quad (3.6.37)$$

this is possible since the restrictions of a_0^\pm and b_0^\pm to \widehat{K} are equal to 1.

Now, assuming the statement is true for $k \geq 1$, we prove it for $k + 1$. We have $B = \widetilde{Q}A\widetilde{Q}^{-1} + \mathcal{O}(h^k)$ for some $\widetilde{Q} \in \Psi^{\text{comp}}$ elliptic on $\widehat{\Gamma}_+ \cup \widehat{\Gamma}_-$; replacing A by $\widetilde{Q}A\widetilde{Q}^{-1}$, we may assume that $B = A + \mathcal{O}(h^k)$. Then $B - A = h^k R_k$ for some $R_k \in I_{\text{comp}}(\Lambda^\circ)$; since both A and B are microlocal idempotents of order $k + 1$, we find $R_k = AR_k + R_k A + \mathcal{O}(h)$ and thus by (3.6.31),

$$\sigma_\Lambda(R_k)(\rho_-, \rho_+) = a_0^-(\rho_-) \otimes \sigma_\Lambda(R_k)(\pi_+(\rho_+), \rho_+) + \sigma_\Lambda(R_k)(\rho_-, \pi_-(\rho_-)) \otimes a_0^+(\rho_+). \quad (3.6.38)$$

Take $Q = 1 + h^k Q_k$ for some $Q_k \in \Psi^{\text{comp}}$, then $Q^{-1} = 1 - h^k Q_k + \mathcal{O}(h^{k+1})$ and

$$QAQ^{-1} = A + h^k [Q_k, A] + \mathcal{O}(h^{k+1}).$$

Now, $B = QAQ^{-1} + \mathcal{O}(h^{k+1})$ if and only if

$$(\sigma(Q_k)(\rho_+) - \sigma(Q_k)(\rho_-))a_0^-(\rho_-) \otimes a_0^+(\rho_+) = \sigma_\Lambda(R_k)(\rho_-, \rho_+).$$

By (3.6.38), it is enough to choose Q_k such that for $\rho_{\pm} \in \tilde{\Gamma}_{\pm}$,

$$\sigma(Q_k)(\rho_-) = -\frac{\sigma_{\Lambda}(R_k)(\rho_-, \pi_-(\rho_-))}{a_0^-(\rho_-)}, \quad \sigma(Q_k)(\rho_+) = \frac{\sigma_{\Lambda}(R_k)(\pi_+(\rho_+), \rho_+)}{a_0^+(\rho_+)},$$

this is possible since $\sigma_{\Lambda}(R_k) \circ j_K = 0$ (with j_K defined in (3.6.2)) as follows from (3.6.38).

3. Since this is a local statement, we can use (3.6.28) to reduce to the model case of §3.6.1. Using part 2 and the fact that the operator $\text{Op}_h^{\Lambda}(1)$ considered in (3.6.16) is a microlocal idempotent of all orders, we can write

$$A = Q \text{Op}_h^{\Lambda}(1) Q^{-1} + h^k A_k,$$

for some elliptic $Q \in \Psi^{\text{comp}}$ and $A_k \in I_{\text{comp}}(\Lambda^0)$. Then

$$R_k = Q \text{Op}_h^{\Lambda}(1) Q^{-1} A_k + A_k Q \text{Op}_h^{\Lambda}(1) Q^{-1} - A_k + \mathcal{O}(h);$$

(3.6.36) follows by (3.6.31) since $\sigma_{\Lambda}(Q \text{Op}_h^{\Lambda}(1) Q^{-1}) = \sigma_{\Lambda}(A)$ is given by (3.6.35).

4. As in part 3, we reduce to the model case of §3.6.1 and use part 2 to write $A = Q \text{Op}_h^{\Lambda}(1) Q^{-1} + \mathcal{O}(h^{\infty})$; then

$$[P, A] = Q[Q^{-1} P Q, \text{Op}_h^{\Lambda}(1)] Q^{-1} + \mathcal{O}(h^{\infty}).$$

Put $\tilde{P} = Q^{-1} P Q$; by (3.6.13) and (3.6.14) we have $[\tilde{P}, \text{Op}_h^{\Lambda}(1)] = \text{Op}_h^{\Lambda}(s \circ \phi)$, where ϕ is given by (3.6.4) and

$$s(\rho_-, \rho_+; h) = \tilde{p}(\rho_+; h) - \tilde{p}(\rho_-; h),$$

where $\tilde{P} = \text{Op}_h(\tilde{p})$; thus

$$s(\rho_-, \rho_+; h) = s(\pi_+(\rho_+), \rho_+; h) + s(\rho_-, \pi_-(\rho_-); h).$$

It remains to conjugate by Q , keeping in mind (3.6.37). □

We can use part 3 of Proposition 3.6.9, together with the triviality of the bundles \mathcal{E}_{\pm} , to show existence of a global idempotent, which is the starting point of the construction in §3.7.

Proposition 3.6.10. *There exists a microlocal idempotent $\tilde{\Pi} \in I_{\text{comp}}(\Lambda^{\circ})$ of all orders near $\hat{\Lambda}$.*

Proof. We argue inductively, constructing microlocal idempotents $\tilde{\Pi}_k$ of order k for each k and taking the asymptotic limit. To construct $\tilde{\Pi}_1$, we use part 1 of Proposition 3.6.9; the existence of symbols a_0^{\pm} was shown in Proposition 3.6.4.

Now, assume that $\tilde{\Pi}_k$ is a microlocal idempotent of order $k > 0$. By part 3 of Proposition 3.6.9, we have $\tilde{\Pi}_k^2 - \tilde{\Pi}_k = h^k R_k + \mathcal{O}(h^{\infty})$ microlocally near $\hat{\Lambda}$, where $R_k \in I_{\text{comp}}(\Lambda^{\circ})$ and $r_k = \sigma_{\Lambda}(R_k)$ satisfies (3.6.36). Put $\tilde{\Pi}_{k+1} = \tilde{\Pi}_k + h^k B_k$, for some $B_k \in I_{\text{comp}}(\Lambda^{\circ})$. We need to choose B_k so that microlocally near $\hat{\Lambda}$,

$$R_k + \tilde{\Pi}_k B_k + B_k \tilde{\Pi}_k - B_k = \mathcal{O}(h).$$

Taking $b_k = \sigma_\Lambda(B_k)$, by (3.6.31) this translates to

$$b_k(\rho_-, \rho_+) = a_0^-(\rho_-) \otimes b_k(\pi_+(\rho_+), \rho_+) + b_k(\rho_-, \pi_-(\rho_-)) \otimes a_0^+(\rho_+) + r_k(\rho_-, \rho_+).$$

By (3.6.36), it is enough to take any $b_k^\pm \in C^\infty(\tilde{\Gamma}_\pm; \mathcal{E}_\pm)$ such that near \widehat{K} , $b_k^\pm|_{\widehat{K}} = -r_k \circ j_K$, with j_K defined in (3.6.2) (for example, $b_k^\pm = -(r_k \circ j_K \circ \pi_\pm)a_0^\pm$) and put

$$b_k(\rho_-, \rho_+) := a_0^-(\rho_-) \otimes b_k^+(\rho_+) + b_k^-(\rho_-) \otimes a_0^+(\rho_+) + r_k(\rho_-, \rho_+). \quad \square$$

3.6.4 Annihilating ideals

Assume that $\Pi \in I_{\text{comp}}(\Lambda^\circ)$ is a microlocal idempotent of all orders near the set $\widehat{\Lambda}$ introduced in (3.6.27), see Definition 3.6.8. We are interested in the following equations:

$$\Pi\Theta_- = \mathcal{O}(h^\infty) \quad \text{microlocally near } \widehat{\Lambda}, \quad (3.6.39)$$

$$\Theta_+\Pi = \mathcal{O}(h^\infty) \quad \text{microlocally near } \widehat{\Lambda}, \quad (3.6.40)$$

where Θ_\pm are pseudodifferential operators. The solutions to (3.6.39) form a right ideal and the solutions to (3.6.40) form a left ideal in the algebra of pseudodifferential operators. Moreover, by (3.6.32), (3.6.33), each solution Θ_\pm to the equations (3.6.39), (3.6.40) satisfies $\sigma(\Theta_\pm)|_{\Gamma_\pm} = 0$ near $\widehat{\Gamma}_\pm$ and each Θ_\pm such that $\text{WF}_h(\Theta_\pm) \cap \widehat{\Gamma}_\pm = \emptyset$ solves these equations.

Note that in the model case of §3.6.1, with Π equaling the operator $\text{Op}_h^\Lambda(1)$ from (3.6.16), and with the quantization procedure Op_h defined in (3.6.6), the set of solutions to (3.6.39) is the set of operators $\text{Op}_h(\theta_-)$ with $\theta_-|_{x_n=0} = 0$; that is, the right ideal generated by the operator x_n . The set of solutions to (3.6.40) is the set of operators $\text{Op}_h(\theta_+)$ with $\theta_+|_{\xi_n=0} = 0$; that is, the left ideal generated by the operator hD_{x_n} . This follows from the multiplication formulas (3.6.13) and (3.6.14), together with the multiplication formulas for the standard quantization [137, (4.3.16)].

We start by showing that our ideals are principal in the general setting:

Proposition 3.6.11. *1. For each defining functions φ_\pm of Γ_\pm° near $\widehat{\Gamma}_\pm$, there exist operators Θ_\pm solving (3.6.39), (3.6.40), such that $\sigma(\Theta_\pm) = \varphi_\pm$ near $\widehat{\Gamma}_\pm$. Such operators are called basic solutions of the corresponding equations.*

2. If Θ_\pm, Θ'_\pm are solutions to (3.6.39), (3.6.40), and moreover Θ_\pm are basic solutions, then there exist $Z_\pm \in \Psi^{\text{comp}}$ such that $\Theta'_- = \Theta_-Z_- + \mathcal{O}(h^\infty)$ microlocally near $\widehat{\Gamma}_-$ and $\Theta'_+ = Z_+\Theta_+ + \mathcal{O}(h^\infty)$ microlocally near $\widehat{\Gamma}_+$.

Proof. We concentrate on the equation (3.6.39); (3.6.40) is handled similarly. Since the equations (3.6.39) and $\Theta' = \Theta_-Z_-$ are linear in Θ_- and Θ', Z_- , respectively, we can use (3.6.28) and a pseudodifferential partition of unity to reduce to the model case of §3.6.1. Using part 2 of Proposition 3.6.9, we can furthermore assume that $\Pi = \text{Op}_h^\Lambda(1)$.

To show part 1, in the model case, we can take $\Theta_- = \text{Op}_h(\varphi_-)$, where $\varphi_-(x, \xi)$ is the given defining function of $\{x_n = 0\}$. For part 2, if $\Theta_- = \text{Op}_h(\varphi_-)$ and $\Theta'_- = \text{Op}_h(\theta'_-)$, then

we can write microlocally near $\widehat{\Gamma}_-$, $\Theta_- = x_n Y_- + \mathcal{O}(h^\infty)$, where $Y_- \in \Psi^{\text{comp}}$ is elliptic on $\widehat{\Gamma}_-$; in fact, $Y_- = \text{Op}_h(\varphi_-/x_n)$. Similarly we can write $\Theta'_- = x_n Y'_- + \mathcal{O}(h^\infty)$ microlocally near $\widehat{\Gamma}_-$, for some $Y'_- \in \Psi^{\text{comp}}$; it remains to put $Z_- = Y_-^{-1} Y'_-$ microlocally near $\widehat{\Gamma}_-$. \square

For the microlocal estimate on the kernel of Π in §3.8.2, we need an analog of the following fact:

$$f \in C^\infty(\mathbb{R}^n) \implies f(x) - f(x', 0) = x_n g(x), \quad g \in C^\infty(\mathbb{R}^n), \quad (3.6.41)$$

where $f(x', 0)$ is replaced by Πf and multiplication by x_n is replaced by a basic solution to (3.6.39). We start with a technical lemma for the model case:

Lemma 3.6.12. *Consider the operator $\Xi_0 : C^\infty(\mathbb{R}^n) \rightarrow C^\infty(\mathbb{R}^n)$ defined by*

$$\Xi_0 f(x', x_n) = \frac{f(x', x_n) - f(x', 0)}{x_n} = \int_0^1 (\partial_{x_n} f)(x', tx_n) dt.$$

Then:

1. Ξ_0 is bounded $H^1(\mathbb{R}^n) \rightarrow L^2(\mathbb{R}^n)$ and thus $\|\Xi_0\|_{H_h^1 \rightarrow L^2} = \mathcal{O}(h^{-1})$.
2. The wavefront set $\text{WF}_h(\Xi_0)$ defined in §3.3.1 satisfies⁶

$$\begin{aligned} \text{WF}_h(\Xi_0) \cap T^*(\mathbb{R}^n \times \mathbb{R}^n) &\subset \Delta(T^*\mathbb{R}^n) \cup \Lambda^0 \\ &\cup \{(x', 0, \xi, x', 0, \xi', t\xi_n) \mid (x', \xi) \in \mathbb{R}^{2n-1}, t \in [0, 1]\}, \end{aligned}$$

where $\Delta(T^*\mathbb{R}^n) \subset T^*\mathbb{R}^n \times T^*\mathbb{R}^n$ is the diagonal and Λ^0 is defined using (3.6.3).

Proof. 1. Put $\lambda_t f(x', x_n) = (\partial_{x_n} f)(x', tx_n)$; then

$$\|\Xi_0 f\|_{L^2} \leq \int_0^1 \|\lambda_t f\|_{L^2} dt \leq \int_0^1 t^{-1/2} \|f\|_{H^1} dt \leq 2\|f\|_{H^1}.$$

2. Denote elements of $T^*(\mathbb{R}^n \times \mathbb{R}^n)$ by (x, ξ, y, η) . If $\chi \in C_0^\infty(\mathbb{R})$ is supported away from zero, then, with $\text{Op}_h^\Lambda(1)$ defined in (3.6.16),

$$\chi(x_n)\Xi_0 = \frac{\chi(x_n)}{x_n} (1 - \text{Op}_h^\Lambda(1)).$$

Since $\chi(x_n)/x_n$ is a smooth function, the identity operator has wavefront set on the diagonal, and $\text{WF}_h(\text{Op}_h^\Lambda(1)) \cap T^*(\mathbb{R}^n \times \mathbb{R}^n) \subset \Lambda^0$, we find

$$\text{WF}_h(\Xi_0) \cap T^*(\mathbb{R}^n \times \mathbb{R}^n) \cap \{y_n \neq 0\} \subset \Delta(T^*\mathbb{R}^n) \cup \Lambda^0.$$

Similarly, one has $\Xi_0 \chi(x_n) = \chi(x_n)/x_n$; therefore,

$$\text{WF}_h(\Xi_0) \cap \{x_n \neq 0\} \subset \Delta(T^*\mathbb{R}^n).$$

⁶It would be interesting to understand the microlocal structure of Ξ_0 , starting from the fact that its wavefront set lies in the union of three Lagrangian submanifolds.

To handle the remaining part of the wavefront set, take $a, b \in C_0^\infty(T^*\mathbb{R}^n)$ such that

$$(x', tx_n, \xi) \in \text{supp } a, t \in [0, 1] \implies (x, \xi', t\xi_n) \notin \text{supp } b.$$

We claim that for any $\psi \in C_0^\infty(\mathbb{R}^n)$,

$$\text{Op}_h(b)\psi \Xi_0 \text{Op}_h(a)\psi = \mathcal{O}(h^\infty); \quad (3.6.42)$$

indeed, the Schwartz kernel of this operator is

$$\begin{aligned} \mathcal{K}(y, x) &= (2\pi h)^{-2n} \int_{\mathbb{R}^{3n} \times [0,1]} e^{\frac{i}{h}((y-z)\cdot\eta + (z'-x')\cdot\xi' + (tz_n - x_n)\xi_n)} \\ &b(y, \eta)\psi(z)(ih^{-1}\xi_n a(z', tz_n, \xi) + (\partial_{z_n} a)(z', tz_n, \xi))\psi(x) d\xi d\eta dz dt. \end{aligned}$$

The stationary points of the phase in the (ξ, η, z) variables are given by

$$z = y, \quad x' = y', \quad x_n = ty_n, \quad \eta' = \xi', \quad \eta_n = t\xi_n$$

and lie outside of the support of the amplitude; by the method of nonstationary phase in the (ξ, η, z) variables, the integral is $\mathcal{O}(h^\infty)_{C^\infty}$. Now, (3.6.42) implies that

$$\begin{aligned} &\text{WF}_h(\Xi_0) \cap T^*(\mathbb{R}^n \times \mathbb{R}^n) \cap \{x_n = y_n = 0\} \\ &\subset \{(x', 0, \xi, x', 0, \xi', t\xi_n) \mid (x', \xi) \in \mathbb{R}^{2n-1}, t \in [0, 1]\}, \end{aligned}$$

which finishes the proof. \square

The microlocal analog of (3.6.41) in the general case is now given by

Proposition 3.6.13. *Let $\Pi \in I_{\text{comp}}(\Lambda^\circ)$ be a microlocal idempotent of all orders near $\widehat{\Lambda}$ and Θ_- be a basic solution to (3.6.39), see Proposition 3.6.11. Then there exists an operator $\Xi : C^\infty(X) \rightarrow C_0^\infty(X)$ such that:*

1. $\text{WF}_h(\Xi)$ is a compact subset of $T^*(M \times M)$ and $\|\Xi\|_{L^2 \rightarrow L^2} = \mathcal{O}(h^{-1})$;
2. $\text{WF}_h(\Xi) \subset \Delta(T^*M) \cup \Lambda^\circ \cup \Upsilon$, where $\Delta(T^*M) \subset T^*M \times T^*M$ is the diagonal and Υ consists of all (ρ_-, ρ'_-) such that $\rho_-, \rho'_- \in \Gamma_-$ and ρ'_- lies on the segment of the flow line of \mathcal{V}_- between ρ_- and $\pi_-(\rho_-)$;
3. $1 - \Pi = \Theta_- \Xi + \mathcal{O}(h^\infty)$ microlocally near $\widehat{K} \times \widehat{K}$.

Proof. By (3.6.28) and a microlocal partition of unity, we can reduce to the model case of §3.6.1. Moreover, by part 2 of Proposition 3.6.9, we may conjugate by a pseudodifferential operator to make $\Pi = \text{Op}_h^\Lambda(1)$. Finally, by part 2 of Proposition 3.6.11 we can multiply Θ_- on the right by an elliptic pseudodifferential operator to make $\Theta_- = \text{Op}_h(x_n)$. Then we can take $\Xi = A\Xi_0 A$, with Ξ_0 defined in Lemma 3.6.12 and $A \in \Psi^{\text{comp}}(\mathbb{R}^n)$ compactly supported, with $A = 1 + \mathcal{O}(h^\infty)$ microlocally near \widehat{K} . \square

3.7 The projector Π

In this section, we construct the microlocal projector Π near a neighborhood \widehat{W} of $K \cap p^{-1}([\alpha_0, \alpha_1])$ discussed in the introduction (Theorem 3.3 in §3.7.1). In §3.7.2, we study the annihilating ideals for Π in \widehat{W} using §3.6.4.

3.7.1 Construction of Π

Assume that the conditions of §§3.4.1 and 3.5.1 hold. Consider the sets Γ_{\pm}° and $K^{\circ} = \Gamma_{+}^{\circ} \cap \Gamma_{-}^{\circ}$ defined in (3.5.10) and let Λ° be given by (3.5.12). Put

$$\widehat{K} := K \cap p^{-1}([\alpha_0 - \delta_1/2, \alpha_1 + \delta_1/2]) \subset K^{\circ},$$

here δ_1 is defined in §3.5.4. The sets Γ_{\pm}° satisfy the assumptions listed in the beginning of §3.6, as follows from §§3.5.1 and 3.5.4.

We choose $\delta > 0$ small enough so that Lemma 3.5.1 holds (we will impose more conditions on δ in §3.7.2) and consider the sets

$$\begin{aligned} \widehat{W} &:= U_{\delta} \cap p^{-1}([\alpha_0 - \delta_1/2, \alpha_1 + \delta_1/2]), \\ \widehat{\Gamma}_{\pm} &:= \Gamma_{\pm}^{\circ} \cap \widehat{W}, \quad \widehat{\Lambda} := \Lambda^{\circ} \cap (\widehat{W} \times \widehat{W}). \end{aligned} \tag{3.7.1}$$

Here U_{δ} is defined in (3.5.8). We now apply Proposition 3.6.3; for δ small enough, $\widehat{W}, \widehat{\Gamma}_{\pm}$ are compact and $\widehat{\Gamma}_{\pm}, \widehat{\Lambda}$ satisfy the conditions listed after (3.6.26). Then (3.6.30) defines the principal symbol $\sigma_{\Lambda}(A)$ on a neighborhood of $\widehat{\Lambda}$ in Λ° for each $A \in I_{\text{comp}}(\Lambda^{\circ})$.

Theorem 3.3. *Let the assumptions of §§3.4.1 and 3.5.1 hold for all r , let Λ° be defined in (3.5.12) and $\widehat{\Lambda} \subset \Lambda^{\circ}$ be given by (3.7.1). Then there exists $\Pi \in I_{\text{comp}}(\Lambda^{\circ})$, uniquely defined modulo $\mathcal{O}(h^{\infty})$ microlocally near $\widehat{\Lambda}$, such that the principal symbol of Π is nonvanishing on $\widehat{\Lambda}$ and, with $P \in \Psi^{\text{comp}}(X)$ defined in Lemma 3.4.3,*

$$\Pi^2 - \Pi = \mathcal{O}(h^{\infty}) \quad \text{microlocally near } \widehat{\Lambda}, \tag{3.7.2}$$

$$[P, \Pi] = \mathcal{O}(h^{\infty}) \quad \text{microlocally near } \widehat{\Lambda}. \tag{3.7.3}$$

Same can be said if we replace $\mathcal{O}(h^{\infty})$ above by $\mathcal{O}(h^N)$, require that the full symbol of Π lies in C^{3N} for some large N (rather than being smooth), and the assumptions of §3.5.1 hold for r large enough depending on N .

Proof. We argue by induction, finding a family Π_k , $k \geq 1$, of microlocal idempotents of all orders near $\widehat{\Lambda}$ (see Definition 3.6.8) such that $[P, \Pi_k] = \mathcal{O}(h^{k+1})$ microlocally near $\widehat{\Lambda}$, and taking their asymptotic limit to obtain Π .

We first construct Π_1 . Take the microlocal idempotent of all orders $\widetilde{\Pi} \in I_{\text{comp}}(\Lambda^{\circ})$ near $\widehat{\Lambda}$ constructed in Proposition 3.6.10. Since the Hamilton field of $p = \sigma(P)$ is tangent to Γ_{\pm} , dp is annihilated by the subbundles \mathcal{V}_{\pm} from §3.5.4; therefore,

$$p(\rho_{\pm}) = p(\pi_{\pm}(\rho_{\pm})), \quad \rho_{\pm} \in \Gamma_{\pm}^{\circ};$$

by (3.6.32) and (3.6.33), $[P, \tilde{\Pi}] = \mathcal{O}(h)$ microlocally near $\widehat{\Lambda}$. We write $[P, \tilde{\Pi}] = hS_0$ microlocally near $\widehat{\Lambda}$, where $S_0 \in I_{\text{comp}}(\Lambda^\circ)$ and by part 4 of Proposition 3.6.9,

$$\sigma_\Lambda(S_0)(\rho_-, \rho_+) = \tilde{a}_0^-(\rho_-) \otimes s_0^+(\rho_+) + s_0^-(\rho_-) \otimes \tilde{a}_0^+(\rho_+), \quad (3.7.4)$$

with $s_0^\pm \in C^\infty(\tilde{\Gamma}_\pm; \mathcal{E}_\pm)$ vanishing on K near \widehat{K} and $\tilde{a}_0^\pm \in C^\infty(\tilde{\Gamma}_\pm; \mathcal{E}_\pm)$ giving the principal symbol of $\tilde{\Pi}$ by (3.6.35). Here $\tilde{\Gamma}_\pm$ are the neighborhoods of $\widehat{\Gamma}_\pm$ in Γ_\pm° defined in (3.6.26).

We look for Π_1 in the form

$$\Pi_1 = e^{Q_0} \tilde{\Pi} e^{-Q_0}, \quad (3.7.5)$$

where $Q_0 \in \Psi^{\text{comp}}(X)$ is compactly supported and thus $e^{\pm Q_0}$ are pseudodifferential (see for example Proposition 2.3.7). We calculate microlocally near $\widehat{\Lambda}$,

$$e^{-Q_0} [P, \Pi_1] e^{Q_0} = [e^{-Q_0} P e^{Q_0}, \tilde{\Pi}] = hS_0 + [[P, Q_0], \tilde{\Pi}] + \mathcal{O}(h^2).$$

Here we use that $e^{-Q_0} P e^{Q_0} = P + [P, Q_0] + \mathcal{O}(h^2)$. By (3.7.4), (3.6.32), (3.6.33),

$$\begin{aligned} & \sigma_\Lambda(S_0 + h^{-1}[[P, Q_0], \tilde{\Pi}])(\rho_-, \rho_+) \\ &= \tilde{a}_0^-(\rho_-) \otimes (s_0^+(\rho_+) - iH_p \sigma(Q_0)(\rho_+) \tilde{a}_0^+(\rho_+)) \\ &+ (s_0^-(\rho_-) + iH_p \sigma(Q_0)(\rho_-) \tilde{a}_0^-(\rho_-)) \otimes \tilde{a}_0^+(\rho_+). \end{aligned}$$

It is thus enough to take any Q_0 such that for the restrictions $q_0^\pm = \sigma(Q_0)|_{\tilde{\Gamma}_\pm}$, the following transport equations hold near $\widehat{\Gamma}_\pm$:

$$H_p q_0^\pm = \mp i s_0^\pm / \tilde{a}_0^\pm, \quad q_0^\pm|_{\widehat{K}} = 0. \quad (3.7.6)$$

Such q_0^\pm exist and are unique and smooth enough by Lemma 3.5.2, giving Π_1 . Note that Lemma 3.5.2 can be applied near $\widehat{\Gamma}_\pm$, instead of the whole Γ_\pm° , since $e^{tH_p}(\widehat{\Gamma}_\pm) \subset \widehat{\Gamma}_\pm$ for $\mp t \geq 0$ by part (2) of Lemma 3.5.1.

Now, assume that we have constructed Π_k for some $k > 0$. Let a_0^\pm be the components of the principal symbol of Π_k given by (3.6.35). Then microlocally near $\widehat{\Lambda}$, $[P, \Pi_k] = h^{k+1} S_k$, where $S_k \in I_{\text{comp}}(\Lambda^\circ)$ and by part 4 of Proposition 3.6.9,

$$\sigma_\Lambda(S_k)(\rho_-, \rho_+) = a_0^-(\rho_-) \otimes s_k^+(\rho_+) + s_k^-(\rho_-) \otimes a_0^+(\rho_+),$$

where $s_k^\pm \in C^\infty(\tilde{\Gamma}_\pm; \mathcal{E}_\pm)$ vanish on K near \widehat{K} . We then take

$$\Pi_{k+1} = (1 + h^k Q_k) \Pi_k (1 + h^k Q_k)^{-1} \quad (3.7.7)$$

where Q_k is a compactly supported pseudodifferential operator. Microlocally near $\widehat{\Lambda}$,

$$[P, \Pi_{k+1}] = h^{k+1} S_k + h^k [[P, Q_k], \Pi_k] + \mathcal{O}(h^{k+2}).$$

Therefore, $q_k^\pm = \sigma(Q_k)|_{\tilde{\Gamma}_\pm}$ need to satisfy the transport equations near $\widehat{\Gamma}_\pm$

$$H_p q_k^\pm = \mp i s_k^\pm / a_0^\pm, \quad q_k^\pm|_{\widehat{K}} = 0. \quad (3.7.8)$$

Such q_k^\pm exist and are unique and smooth enough again by Lemma 3.5.2, giving Π_{k+1} .

To show that the operator Π satisfying (3.7.2) and (3.7.3) is unique microlocally near $\widehat{\Lambda}$, we show by induction that each such Π satisfies $\Pi = \Pi_k + \mathcal{O}(h^k)$ microlocally near $\widehat{\Lambda}$. First of all, Π has the form (3.7.5) for some operator Q_0 microlocally near $\widehat{\Lambda}$, by part 2 of Proposition 3.6.9; moreover, by the proof of this fact, we can take $\sigma(Q_0)|_K = 0$ near \widehat{K} . Now, $\sigma(Q_0)|_{\widehat{\Gamma}_\pm}$ are determined uniquely by the transport equations (3.7.6), and this gives $\Pi = \Pi_1 + \mathcal{O}(h)$ microlocally near $\widehat{\Lambda}$. Next, if $\Pi = \Pi_k + \mathcal{O}(h^k)$ for some $k > 0$, then, as follows from the proof of Part 2 of Proposition 3.6.9, Π has the form (3.7.7) for some operator Q_k microlocally near $\widehat{\Lambda}$, such that $\sigma(Q_k)|_K = 0$ near \widehat{K} . Then $\sigma(Q_k)|_{\widehat{\Gamma}_\pm}$ are determined uniquely by the transport equations (3.7.8), and this gives $\Pi = \Pi_{k+1} + \mathcal{O}(h^{k+1})$ microlocally near $\widehat{\Lambda}$. \square

3.7.2 Annihilating ideals

Let $\Pi \in I_{\text{comp}}(\Lambda^\circ)$ be the operator constructed in Theorem 3.3. In this section, we construct pseudodifferential operators Θ_\pm annihilating Π microlocally near $\widehat{\Lambda}$; they are key for the microlocal estimates in §3.8. More precisely, we obtain

Proposition 3.7.1. *If $\delta > 0$ in the definition (3.7.1) of \widehat{W} is small enough, then there exist compactly supported $\Theta_\pm \in \Psi^{\text{comp}}(X)$ such that:*

- (1) $\Pi\Theta_- = \mathcal{O}(h^\infty)$ and $\Theta_+\Pi = \mathcal{O}(h^\infty)$ microlocally near $\widehat{\Lambda}$;
- (2) $\sigma(\Theta_\pm) = \varphi_\pm$ near \widehat{W} , with φ_\pm defined in Lemma 3.5.1;
- (3) if P is the operator constructed in Lemma 3.4.3, then

$$[P, \Theta_-] = -ih\Theta_-Z_- + \mathcal{O}(h^\infty), \quad [P, \Theta_+] = ihZ_+\Theta_+ + \mathcal{O}(h^\infty) \quad (3.7.9)$$

microlocally near \widehat{W} , where $Z_\pm \in \Psi^{\text{comp}}(X)$ are compactly supported and $\sigma(Z_\pm) = c_\pm$ near \widehat{W} , with c_\pm defined in Lemma 3.5.1;

- (4) if $\text{Im } \Theta_+ = \frac{1}{2i}(\Theta_+ - \Theta_+^*)$ and $\zeta = \sigma(h^{-1}\text{Im } \Theta_+)$, then

$$H_p\zeta = -c_+\zeta - \frac{1}{2}\{\varphi_+, c_+\} \quad \text{on } \Gamma_+ \text{ near } \widehat{W}; \quad (3.7.10)$$

- (5) there exists an operator $\Xi : C^\infty(X) \rightarrow C_0^\infty(X)$, satisfying parts 1 and 2 of Proposition 3.6.13 and such that

$$1 - \Pi = \Theta_- \Xi + \mathcal{O}(h^\infty) \quad \text{microlocally near } \widehat{W} \times \widehat{W}. \quad (3.7.11)$$

Proof. The operators Θ_{\pm} satisfying conditions (1) and (2) exist by part 1 of Proposition 3.6.11. Next, since $[P, \Pi] = \mathcal{O}(h^{\infty})$ microlocally near $\widehat{\Lambda}$, we find

$$\Pi[P, \Theta_{-}] = \mathcal{O}(h^{\infty}), \quad [P, \Theta_{+}]\Pi = \mathcal{O}(h^{\infty})$$

microlocally near $\widehat{\Lambda}$; condition (3) now follows from part 2 of Proposition 3.6.11. The symbols $\sigma(Z_{\pm})$ can be computed using the identity $H_p\varphi_{\pm} = \mp c_{\pm}\varphi_{\pm}$ from part (2) of Lemma 3.5.1. Condition (5) follows immediately from Proposition 3.6.13, keeping in mind that by making δ small we can make \widehat{W} contained in an arbitrary neighborhood of \widehat{K} .

Finally, we verify condition (4). Taking the adjoint of the identity $[P, \Theta_{+}] = ihZ_{+}\Theta_{+} + \mathcal{O}(h^{\infty})$ and using that P is self-adjoint, we get microlocally near \widehat{W} ,

$$[P, \Theta_{+}^{*}] = ih\Theta_{+}^{*}Z_{+}^{*}.$$

Therefore, microlocally near \widehat{W}

$$2[P, h^{-1}\text{Im}\Theta_{+}] = Z_{+}\Theta_{+} - \Theta_{+}^{*}Z_{+}^{*} = [Z_{+}, \Theta_{+}] + 2i((\text{Im}\Theta_{+})Z_{+}^{*} + \Theta_{+}\text{Im}Z_{+}).$$

By comparing the principal symbols, we get (3.7.10). \square

3.8 Resolvent estimates

In this section we give various estimates on the resolvent $\mathcal{R}(\omega)$, in particular proving Theorem 3.1. In §3.8.1, we reduce Theorem 3.1 to a microlocal estimate in a neighborhood of the trapped set, which is further split into two estimates: on the kernel of the projector Π given by Theorem 3.3, proved in §3.8.2, and on the image of Π , proved in §3.8.3. In §3.8.4 we obtain a restriction on the wavefront set $\mathcal{R}(\omega)$ in ω on the image of Π , needed in §3.10. Finally, in §3.8.5, we discuss the consequences of our methods for microlocal concentration of resonant states and the corresponding semiclassical measures.

3.8.1 Reduction to the trapped set

We take $\delta > 0$ small enough so that the results of §3.7.1, 3.7.2 hold, and define following (3.7.1) (with δ_1 chosen in §3.5.4),

$$\widehat{W} := U_{\delta} \cap p^{-1}([\alpha_0 - \delta_1/2, \alpha_1 + \delta_1/2]), \quad W' := U_{\delta/2} \cap p^{-1}([\alpha_0 - \delta_1/4, \alpha_1 + \delta_1/4]), \quad (3.8.1)$$

so that W' is a neighborhood of $K \cap p^{-1}([\alpha_0, \alpha_1])$ compactly contained in \widehat{W} . Here U_{δ} is defined in (3.5.8).

For the reductions of this subsection, it is enough to assume that ω satisfies (3.4.1). The region (3.1.5) will arise as the intersection of the regions (3.8.9) and (3.8.11) where the two components of the estimate will hold.

To prove Theorem 3.1, it is enough to show the estimate

$$\|\tilde{u}\|_{\mathcal{H}_1} \leq Ch^{-2}\|\tilde{f}\|_{\mathcal{H}_2} + \mathcal{O}(h^\infty) \quad (3.8.2)$$

for each $\tilde{u} = \tilde{u}(h) \in \mathcal{H}_1$ with $\|\tilde{u}\|_{\mathcal{H}_1}$ bounded polynomially in h and for $\tilde{f} = \mathcal{P}(\omega)\tilde{u}$, where $\omega = \omega(h)$ satisfies (3.1.5).

Subtracting from \tilde{u} the function v constructed in Lemma 3.4.5, we may assume that

$$\text{WF}_h(\tilde{f}) \subset W'.$$

Let $\mathcal{S}(\omega)$ be the operator constructed in Lemma 3.4.3, $\mathcal{S}'(\omega)$ be its elliptic parametrix near $\mathcal{U} \supset \widehat{W}$ constructed in Lemma 3.3.3, and put

$$u := \mathcal{S}(\omega)\tilde{u}, \quad f := \mathcal{S}'(\omega)\tilde{f},$$

so by (3.4.9), for the operator P constructed in Lemma 3.4.3,

$$(P - \omega)u = f \quad \text{microlocally near } \widehat{W}, \quad \text{WF}_h(f) \subset \widehat{W}. \quad (3.8.3)$$

By ellipticity (Proposition 3.3.2) and since $\text{WF}_h(f) \subset W'$,

$$\text{WF}_h(u) \cap \widehat{W} \subset p^{-1}([\alpha_0 - \delta_1/4, \alpha_1 + \delta_1/4]). \quad (3.8.4)$$

Let φ_\pm be the functions constructed in Lemma 3.5.1. By Lemma 3.4.4, u satisfies the conditions (see Figure 3.5)

$$\text{WF}_h(u) \cap \widehat{W} \subset \{|\varphi_+| \leq \delta/2\}, \quad (3.8.5)$$

$$\text{WF}_h(u) \cap \Gamma_- \subset W'. \quad (3.8.6)$$

Indeed, if $\rho \in \text{WF}_h(u) \cap \mathcal{U}$, then either $\rho \in \Gamma_+$ (in which case (3.8.5) and (3.8.6) follow immediately) or there exists $T \geq 0$ such that for $\gamma(t) = e^{tH_p}(\rho)$, $\gamma([-T, 0]) \subset \widehat{U}$ and $\gamma(-T) \in \text{WF}_h(\tilde{f}) \subset W'$. In the second case, if $\rho \in \widehat{W}$, then by convexity of U_δ (part (5) of Lemma 3.5.1) we have $\gamma([-T, 0]) \subset \widehat{W}$. To show (3.8.5), it remains to use that $H_p\varphi_+^2 \leq 0$ on \widehat{W} , following from part (2) of Lemma 3.5.1. For (3.8.6), note that if $\rho \in \Gamma_-$, then $\gamma(-T) \in \Gamma_- \cap W'$; however, $e^{tH_p}(\Gamma_- \cap W') \subset \Gamma_- \cap W'$ for all $t \geq 0$ and thus $\rho \in W'$.

By Lemma 3.4.6, we reduce (3.8.2) to

$$\|A_1u\|_{L^2} \leq Ch^{-2}\|f\|_{L^2} + \mathcal{O}(h^\infty), \quad (3.8.7)$$

where $A_1 \in \Psi^{\text{comp}}(X)$ is any compactly supported operator elliptic on W' .

Now, let $\Pi \in I_{\text{comp}}(\Lambda^\circ)$ be the operator constructed in Theorem 3.3 in §3.7.1. Note that

$$(P - \omega)\Pi u = \Pi f + \mathcal{O}(h^\infty) \quad \text{microlocally near } \widehat{W}, \quad (3.8.8)$$

since $[P, \Pi] = \mathcal{O}(h^\infty)$ microlocally near $\widehat{W} \times \widehat{W}$, $\text{WF}_h(\Pi) \subset \Lambda^\circ \subset \Gamma_-^\circ \times \Gamma_+^\circ$, and by (3.8.6).

We finally reduce (3.8.7) to the following two estimates, which are proved in the following subsections:

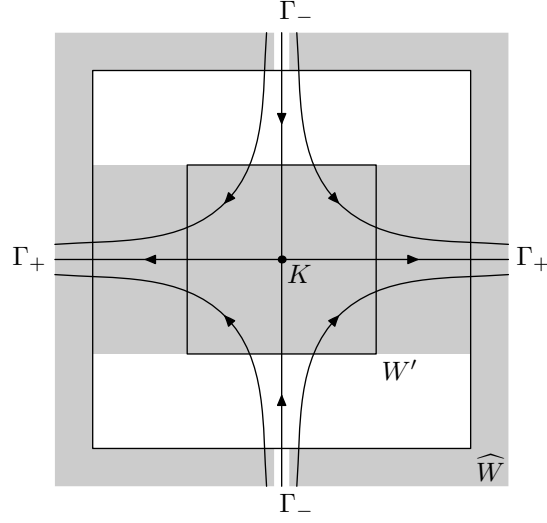

Figure 3.5: A phase space picture of the geodesic flow near \widehat{W} . The shaded region corresponds to (3.8.5) and (3.8.6).

Proposition 3.8.1. *Assume that u, f are h -tempered families satisfying (3.8.3)–(3.8.6) and*

$$\operatorname{Re} \omega \in [\alpha_0, \alpha_1], \quad \operatorname{Im} \omega \in [-(\nu_{\min} - \varepsilon)h, C_0h]. \quad (3.8.9)$$

Then there exists compactly supported $A_1 \in \Psi^{\text{comp}}(X)$ elliptic on W' such that

$$\|A_1(1 - \Pi)u\|_{L^2} \leq Ch^{-1}\|\Xi f\|_{L^2} + \mathcal{O}(h^\infty), \quad (3.8.10)$$

where Ξ is the operator from part (5) of Proposition 3.7.1; note that by part 1 of Proposition 3.6.13, $\|\Xi\|_{L^2 \rightarrow L^2} = \mathcal{O}(h^{-1})$.

Proposition 3.8.2. *Assume that u, f are h -tempered families satisfying (3.8.3)–(3.8.6) and*

$$\operatorname{Re} \omega \in [\alpha_0, \alpha_1], \quad \operatorname{Im} \omega \in [-C_0h, C_0h] \setminus \left(-\frac{\nu_{\max} + \varepsilon}{2}h, -\frac{\nu_{\min} - \varepsilon}{2}h \right), \quad (3.8.11)$$

Then there exists compactly supported $A_1 \in \Psi^{\text{comp}}(X)$ elliptic on W' such that

$$\|A_1\Pi u\|_{L^2} \leq Ch^{-1}\|\Pi f\|_{L^2} + \mathcal{O}(h^\infty). \quad (3.8.12)$$

Note that by Proposition 3.6.1 and the reduction to the model case of §3.6.2, we have $\|\Pi\|_{L^2 \rightarrow L^2} = \mathcal{O}(h^{-1/2})$.

3.8.2 Estimate on the kernel of Π

In this section, we prove Proposition 3.8.1, which is a microlocal estimate on the kernel of Π (or equivalently, on the image of $1 - \Pi$). We will use the identity (3.7.11) together with the commutator formula (3.7.9) to effectively shift the spectral parameter to the upper half-plane, where a standard positive commutator argument gives us the estimate.

By (3.8.8), we have microlocally near \widehat{W} ,

$$(P - \omega)(1 - \Pi)u = (1 - \Pi)f + \mathcal{O}(h^\infty) \quad (3.8.13)$$

Let $\Theta_- \in \Psi^{\text{comp}}(X)$ and Ξ be the operators constructed in Proposition 3.7.1, and denote

$$v := \Xi u, \quad g := \Xi f.$$

Then microlocally near \widehat{W} ,

$$(1 - \Pi)u = \Theta_- v, \quad (1 - \Pi)f = \Theta_- g. \quad (3.8.14)$$

Indeed, by part 2 of Proposition 3.6.13, (3.8.6), and the fact that $\text{WF}_h(\Pi) \subset \Lambda^\circ \subset \Gamma_-^\circ \times \Gamma_+^\circ$, we see that $1 - \Pi = \Theta_- \Xi + \mathcal{O}(h^\infty)$ microlocally near $(\text{WF}_h(u) \setminus \widehat{W}) \times \widehat{W}$, since each of the featured operators is microlocalized away from this region. Combining this with (3.7.11), we see that $1 - \Pi = \Theta_- \Xi + \mathcal{O}(h^\infty)$ microlocally near $\text{WF}_h(u) \times \widehat{W}$, and thus also near $\text{WF}_h(f) \times \widehat{W}$, yielding (3.8.14).

By part 2 of Proposition 3.6.13 together with (3.8.4)–(3.8.6) and part (4) of Lemma 3.5.1,

$$\text{WF}_h(v) \cup \text{WF}_h(g) \subset p^{-1}([\alpha_0 - \delta_1/4, \alpha_1 + \delta_1/4]), \quad (3.8.15)$$

$$(\text{WF}_h(v) \cup \text{WF}_h(g)) \cap \widehat{W} \subset \{|\varphi_+| \leq \delta/2\}. \quad (3.8.16)$$

We now obtain a differential equation on v ; the favorable imaginary part of the operator in this equation, coming from commuting Θ_- with P , is the key component of the proof.

Proposition 3.8.3. *Let Z_- be the operator from (3.7.9). Then microlocally near \widehat{W} ,*

$$(P - ihZ_- - \omega)v = g + \mathcal{O}(h^\infty). \quad (3.8.17)$$

Proof. Given (3.8.14), the equation (3.8.13) becomes $(P - \omega)\Theta_- v = \Theta_- g + \mathcal{O}(h^\infty)$ microlocally near \widehat{W} . Using (3.7.9), we get microlocally near \widehat{W} ,

$$\Theta_-(P - ihZ_- - \omega)v = \Theta_- g + \mathcal{O}(h^\infty).$$

To show (3.8.17), it remains to apply propagation of singularities (part 2 of Proposition 3.3.4), for the operator Θ_- . Indeed, by part (4) of Lemma 3.5.1, for each $\rho \in \widehat{W}$, there exists $t \geq 0$ such that the Hamiltonian trajectory $\{e^{sH_{\varphi_-}}(\rho) \mid 0 \leq s \leq t\}$ lies entirely inside \widehat{W} and $e^{tH_{\varphi_-}}(\rho)$ lies in $\{\varphi_+ = -\delta\}$ and by (3.8.16) does not lie in $\text{WF}_h((P - ihZ_- - \omega)v - \Theta_- g)$. \square

We now use a positive commutator argument. Take a self-adjoint compactly supported $\mathcal{X}_- \in \Psi^{\text{comp}}(X)$ such that $\text{WF}_h(\mathcal{X}_-)$ is compactly contained in \widehat{W} and $\sigma(\mathcal{X}_-) = \chi(\varphi_-)$ near $\widehat{W} \cap \text{WF}_h(v)$, where φ_- is defined in Lemma 3.5.1, $\chi \in C_0^\infty(-\delta, \delta)$, $s\chi'(s) \leq 0$ everywhere, and $\chi = 1$ near $[-\delta/2, \delta/2]$. This is possible by (3.8.15) and (3.8.16). Put $\text{Im } \omega = h\nu$; by (3.8.17) and since P is self-adjoint,

$$\begin{aligned} \text{Im}\langle \mathcal{X}_- v, g \rangle &= \frac{h}{2} \langle (Z_-^* \mathcal{X}_- + \mathcal{X}_- Z_- + 2\nu \mathcal{X}_-) v, v \rangle \\ &+ \frac{1}{2i} \langle [P, \mathcal{X}_-] v, v \rangle + \mathcal{O}(h^\infty) = h \langle \mathcal{Y}_- v, v \rangle + \mathcal{O}(h^\infty), \end{aligned} \quad (3.8.18)$$

where $\mathcal{Y}_- \in \Psi^{\text{comp}}(X)$ is compactly supported, $\text{WF}_h(\mathcal{Y}_-) \subset \text{WF}_h(\mathcal{X}_-) \subset \widehat{W}$ and, using the function c_- from part (2) of Lemma 3.5.1 together with part (3) of Proposition 3.7.1, we write near $\widehat{W} \cap \text{WF}_h(v)$,

$$\sigma(\mathcal{Y}_-) = (c_- + \nu)\chi(\varphi_-) - \frac{1}{2}H_p\chi(\varphi_-) = (c_- + \nu)\chi(\varphi_-) - \frac{1}{2}c_- \varphi_- \chi'(\varphi_-).$$

However, $\nu \geq -(\nu_{\min} - \varepsilon)$ by (3.8.9) and by (3.5.9), $c_- > (\nu_{\min} - \varepsilon)$ on \widehat{W} ; therefore

$$\sigma(\mathcal{Y}_-) \geq 0 \quad \text{near } \text{WF}_h(v), \quad \sigma(\mathcal{Y}_-) > 0 \quad \text{near } \text{WF}_h(v) \cap W'. \quad (3.8.19)$$

To take advantage of (3.8.19), we use the following combination of sharp Gårding inequality with propagation of singularities:

Lemma 3.8.4. *Assume that $Z, Q \in \Psi^{\text{comp}}(X)$ are compactly supported, $\text{WF}_h(Z), \text{WF}_h(Q)$ are compactly contained in \widehat{W} , $Z^* = Z$, and*

$$\sigma(Z) \geq 0 \quad \text{near } \text{WF}_h(v), \quad \sigma(Z) > 0 \quad \text{near } \text{WF}_h(v) \cap W'.$$

Then

$$\|Qv\|_{L^2}^2 \leq C \langle Zv, v \rangle + Ch^{-2} \|g\|_{L^2}^2 + \mathcal{O}(h^\infty). \quad (3.8.20)$$

Proof. Without loss of generality, we may assume that Q is elliptic on $\text{WF}_h(Z) \cup W'$. There exists compactly supported $Q_1 \in \Psi^{\text{comp}}(X)$, elliptic on W' , such that $\sigma(Z - Q_1^* Q_1) \geq 0$ near $\text{WF}_h(v)$ and Q is elliptic on $\text{WF}_h(Q_1)$. Applying sharp Gårding inequality (Proposition 3.3.6) to $Z - Q_1^* Q_1$, we get

$$\|Q_1 v\|_{L^2}^2 \leq C \langle Zv, v \rangle + Ch \|Qv\|_{L^2}^2 + \mathcal{O}(h^\infty). \quad (3.8.21)$$

Now, by (3.8.15), (3.8.16), and since $H_p \varphi_-^2 > 0$ on $\widehat{W} \setminus \Gamma_-$ by part (2) of Lemma 3.5.1, each backwards flow line of H_p starting on $\text{WF}_h(Q)$ reaches either $\text{WF}_h(Q_1)$ or the complement of $\text{WF}_h(v)$, while staying in \widehat{W} ; by propagation of singularities (Proposition 3.3.4) applied to (3.8.17),

$$\|Qv\|_{L^2} \leq C \|Q_1 v\|_{L^2} + Ch^{-1} \|g\|_{L^2} + \mathcal{O}(h^\infty). \quad (3.8.22)$$

Combining (3.8.21) and (3.8.22), we get (3.8.20). \square

Now, there exists $A_1 \in \Psi^{\text{comp}}(X)$ compactly supported, elliptic on W' and with $\text{WF}_h(A_1)$ compactly contained in \widehat{W} , such that the estimate

$$|\langle \mathcal{X}_- v, g \rangle| \leq \tilde{\varepsilon} h \|A_1 v\|_{L^2}^2 + C_{\tilde{\varepsilon}} h^{-1} \|g\|_{L^2}^2 + \mathcal{O}(h^\infty) \quad (3.8.23)$$

holds for each $\tilde{\varepsilon} > 0$ and constant $C_{\tilde{\varepsilon}}$ dependent on $\tilde{\varepsilon}$. Taking $\tilde{\varepsilon}$ small enough and combining (3.8.18), (3.8.20) (for $Z = \mathcal{Y}_-$ and $Q = A_1$), and (3.8.23), we arrive to

$$\|A_1 v\|_{L^2} \leq C h^{-1} \|g\|_{L^2} + \mathcal{O}(h^\infty).$$

Since $(1 - \Pi)u = \Theta_- v$ microlocally near \widehat{W} , we get (3.8.10).

3.8.3 Estimate on the image of Π

In this section, we prove Proposition 3.8.2, which is a microlocal estimate on the image of Π . We will use the pseudodifferential operator Θ_+ microlocally solving $\Theta_+ \Pi = \mathcal{O}(h^\infty)$ to obtain an additional pseudodifferential equation satisfied by elements of the image of Π . This will imply that for a pseudodifferential operator A microlocalized near K , the principal part of the expression $\langle A \Pi u(h), \Pi u(h) \rangle$ depends only on the integral of $\sigma(A)$ over the flow lines of \mathcal{V}_+ , with respect to an appropriately chosen measure. A positive commutator estimate finishes the proof.

By (3.8.8), we have microlocally near \widehat{W} ,

$$(P - \omega) \Pi u = \Pi f + \mathcal{O}(h^\infty). \quad (3.8.24)$$

Let $\Theta_+ \in \Psi^{\text{comp}}(X)$ be the operator constructed in Proposition 3.7.1, then by (3.8.6),

$$\Theta_+ \Pi u = \mathcal{O}(h^\infty) \quad \text{microlocally near } \widehat{W}. \quad (3.8.25)$$

We start with

Lemma 3.8.5. *Let $\zeta := \sigma(h^{-1} \text{Im } \Theta_+)$. Take the function ψ on $\Gamma_+ \cap \widehat{W}$ such that*

$$\{\varphi_+, \psi\} = 2\zeta, \quad \psi|_K = 0. \quad (3.8.26)$$

Assume that $A \in \Psi^{\text{comp}}(X)$ satisfies $\text{WF}_h(A) \Subset \widehat{W}$ and

$$\int (e^\psi \sigma(A)) \circ e^{sH_{\varphi_+}} ds = 0 \quad \text{on } K. \quad (3.8.27)$$

The integral in (3.8.27), and all similar integrals in this subsection, is taken over the interval corresponding to a maximally extended flow line of H_{φ_+} in $\Gamma_+ \cap \widehat{W}$.

Then there exists compactly supported $A_0 \in \Psi^{\text{comp}}(X)$ with $\text{WF}_h(A_0) \Subset \widehat{W}$ such that

$$|\langle A \Pi u, \Pi u \rangle| \leq C h \|A_0 \Pi u\|_{L^2}^2 + \mathcal{O}(h^\infty).$$

Proof. By (3.8.27), there exists $q \in C_0^\infty(\widehat{W})$ such that $\{\varphi_+, e^\psi q\} = e^\psi \sigma(A)$ on Γ_+ . We can rewrite this as

$$\{\varphi_+, q\} + 2\zeta q = \sigma(A) \quad \text{on } \Gamma_+. \quad (3.8.28)$$

Take $Q, Y \in \Psi^{\text{comp}}(X)$ microlocalized inside \widehat{W} and such that $\sigma(Q) = q$ and

$$\sigma(A) = \{\varphi_+, q\} + 2\zeta q + \sigma(Y)\varphi_+.$$

Then $A = (ih)^{-1}(Q\Theta_+ - \Theta_+^*Q) + Y\Theta_+ + \mathcal{O}(h)_{\Psi^{\text{comp}}}$ and thus for some A_0 ,

$$\begin{aligned} \langle A\Pi u, \Pi u \rangle &= \frac{\langle Q\Theta_+\Pi u, \Pi u \rangle - \langle Q\Pi u, \Theta_+\Pi u \rangle}{ih} + \langle Y\Theta_+\Pi u, \Pi u \rangle \\ &\quad + \mathcal{O}(h)\|A_0\Pi u\|_{L^2}^2 + \mathcal{O}(h^\infty). \end{aligned}$$

The first three terms on the right-hand side are $\mathcal{O}(h^\infty)$ by (3.8.25). \square

Now, take compactly supported self-adjoint $\mathcal{X}_+ \in \Psi^{\text{comp}}(X)$ such that $\text{WF}_h(\mathcal{X}_+)$ is compactly contained in \widehat{W} and the symbol $\chi_+ := \sigma(\mathcal{X}_+)$ satisfies $\chi_+ \geq 0$ everywhere, $\chi_+ > 0$ on W' , and

$$\int (e^\psi \chi_+) \circ e^{sH_{\varphi_+}} ds = 1 \quad \text{on } K \cap p^{-1}([\alpha_0 - \delta_1/4, \alpha_1 + \delta_1/4]). \quad (3.8.29)$$

Putting $\text{Im } \omega = h\nu$, we have by (3.8.24)

$$\begin{aligned} \text{Im} \langle \mathcal{X}_+\Pi u, \Pi f \rangle &= h\nu \langle \mathcal{X}_+\Pi u, \Pi u \rangle + \frac{1}{2i} \langle [P, \mathcal{X}_+]\Pi u, \Pi u \rangle + \mathcal{O}(h^\infty) \\ &= h \langle \mathcal{Y}_+\Pi u, \Pi u \rangle + \mathcal{O}(h^\infty), \end{aligned} \quad (3.8.30)$$

where $\mathcal{Y}_+ \in \Psi^{\text{comp}}(X)$ is compactly supported, $\text{WF}_h(\mathcal{Y}_+) \subset \text{WF}_h(\mathcal{X}_+) \subset \widehat{W}$, and

$$\sigma(\mathcal{Y}_+) = \nu\chi_+ - H_p\chi_+/2.$$

We now want to use Lemma 3.8.5 together with Gårding inequality to show that $\langle \mathcal{Y}_+\Pi u, \Pi u \rangle$ has fixed sign, positive for $\nu \geq -(\nu_{\min} - \varepsilon)/2$ and negative for $\nu \leq -(\nu_{\max} + \varepsilon)/2$. For that, we need to integrate $\sigma(\mathcal{Y}_+)$ over the Hamiltonian flow lines of φ_+ on Γ_+ , with respect to the measure from (3.8.27). This relies on

Lemma 3.8.6. *If c_+ is defined in Lemma 3.5.1, then*

$$\int (e^\psi H_p\chi_+) \circ e^{sH_{\varphi_+}} ds = -c_+ \quad \text{on } K \cap p^{-1}([\alpha_0 - \delta_1/4, \alpha_1 + \delta_1/4]). \quad (3.8.31)$$

Proof. By part (2) of Lemma 3.5.1, we have on $\Gamma_+ \cap \widehat{W}$

$$(e^{sH_{\varphi_+}})_* \partial_s (e^{-sH_{\varphi_+}})_* H_p = -[H_p, H_{\varphi_+}] = c_+ H_{\varphi_+}.$$

Therefore, we can write (at $\rho \in K$ and s such that $e^{sH_{\varphi_+}}(\rho) \in \widehat{W}$)

$$(e^{-sH_{\varphi_+}})_* H_p = H_p + w(s) H_{\varphi_+} \quad \text{on } K$$

where $w(s)$ is the smooth function on $K \times \mathbb{R}$ given by

$$\partial_s w(s) = c_+ \circ e^{sH_{\varphi_+}}, \quad w(0) = 0.$$

Now, differentiating (3.8.29) along H_p and integrating by parts, we have on $K \cap p^{-1}([\alpha_0 - \delta_1/4, \alpha_1 + \delta_1/4])$

$$\begin{aligned} \int (H_p(e^\psi \chi_+)) \circ e^{sH_{\varphi_+}} ds &= \int (H_p + w(s) \partial_s) ((e^\psi \chi_+) \circ e^{sH_{\varphi_+}}) ds \\ &= - \int (e^\psi c_+ \chi_+) \circ e^{sH_{\varphi_+}} ds; \end{aligned}$$

therefore,

$$\int (e^\psi H_p \chi_+) \circ e^{sH_{\varphi_+}} ds = - \int (e^\psi (c_+ + H_p \psi) \chi_+) \circ e^{sH_{\varphi_+}} ds. \quad (3.8.32)$$

Now, we find on $\Gamma_+ \cap \widehat{W}$ by (3.8.26) and (3.7.10),

$$H_{\varphi_+} H_p \psi = (H_p + c_+) H_{\varphi_+} \psi = 2(H_p + c_+) \zeta = -H_{\varphi_+} c_+.$$

We have on $K \cap \widehat{W}$, $H_p \psi = 0$; thus

$$c_+ + H_p \psi = c_+ \circ \pi_+ \quad \text{on } \Gamma_+ \cap \widehat{W}$$

and by (3.8.32) and (3.8.29), on $K \cap p^{-1}([\alpha_0 - \delta_1/4, \alpha_1 + \delta_1/4])$,

$$\int (e^\psi H_p \chi_+) \circ e^{sH_{\varphi_+}} ds = -c_+ \int (e^\psi \chi_+) \circ e^{sH_{\varphi_+}} ds = -c_+.$$

This finishes the proof of (3.8.31). \square

Using (3.8.29), (3.8.31), and Lemma 3.8.5 (taking into account (3.8.4)), we find for some compactly supported $A_1 \in \Psi^{\text{comp}}$ with $\text{WF}_h(A_1) \subset \widehat{W}$ and A_1 elliptic on $W' \cup \text{WF}_h(\mathcal{X}_+)$,

$$\langle \mathcal{Y}_+ \Pi u, \Pi u \rangle = \langle \mathcal{Z}_+ \Pi u, \Pi u \rangle + \mathcal{O}(h) \|A_1 \Pi u\|_{L^2}^2 + \mathcal{O}(h^\infty)$$

where $\mathcal{Z}_+ \in \Psi^{\text{comp}}(X)$ is any self-adjoint compactly supported operator with $\text{WF}_h(\mathcal{Z}_+) \subset \widehat{W}$ and

$$\sigma(\mathcal{Z}_+) = (\nu + (c_+ \circ \pi_+)/2) \chi_+ \quad \text{on } \Gamma_+.$$

Then by (3.8.30),

$$\operatorname{Im}\langle \mathcal{X}_+\Pi u, \Pi f \rangle = h\langle \mathcal{Z}_+\Pi u, \Pi u \rangle + \mathcal{O}(h^2)\|A_1\Pi u\|_{L^2}^2 + \mathcal{O}(h^\infty). \quad (3.8.33)$$

Now, by (3.5.9), $\nu_{\min} - \varepsilon < c_+ < \nu_{\max} + \varepsilon$ on K , therefore, keeping in mind that $\operatorname{WF}_h(\Pi u) \subset \Gamma_+^\circ$, we find

$$\sigma(\mathcal{Z}_+) \geq 0 \quad \text{near } \operatorname{WF}_h(\Pi u) \quad \text{for } \nu \geq -(\nu_{\min} - \varepsilon)/2, \quad (3.8.34)$$

$$\sigma(\mathcal{Z}_+) \leq 0 \quad \text{near } \operatorname{WF}_h(\Pi u) \quad \text{for } \nu \leq -(\nu_{\max} + \varepsilon)/2. \quad (3.8.35)$$

Moreover, in both cases $\sigma(\mathcal{Z}_+) \neq 0$ on $\operatorname{WF}_h(\Pi u) \cap W'$. We now combine sharp Gårding inequality and propagation of singularities for the operator Θ_+ :

Lemma 3.8.7. *Assume that $Z, Q \in \Psi^{\operatorname{comp}}(X)$ are compactly supported, $\operatorname{WF}_h(Z), \operatorname{WF}_h(Q)$ are compactly contained in \widehat{W} , $Z^* = Z$, and*

$$\sigma(Z) \geq 0 \quad \text{near } \operatorname{WF}_h(\Pi u), \quad \sigma(Z) > 0 \quad \text{near } \operatorname{WF}_h(\Pi u) \cap W'.$$

Then

$$\|Q\Pi u\|_{L^2}^2 \leq C\langle Z\Pi u, \Pi u \rangle + \mathcal{O}(h^\infty). \quad (3.8.36)$$

Proof. We argue similarly to the proof of Lemma 3.8.4, with (3.8.22) replaced by

$$\|Q\Pi u\|_{L^2} \leq C\|Q_1\Pi u\|_{L^2} + \mathcal{O}(h^\infty). \quad (3.8.37)$$

The estimate (3.8.37) follows from propagation of singularities (Proposition 3.3.4) applied to (3.8.25). Indeed, by part (4) of Lemma 3.5.1 together with (3.8.4), for each $\rho \in \widehat{W} \cap \operatorname{WF}_h(\Pi u) \subset \Gamma_+$, there exists $t \in \mathbb{R}$ such that $e^{tH_{\varphi_+}}(\rho) \in W'$ and $e^{sH_{\varphi_+}}(\rho) \in \widehat{W}$ for each s between 0 and t . \square

Using (3.8.36) (for $Z = \pm\mathcal{Z}_+, Q = A_1$), (3.8.33), and an analog of (3.8.23), we complete the proof of (3.8.12).

3.8.4 Microlocalization in the spectral parameter

In this section, we provide a restriction on the wavefront set of solutions to the equation $(P - \omega)u = f$ in the spectral parameter ω , needed in §3.10. We use the method of §3.8.3, however since $\operatorname{Re}\omega$ is now a variable, we will get an extra term coming from commutation with the multiplication operator by ω . Because of the technical difficulties of studying operators on product spaces (namely, a pseudodifferential operator on X does not give rise to a pseudodifferential operator on $X \times (\alpha_0, \alpha_1)$ since the corresponding symbol does not decay under differentiation in ξ and thus does not lie in the class S^k of §3.3.1), we use the Fourier transform in the ω variable.

Proposition 3.8.8. Fix $\nu \in [-C_0, C_0]$ and put $\omega = \alpha + ih\nu$, where $\alpha \in (\alpha_0, \alpha_1)$ is regarded as a variable. Assume that $u(x, \alpha; h) \in C([\alpha_0, \alpha_1]; \mathcal{H}_1)$, $f(x, \alpha; h) \in C([\alpha_0, \alpha_1]; \mathcal{H}_2)$ have norms bounded polynomially in h , satisfying (3.8.3)–(3.8.6) uniformly in α . Define the semiclassical Fourier transform

$$\hat{u}(x, s; h) = \int_{\alpha_0}^{\alpha_1} e^{-\frac{is\alpha}{h}} u(x, \alpha; h) d\alpha, \quad (3.8.38)$$

and $\hat{f}(x, s; h)$ accordingly. Then there exists $A_1 \in \Psi^{\text{comp}}(X)$ elliptic on W' such that:

1. If $\nu \geq -(\nu_{\min} - \varepsilon)/2$, then for any fixed $s_0 \in \mathbb{R}$,

$$\|\Pi \hat{f}\|_{L_s^2((-\infty, s_0])L_x^2(X)} = \mathcal{O}(h^\infty) \implies \|A_1 \Pi \hat{u}(s_0)\|_{L_x^2(X)} = \mathcal{O}(h^\infty). \quad (3.8.39)$$

2. If $\nu \leq -(\nu_{\max} + \varepsilon)/2$, then for any fixed $s_0 \in \mathbb{R}$,

$$\|\Pi \hat{f}\|_{L_s^2([s_0, \infty))L_x^2(X)} = \mathcal{O}(h^\infty) \implies \|A_1 \Pi \hat{u}(s_0)\|_{L_x^2(X)} = \mathcal{O}(h^\infty). \quad (3.8.40)$$

Proof. We consider case 1; case 2 is handled similarly using (3.8.35) instead of (3.8.34). Since $u(\alpha), f(\alpha)$ are h -tempered uniformly in α , their Fourier transforms $\hat{u}(s), \hat{f}(s)$ are h -tempered and satisfy (3.8.3)–(3.8.6) in the L^2 sense in s ; therefore, the corresponding $\mathcal{O}(h^\infty)$ errors will be bounded in L_s^2 for expressions linear in \hat{u}, \hat{f} and in L_s^1 for expressions quadratic in \hat{u}, \hat{f} . We also note that for each j , the derivatives $\partial_s^j \hat{u}(s), \partial_s^j \hat{f}(s)$ are h -tempered uniformly in $s \in \mathbb{R}$ and also in the L^2 sense in s .

Taking the Fourier transform of (3.8.8), we get

$$(hD_s + P - ih\nu)\Pi \hat{u}(s) = \Pi \hat{f}(s) + \mathcal{O}(h^\infty)_{L_s^2(\mathbb{R})} \quad \text{microlocally near } \widehat{W}. \quad (3.8.41)$$

We use the operators $\mathcal{X}_+, \mathcal{Z}_+, A_1$ from §3.8.3. Similarly to (3.8.33), we find

$$\begin{aligned} \text{Im} \langle \mathcal{X}_+ \Pi \hat{u}(s), \Pi \hat{f}(s) \rangle &= \frac{h}{2} \partial_s \langle \mathcal{X}_+ \Pi \hat{u}(s), \Pi \hat{u}(s) \rangle \\ &+ h \langle \mathcal{Z}_+ \Pi \hat{u}(s), \Pi \hat{u}(s) \rangle + \mathcal{O}(h^2) \|A_1 \Pi \hat{u}(s)\|_{L_x^2}^2 + \mathcal{O}(h^\infty)_{L_s^1(\mathbb{R})}. \end{aligned}$$

Integrating this over $s \in (-\infty, s_0]$, by the assumption of (3.8.39), we find

$$\begin{aligned} \langle \mathcal{X}_+ \Pi \hat{u}(s_0), \Pi \hat{u}(s_0) \rangle &+ 2 \int_{-\infty}^{s_0} \langle \mathcal{Z}_+ \Pi \hat{u}(s), \Pi \hat{u}(s) \rangle ds \\ &\leq Ch \|A_1 \Pi \hat{u}(s)\|_{L_s^2((-\infty, s_0])L_x^2}^2 + \mathcal{O}(h^\infty). \end{aligned} \quad (3.8.42)$$

Applying Lemma 3.8.7 to $Q = A_1$ and $Z = \mathcal{Z}_+, \mathcal{X}_+$, and using (3.8.34), we get

$$\|A_1 \Pi \hat{u}(s)\|_{L_x^2}^2 \leq C \langle \mathcal{Z}_+ \Pi \hat{u}(s), \Pi \hat{u}(s) \rangle + \mathcal{O}(h^\infty)_{L_s^1(\mathbb{R})}, \quad (3.8.43)$$

$$\|A_1 \Pi \hat{u}(s_0)\|_{L_x^2}^2 \leq C \langle \mathcal{X}_+ \Pi \hat{u}(s_0), \Pi \hat{u}(s_0) \rangle + \mathcal{O}(h^\infty). \quad (3.8.44)$$

Combining (3.8.42) with (3.8.43), integrated over $s \in (-\infty, s_0]$, and (3.8.44), we get the conclusion of (3.8.39). \square

3.8.5 Localization of resonant states

In this section, we study an application of the estimates of the preceding subsections to microlocal behavior of resonant states, namely elements of the kernel of $\mathcal{P}(\omega)$ for a resonance ω . Assume that we are given a sequence $h_j \rightarrow 0$, and $\omega(h) \in \mathbb{C}$, $\tilde{u}(h) \in \mathcal{H}_1$, defined for h in this sequence, such that

$$\begin{aligned} \mathcal{P}(\omega)\tilde{u} &= 0, \quad \|\tilde{u}\|_{\mathcal{H}_1} = 1; \\ \operatorname{Re} \omega &\in [\alpha_0, \alpha_1], \quad \operatorname{Im} \omega \in [-(\nu_{\min} - \varepsilon)h, C_0h]; \end{aligned} \tag{3.8.45}$$

the condition on ω is just (3.8.9). We also use the operators $\mathcal{S}(\omega)$ and P from Lemma 3.4.3 and put

$$u := \mathcal{S}(\omega)\tilde{u}, \tag{3.8.46}$$

so that

$$(P - \omega)u = \mathcal{O}(h^\infty) \quad \text{microlocally near } \mathcal{U}. \tag{3.8.47}$$

We say that the sequence $u(h_j)$ converges to some Radon measure μ on T^*X , and we call μ the semiclassical defect measure of u (see [137, Chapter 5]) if for each compactly supported $A \in \Psi^0(M)$, we have

$$\langle Au, u \rangle \rightarrow \int_{T^*M} \sigma(A) d\mu \quad \text{as } h_j \rightarrow 0. \tag{3.8.48}$$

Such μ is necessarily a nonnegative measure, see [137, Theorem 5.2].

Theorem 3.4. *Let $\tilde{u}(h)$ be a sequence of resonant states corresponding to some resonances $\omega(h)$, as in (3.8.45), and u defined in (3.8.46). Take the neighborhood \widehat{W} of $K \cap p^{-1}([\alpha_0, \alpha_1])$ defined in (3.7.1). Then:*

- (1) $\operatorname{WF}_h(\tilde{u}) \cap \mathcal{U} \subset \Gamma_+ \cap p^{-1}([\alpha_0, \alpha_1])$;
- (2) for each $A_1 \in \Psi^{\operatorname{comp}}(X)$ elliptic on $K \cap p^{-1}([\alpha_0, \alpha_1])$, there exists a constant $c > 0$ independent of h such that $\|A_1 u\|_{L^2} \geq c$;
- (3) $u = \Pi u + \mathcal{O}(h^\infty)$ and $\Theta_+ u = \mathcal{O}(h^\infty)$ microlocally near \widehat{W} , where Π is constructed in Theorem 3.3 in §3.7.1 and Θ_+ is the pseudodifferential operator from Proposition 3.7.1;
- (4) there exists a smooth family of smooth measures μ_ρ , $\rho \in K \cap p^{-1}([\alpha_0, \alpha_1])$, on the flow line segments $\pi_+^{-1}(\rho) \cap \widehat{W} \subset \Gamma_+$ of \mathcal{V}_+ , independent of the choice of u , such that if u converges to some measure μ on T^*M in the sense of (3.8.48), and $\operatorname{Re} \omega(h_j) \rightarrow \omega_\infty$, $h^{-1} \operatorname{Im} \omega(h_j) \rightarrow \nu$ as $h_j \rightarrow 0$, then $\mu|_{\widehat{W}}$ has the form

$$\mu|_{\widehat{W}} = \int_{K \cap p^{-1}(\omega_\infty)} \mu_\rho d\hat{\mu}(\rho), \tag{3.8.49}$$

for some nontrivial measure $\hat{\mu}$ on $K \cap p^{-1}(\omega_\infty)$, such that for each $b \in C^\infty(K)$,

$$\int_{K \cap p^{-1}(\omega_\infty)} H_p b - (2\nu + c_+) b d\hat{\mu} = 0, \quad (3.8.50)$$

with the function c_+ defined in Lemma 3.5.1.

Remark. The equation (3.8.50) is similar to the equation satisfied by semiclassical defect measures for eigenstates for the damped wave equation, see [137, (5.3.21)].

Proof. Part (1) follows immediately from Lemma 3.4.4, part (2) follows from Lemma 3.4.6 and implies that $\mu|_{\widehat{W}}$ is a nontrivial measure in part (4). By the discussion in §3.8.1, u satisfies (3.8.3)–(3.8.6), with $f = 0$. The first statement of part (3) then follows from Proposition 3.8.1. Indeed, we have $(1 - \Pi)u = \mathcal{O}(h^\infty)$ microlocally near the set W' introduced in (3.8.1); it remains to apply propagation of singularities (Proposition 3.3.4) to (3.8.13), using Lemma 3.4.1. The second statement of part (3) now follows from (3.8.25).

Finally, we prove part (4). First of all, $\mu|_u$ is supported on Γ_+ by part (1), and on $p^{-1}(\omega_\infty)$ by (3.8.47) and the elliptic estimate (Proposition 3.3.2; see also [137, Theorem 5.3]). Next, note that by Lemma 3.8.5 and since $u = \Pi u + \mathcal{O}(h^\infty)$ microlocally near \widehat{W} , we have for each $a \in C_0^\infty(\widehat{W})$ and the function ψ given by (3.8.26),

$$\int (e^\psi a)(e^{sH_{\varphi_+}}(\rho)) ds = 0 \quad \text{for all } \rho \in K \cap p^{-1}(\omega_\infty) \implies \int a d\mu = 0.$$

This implies (3.8.49), with

$$\int a d\mu_\rho := \int (e^\psi a)(e^{sH_{\varphi_+}}(\rho)) ds, \quad a \in C_0^\infty(\widehat{W}), \quad \rho \in K \cap p^{-1}(\omega_\infty).$$

To see (3.8.50), we note that by (3.8.47), for each $a \in C_0^\infty(\widehat{W})$ we have (see the derivation of [137, (5.3.21)])

$$\int H_p a - 2\nu a d\mu = 0. \quad (3.8.51)$$

Put $b(\rho) = \int a d\mu_\rho$ for $\rho \in K \cap p^{-1}(\omega_\infty)$. Similarly to Lemma 3.8.6 (replacing 1 by $b(\rho)$ on the right-hand side of (3.8.29)), we compute

$$\int H_p a d\mu_\rho = H_p b(\rho) - c_+(\rho)b(\rho), \quad \rho \in K \cap p^{-1}(\omega_\infty)$$

and (3.8.50) follows by (3.8.51). □

3.9 Grushin problem

In this section, we construct a well-posed Grushin problem for the scattering resolvent, representing resonances in the region (3.8.9) as zeroes of a certain determinant $F(\omega)$ defined in (3.9.25) below. Together with the trace formulas of §3.10, this makes possible the proof of the Weyl law in §3.11.

We assume that the conditions of §§3.4.1 and 3.5.1 hold, fix $\varepsilon > 0$ (to be chosen in Theorem 3.2), and use the neighborhoods $W' \subset \widehat{W}$ of $K \cap p^{-1}([\alpha_0, \alpha_1])$ defined in (3.8.1); let $\delta, \delta_1 > 0$ be the constants used to define these neighborhoods. Take compactly supported $Q_1, Q_2 \in \Psi^{\text{comp}}(X)$ such that (with U_δ defined in Lemma 3.5.1)

$$\begin{aligned} Q_1 &= 1 + \mathcal{O}(h^\infty) \quad \text{microlocally near } U_{\delta/4} \cap p^{-1}([\alpha_0 - \delta_1/6, \alpha_1 + \delta_1/6]), \\ Q_2 &= 1 + \mathcal{O}(h^\infty) \quad \text{microlocally near } U_{\delta/3} \cap p^{-1}([\alpha_0 - \delta_1/5, \alpha_1 + \delta_1/5]), \\ \text{WF}_h(Q_1) &\Subset U_{\delta/3} \cap p^{-1}([\alpha_0 - \delta_1/5, \alpha_1 + \delta_1/5]), \quad \text{WF}_h(Q_2) \Subset W'. \end{aligned} \quad (3.9.1)$$

We will impose more restrictions on Q_1 later in Lemma 3.9.2.

Using the operator $\mathcal{P}(\omega) : \mathcal{H}_1 \rightarrow \mathcal{H}_2$ from §3.4.1 and the operator $\mathcal{S}(\omega)$ constructed in Lemma 3.4.3, define the holomorphic family of operators

$$\mathcal{G}(\omega) := \begin{pmatrix} \mathcal{P}(\omega) & \mathcal{S}(\omega)Q_1\Pi Q_2 \\ Q_1\Pi Q_2\mathcal{S}(\omega) & 1 - Q_1\Pi Q_2 \end{pmatrix} : \mathcal{H}_1 \oplus L^2(X) \rightarrow \mathcal{H}_2 \oplus L^2(X).$$

Here $\Pi \in I_{\text{comp}}(\Lambda^\circ)$ is the operator constructed in Theorem 3.3 in §3.7.1; it is a microlocal idempotent commuting with the operator P from Lemma 3.4.3 microlocally near the set $\widehat{\Lambda} = \Lambda^\circ \cap (\widehat{W} \cap \widehat{W})$. Note that, since Q_1, Q_2 are microlocalized away from fiber infinity, $\mathcal{G}(\omega)$ is a compact perturbation of $\mathcal{P}(\omega) \oplus 1$, and therefore Fredholm of index zero.

In this section, we will prove

Proposition 3.9.1. *There exists a global constant⁷ N such that for ω satisfying (3.8.9),*

$$\|\mathcal{G}(\omega)^{-1}\|_{\mathcal{H}_2 \oplus L^2 \rightarrow \mathcal{H}_1 \oplus L^2} = \mathcal{O}(h^{-N}). \quad (3.9.2)$$

Moreover, if

$$\mathcal{G}(\omega)^{-1} = \begin{pmatrix} \mathcal{R}_{11}(\omega) & \mathcal{R}_{12}(\omega) \\ \mathcal{R}_{21}(\omega) & \mathcal{R}_{22}(\omega) \end{pmatrix}, \quad (3.9.3)$$

then $\mathcal{R}_{22}(\omega) = 1 - L_{22}(\omega) + \mathcal{O}(h^\infty)_{\mathcal{D}' \rightarrow C_0^\infty}$, where $L_{22}(\omega) \in I_{\text{comp}}(\Lambda^\circ)$ is microlocalized inside $\widehat{\Lambda}$ and the symbol $\sigma_\Lambda(L_{22})$ defined in (3.6.30) satisfies

$$\sigma_\Lambda(L_{22}(\omega))(\rho, \rho) = \frac{\sigma(Q_1)(\rho)^2 + (p(\rho) - \omega)\sigma(Q_1)(\rho)}{\sigma(Q_1)(\rho)^2 + (p(\rho) - \omega)(\sigma(Q_1)(\rho) - 1)}, \quad \rho \in \widehat{K}. \quad (3.9.4)$$

⁷A more careful analysis, as in §3.8, could give the optimal value of N ; we do not pursue this here since the value of N is irrelevant for our application in §3.11.

To prove (3.9.2), we consider families of distributions $u(h) \in \mathcal{H}_1$, $f(h) \in \mathcal{H}_2$, $v(h), g(h) \in L^2(X)$, bounded polynomially in h in the indicated spaces and satisfying $\mathcal{G}(u, v) = (f, g)$, namely

$$\mathcal{P}(\omega)u + \mathcal{S}(\omega)Q_1\Pi Q_2v = f, \quad (3.9.5)$$

$$Q_1\Pi Q_2\mathcal{S}(\omega)u + (1 - Q_1\Pi Q_2)v = g. \quad (3.9.6)$$

Note that by (3.4.9), (3.9.5) implies

$$(P - \omega)\mathcal{S}(\omega)u + Q_1\Pi Q_2v = \mathcal{S}'(\omega)f + \mathcal{O}(h^\infty) \quad \text{microlocally near } \mathcal{U}. \quad (3.9.7)$$

Here $\mathcal{S}'(\omega)$ is an elliptic parametrix of $\mathcal{S}(\omega)$ near \mathcal{U} constructed in Proposition 3.3.3.

To show (3.9.2), it is enough to establish the bound

$$\|u\|_{\mathcal{H}_1} + \|v\|_{L^2} \leq Ch^{-N}(\|f\|_{\mathcal{H}_2} + \|g\|_{L^2}) + \mathcal{O}(h^\infty). \quad (3.9.8)$$

We start with a technical lemma:

Lemma 3.9.2. *There exists $Q_1 \in \Psi^{\text{comp}}(X)$ satisfying (3.9.1) and such that*

$$\sigma(Q_1)^2 + (p - \omega)(\sigma(Q_1) - 1) \neq 0 \quad \text{on } K \text{ for all } \omega \in [\alpha_0, \alpha_1]. \quad (3.9.9)$$

Proof. It suffices to take Q_1 such that $\sigma(Q_1)|_K = \psi(p)$, where $\psi \in C_0^\infty(\alpha_0 - \delta_1/5, \alpha_1 + \delta_1/5)$ is equal to 1 near $[\alpha_0 - \delta_1/6, \alpha_1 + \delta_1/6]$ and

$$\psi(\lambda)^2 + (\lambda - \omega)(\psi(\lambda) - 1) \neq 0, \quad \lambda \in \mathbb{R}, \omega \in [\alpha_0, \alpha_1]. \quad (3.9.10)$$

We now show that such ψ exists. The equation (3.9.10) holds automatically for $\lambda \notin (\alpha_0 - \delta_1/5, \alpha_1 + \delta_1/5)$, as $\psi = 0$ there and the left-hand side of (3.9.10) equals $\omega - \lambda \neq 0$. This however also shows that a real-valued ψ with the desired properties does not exist. We take $\text{Re } \psi \in C_0^\infty(\alpha_0 - \delta_1/5, \alpha_1 + \delta_1/5)$ equal to 1 near $[\alpha_0 - \delta_1/6, \alpha_1 + \delta_1/6]$ and take values in $[0, 1]$ and $\text{Im } \psi \in C_0^\infty(\alpha_1 + \delta_1/6, \alpha_1 + \delta_1/5)$ a nonnegative function to be chosen later. Then the left-hand side of (3.9.10) is equal to 1 for $\lambda \in [\alpha_0 - \delta_1/6, \alpha_1 + \delta_1/6]$ and is positive for $\lambda \in [\alpha_0 - \delta_1/5, \alpha_0 - \delta_1/6]$. Next, the imaginary part of (3.9.10) is

$$\text{Im } \psi(\lambda)(2 \text{Re } \psi(\lambda) + \lambda - \omega).$$

Since $2 \text{Re } \psi(\lambda) + \lambda - \omega > 0$ for $\lambda \in [\alpha_1 + \delta_1/6, \alpha_1 + \delta_1/5]$, it remains to take $\text{Im } \psi(\lambda) > 0$ on a large compact subinterval of $(\alpha_1 + \delta_1/6, \alpha_1 + \delta_1/5)$; then ψ satisfies (3.9.10). \square

Using Lemma 3.9.2, we determine v microlocally outside of the elliptic region:

Proposition 3.9.3. *Let Q_1 be chosen in Lemma 3.9.2. Then there exist $L_{21}^e(\omega), L_{22}^e(\omega) \in I_{\text{comp}}(\Lambda^\circ)$ holomorphic in ω , microlocalized inside $\widehat{\Lambda}$, and such that for all u, v, f, g satisfying (3.9.5), (3.9.6),*

$$v = L_{21}^e f + (1 - L_{22}^e)g \quad (3.9.11)$$

microlocally outside of $\Gamma_+ \cap \widehat{W} \cap p^{-1}([\alpha_0 - \delta_1/8, \alpha_1 + \delta_1/8])$. Moreover, $\sigma_\Lambda(L_{22}^e)$ satisfies (3.9.4) for $\rho \notin p^{-1}([\alpha_0 - \delta_1/8, \alpha_1 + \delta_1/8])$.

Proof. Using Proposition 3.3.3, construct compactly supported $R^e(\omega) \in \Psi^{\text{comp}}(X)$ such that $R^e(\omega)(P - \omega) = 1 + \mathcal{O}(h^\infty)$ microlocally near $\widehat{W} \setminus p^{-1}(\alpha_0 - \delta_1/8, \alpha_1 + \delta_1/8)$. By (3.9.7), we get

$$\mathcal{S}(\omega)u = R^e(\omega)(\mathcal{S}'(\omega)f - Q_1\Pi Q_2v) + \mathcal{O}(h^\infty)$$

microlocally near $\widehat{W} \setminus p^{-1}(\alpha_0 - \delta_1/8, \alpha_1 + \delta_1/8)$. Substituting this into (3.9.6), we get

$$(1 - L')v = g - Q_1\Pi Q_2R^e(\omega)\mathcal{S}'(\omega)f + \mathcal{O}(h^\infty) \quad (3.9.12)$$

microlocally outside of $\Gamma_+ \cap \widehat{W} \cap p^{-1}([\alpha_0 - \delta_1/8, \alpha_1 + \delta_1/8])$, where $L' = Q_1\Pi Q_2(1 + R^e(\omega)Q_1\Pi Q_2) \in I_{\text{comp}}(\Lambda^\circ)$ and $\text{WF}_h(L') \subset \widehat{\Lambda}$.

Let $\sigma_\Lambda(L')$ be the symbol of L' , defined in (3.6.30). By (3.6.31)–(3.6.33), and since $\sigma_\Lambda(\Pi)|_K = 1$ near \widehat{W} (see part 1 of Proposition 3.6.9 or §3.7.1), we find for $\rho \in K \setminus p^{-1}(\alpha_0 - \delta_1/8, \alpha_1 + \delta_1/8)$,

$$\sigma_\Lambda(L')(\rho, \rho) = \sigma(Q_1)(\rho)(1 + \sigma(Q_1)(\rho)/(p(\rho) - \omega));$$

it follows from (3.9.9) that

$$\sigma_\Lambda(L')|_K \neq 1 \quad \text{outside of } p^{-1}(\alpha_0 - \delta_1/8, \alpha_1 + \delta_1/8). \quad (3.9.13)$$

By Proposition 3.6.6, there exists $L_{22}^e(\omega) \in I_{\text{comp}}(\Lambda^\circ)$, with $\text{WF}_h(L_{22}^e) \subset \widehat{\Lambda}$, such that $(1 - L_{22}^e)(1 - L') = 1 + \mathcal{O}(h^\infty)$ microlocally outside of $p^{-1}([\alpha_0 - \delta_1/8, \alpha_1 + \delta_1/8])$, and note that the symbol $\sigma_\Lambda(L_{22}^e)$ satisfies (3.9.4) for $\rho \notin p^{-1}([\alpha_0 - \delta_1/8, \alpha_1 + \delta_1/8])$ by (3.6.34). By (3.9.12), we get (3.9.11) with $L_{12}^e(\omega) = -(1 - L_{22}^e(\omega))Q_1\Pi Q_2R^e(\omega)\mathcal{S}'(\omega)$. \square

By Proposition 3.9.3, replacing v by $A_e v$, where $A_e \in \Psi^{\text{comp}}(X)$ is compactly supported, $\text{WF}_h(A_e) \subset \mathcal{U} \cap p^{-1}(\alpha_0 - \delta_1/7, \alpha_1 + \delta_1/7)$, and $A_e = 1 + \mathcal{O}(h^\infty)$ near $\widehat{W} \cap p^{-1}([\alpha_0 - \delta_1/8, \alpha_1 + \delta_1/8])$, we see that it is enough to prove (3.9.8) in the case

$$\text{WF}_h(v) \subset \mathcal{U} \cap p^{-1}([\alpha_0 - \delta_1/7, \alpha_1 + \delta_1/7]). \quad (3.9.14)$$

Using Lemma 3.4.5, consider $u' \in \mathcal{H}_1$ such that $\|u'\|_{\mathcal{H}_1} \leq Ch^{-1}\|f\|_{\mathcal{H}_2}$ and $\text{WF}_h(\mathcal{P}(\omega)u' - f) \subset \text{WF}_h(Q_1) \cap p^{-1}([\alpha_0 - \delta_1/7, \alpha_1 + \delta_1/7])$. Subtracting u' from u , we see that it suffices to prove (3.9.8) for the case

$$\text{WF}_h(f) \subset \text{WF}_h(Q_1) \cap p^{-1}([\alpha_0 - \delta_1/7, \alpha_1 + \delta_1/7]). \quad (3.9.15)$$

By (3.9.14), the wavefront set of $\mathcal{P}(\omega)u = f - \mathcal{S}(\omega)Q_1\Pi Q_2v$ satisfies (3.9.15). Arguing as in §3.8.1, and keeping in mind (3.9.7), we see that u satisfies (3.8.4)–(3.8.6); in fact, (3.8.4) can be strengthened to

$$\text{WF}_h(u) \cap \widehat{W} \subset p^{-1}([\alpha_0 - \delta_1/7, \alpha_1 + \delta_1/7]). \quad (3.9.16)$$

and (3.8.6) can be strengthened to

$$\text{WF}_h(u) \cap \Gamma_-^\circ \subset U_{\delta/3} \cap p^{-1}([\alpha_0 - \delta_1/7, \alpha_1 + \delta_1/7]). \quad (3.9.17)$$

We can now solve for v :

Proposition 3.9.4. *Assume that u, v, f, g satisfy (3.9.5), (3.9.6), (3.9.14), (3.9.15). Then*

$$v = Q_1 \Pi \mathcal{S}'(\omega) f + (1 - Q_1 (P - \omega + 1) \Pi Q_2) g + \mathcal{O}(h^\infty)_{C_0^\infty}. \quad (3.9.18)$$

Proof. Since $\Pi^2 = \Pi + \mathcal{O}(h^\infty)$ microlocally near $\widehat{W} \times \widehat{W}$ and $Q_1 = 1 + \mathcal{O}(h^\infty)$ microlocally near $K \cap p^{-1}([\alpha_0 - \delta_1/6, \alpha_1 + \delta_1/6])$, we have

$$\Pi Q_1 \Pi = \Pi + \mathcal{O}(h^\infty) \quad \text{microlocally near } (\widehat{W} \cap p^{-1}([\alpha_0 - \delta_1/6, \alpha_1 + \delta_1/6])) \times \widehat{W}. \quad (3.9.19)$$

We rewrite (3.9.6) as

$$Q_1 \Pi Q_2 (\mathcal{S}(\omega) u - g) + (1 - Q_1 \Pi Q_2) (v - g) = 0. \quad (3.9.20)$$

It follows immediately that $\text{WF}_h(v - g) \subset \text{WF}_h(Q_1)$ and thus $Q_2(v - g) = v - g + \mathcal{O}(h^\infty)_{C_0^\infty}$. Also, by (3.9.6), (3.9.14), and (3.9.16), $\text{WF}_h(g) \subset \mathcal{U} \cap p^{-1}([\alpha_0 - \delta_1/7, \alpha_1 + \delta_1/7])$. Applying Π to (3.9.20) and using (3.9.14), (3.9.16), and (3.9.19), we get $\Pi Q_2 \mathcal{S}(\omega) u - \Pi Q_2 g = \mathcal{O}(h^\infty)$ microlocally near \widehat{W} . By (3.9.17), we have $\Pi Q_2 \mathcal{S}(\omega) u = \Pi \mathcal{S}(\omega) u + \mathcal{O}(h^\infty)_{C_0^\infty}$; therefore,

$$\Pi \mathcal{S}(\omega) u = \Pi Q_2 g + \mathcal{O}(h^\infty) \quad \text{microlocally near } \widehat{W}. \quad (3.9.21)$$

Then (3.9.20) becomes

$$v = Q_1 \Pi Q_2 v + (1 - Q_1 \Pi Q_2) g + \mathcal{O}(h^\infty)_{C_0^\infty}. \quad (3.9.22)$$

Applying Π to (3.9.7), using that $[P, \Pi] = \mathcal{O}(h^\infty)$ microlocally near $\widehat{W} \times \widehat{W}$, and keeping in mind (3.9.17), we get

$$(P - \omega) \Pi \mathcal{S}(\omega) u + \Pi Q_2 v = \Pi \mathcal{S}'(\omega) f + \mathcal{O}(h^\infty) \quad \text{microlocally near } \widehat{W}. \quad (3.9.23)$$

Together, (3.9.21) and (3.9.23) give

$$\Pi Q_2 v = \Pi \mathcal{S}'(\omega) f - (P - \omega) \Pi Q_2 g + \mathcal{O}(h^\infty) \quad \text{microlocally near } \widehat{W}.$$

By (3.9.22), we now get (3.9.18). \square

By Proposition 3.9.4, we see that

$$\|v\|_{L^2} \leq Ch^{-N} (\|f\|_{\mathcal{H}_2} + \|g\|_{L^2}) + \mathcal{O}(h^\infty). \quad (3.9.24)$$

By Proposition 3.8.1 (using (3.9.7) instead of (3.8.3)), we get for some $A_1 \in \Psi^{\text{comp}}(X)$ elliptic near W' ,

$$\|A_1(1 - \Pi) \mathcal{S}(\omega) u\|_{L^2} \leq Ch^{-N} (\|f\|_{\mathcal{H}_2} + \|g\|_{L^2}) + \mathcal{O}(h^\infty).$$

Combining this with (3.9.21), we estimate $\|A_1 u\|_{L^2}$ by the right-hand side of (3.9.24). Applying Lemma 3.4.6 to (3.9.5), we can estimate $\|u\|_{\mathcal{H}_1}$ by the same quantity, completing the proof of (3.9.8).

It remains to describe the operator \mathcal{R}_{22} from (3.9.3). We assume that u, v, f, g satisfy (3.9.5), (3.9.6) and $f = 0$; then $\mathcal{R}_{22}g = v$. By Proposition 3.9.3, $v = (1 - L_{22}^e)g + \mathcal{O}(h^\infty)$ microlocally outside of $\widehat{W} \cap p^{-1}([\alpha_0 - \delta_1/8, \alpha_1 + \delta_1/8])$; it then suffices to describe v microlocally near $\widehat{W} \cap p^{-1}([\alpha_0 - \delta_1/8, \alpha_1 + \delta_1/8])$. Let A_e be the operator introduced before (3.9.14) and $R^e(\omega)$ be an elliptic parametrix for $P - \omega$ constructed in the proof of Proposition 3.9.3. Replacing (u, v) by $(u + \mathcal{S}'(\omega)R^e(\omega)Q_1\Pi Q_2(1 - A_e)v, A_e v)$, we may assume that (3.9.14) and (3.9.15) hold, and in fact the resulting f is $\mathcal{O}(h^\infty)_{C^\infty}$ and the resulting g coincides with the original g microlocally near $\widehat{W} \cap p^{-1}([\alpha_0 - \delta_1/8, \alpha_1 + \delta_1/8])$. By Proposition 3.9.4, we now get for the original v and g ,

$$v = (1 - Q_1(P - \omega + 1)\Pi Q_2)g + \mathcal{O}(h^\infty) \quad \text{microlocally near } \widehat{W} \cap p^{-1}([\alpha_0 - \delta_1/8, \alpha_1 + \delta_1/8]).$$

Note that $Q_1(P - \omega + 1)\Pi Q_2 \in I_{\text{comp}}(\Lambda^\circ)$ and its principal symbol satisfies (3.9.4) in $p^{-1}([\alpha_0 - \delta_1/8, \alpha_1 + \delta_1/8])$, since $\sigma(Q_1)|_K = 1$ in that region. This finishes the proof of Proposition 3.9.1.

By Proposition 3.9.1, $\mathcal{R}_{22}(\omega) - 1$ is a compactly supported operator mapping $H_h^{-N} \rightarrow H_h^N$ for all N , therefore it is trace class. We can then define the determinant (see for instance [123, (A.6.38)])

$$F(\omega) := \det \mathcal{R}_{22}(\omega), \tag{3.9.25}$$

which is holomorphic in the region (3.8.9) and $F(\omega) = 0$ if and only if $\mathcal{R}_{22}(\omega)$ is not invertible (see [123, Proposition A.6.16]). The key properties of F needed in §3.11 are established in

Proposition 3.9.5. *1. Resonances in the region (3.8.9) coincide (with the multiplicities defined in (3.4.3)) with zeroes of $F(\omega)$.*

2. For some constants C and N , we have $|F(\omega)| \leq e^{Ch^{-N}}$ for ω in (3.8.9), and $|F(\omega)| \geq e^{-Ch^{-N}}$ for ω in the resonance free region (3.1.5).

3. For ω in the resonance free region (3.1.5), we have

$$\frac{\partial_\omega F(\omega)}{F(\omega)} = -\text{Tr}((1 - Q_1\Pi Q_2 - Q_1\Pi \mathcal{S}(\omega)\mathcal{R}(\omega)\mathcal{S}(\omega)Q_1\Pi Q_2)\partial_\omega L_{22}(\omega)) + \mathcal{O}(h^\infty).$$

Here $L_{22}(\omega)$ is defined in Proposition 3.9.1.

Proof. 1. By Schur's complement formula [137, (D.1.1)], and since $\mathcal{G}(\omega)$ is invertible by Proposition 3.9.1, we know that $\mathcal{P}(\omega)$ is invertible if and only if $\mathcal{R}_{22}(\omega)$ is, and in fact

$$\mathcal{P}(\omega)^{-1} = \mathcal{R}_{11}(\omega) - \mathcal{R}_{12}(\omega)\mathcal{R}_{22}(\omega)^{-1}\mathcal{R}_{21}(\omega). \tag{3.9.26}$$

To see that the multiplicity of a resonance ω_0 defined by (3.4.3) coincides with the multiplicity of ω_0 as a zero of the function $F(\omega)$ (and in particular, to demonstrate that the multiplicity defined by (3.4.3) is a positive integer), it is enough to show that

$$\frac{1}{2\pi i} \text{Tr} \oint_{\omega_0} \mathcal{P}(\omega)^{-1} \partial_\omega \mathcal{P}(\omega) d\omega = \frac{1}{2\pi i} \text{Tr} \oint_{\omega_0} \mathcal{R}_{22}(\omega)^{-1} \partial_\omega \mathcal{R}_{22}(\omega) d\omega; \tag{3.9.27}$$

indeed, since $\partial_\omega \mathcal{R}_{22}(\omega)$ is trace class, we can put the trace inside the integral on the right-hand side of (3.9.27), yielding $\partial_\omega F(\omega)/F(\omega)$; therefore, the right-hand side gives the multiplicity of ω_0 as a zero of $F(\omega)$ by the argument principle.

Since $\partial_\omega(\mathcal{G}(\omega)^{-1}) = -\mathcal{G}(\omega)^{-1}(\partial_\omega \mathcal{G}(\omega))\mathcal{G}(\omega)^{-1}$, we have

$$\partial_\omega \mathcal{R}_{22}(\omega) = -\mathcal{R}_{21}(\omega)(\partial_\omega \mathcal{P}(\omega))\mathcal{R}_{12}(\omega) + \mathcal{A}(\omega)\mathcal{R}_{22}(\omega) + \mathcal{R}_{22}(\omega)\mathcal{B}(\omega),$$

where $\mathcal{A}(\omega), \mathcal{B}(\omega) : L^2(X) \rightarrow L^2(X)$ are bounded operators holomorphic at ω_0 . By (3.9.26), (3.9.27) follows from the two identities

$$\begin{aligned} \operatorname{Tr} \oint_{\omega_0} \mathcal{R}_{12}(\omega)\mathcal{R}_{22}(\omega)^{-1}\mathcal{R}_{21}(\omega)\partial_\omega \mathcal{P}(\omega) d\omega &= \operatorname{Tr} \oint_{\omega_0} \mathcal{R}_{22}(\omega)^{-1}\mathcal{R}_{21}(\omega)(\partial_\omega \mathcal{P}(\omega))\mathcal{R}_{12}(\omega) d\omega, \\ \operatorname{Tr} \oint_{\omega_0} \mathcal{R}_{22}(\omega)^{-1}(\mathcal{A}(\omega)\mathcal{R}_{22}(\omega) + \mathcal{R}_{22}(\omega)\mathcal{B}(\omega)) d\omega &= 0. \end{aligned}$$

Both of them follow from the cyclicity of the trace, replacing $\mathcal{R}_{22}(\omega)^{-1}$ by its finite-dimensional principal part at ω_0 and putting the trace inside the integral.

2. By Proposition 3.9.1, the trace class norm $\|\mathcal{R}_{22}(\omega) - 1\|_{\operatorname{Tr}}$ is bounded polynomially in h . Using the bound $|\det(1 + T)| \leq e^{\|T\|_{\operatorname{Tr}}}$ (see for example [123, (A.6.44)]), we get $|F(\omega)| \leq e^{Ch^{-N}}$. By Theorem 3.1, we have $\|\mathcal{R}(\omega)\|_{\mathcal{H}_2 \rightarrow \mathcal{H}_1} \leq Ch^{-2}$ when ω satisfies (3.1.5). Using Schur's complement formula again, we get

$$\mathcal{R}_{22}(\omega)^{-1} = 1 - Q_1 \Pi Q_2 - Q_1 \Pi Q_2 \mathcal{S}(\omega) \mathcal{R}(\omega) \mathcal{S}(\omega) Q_1 \Pi Q_2. \quad (3.9.28)$$

Then $\|\mathcal{R}_{22}(\omega)^{-1} - 1\|_{\operatorname{Tr}} \leq Ch^{-N}$ and thus $|F(\omega)|^{-1} = |\det(\mathcal{R}_{22}(\omega)^{-1})| \leq e^{Ch^{-N}}$.

3. By Proposition 3.9.1, we have $\partial_\omega \mathcal{R}_{22}(\omega) = -\partial_\omega L_{22}(\omega) + \mathcal{O}(h^\infty)_{\mathcal{D}' \rightarrow \mathcal{C}_0^\infty}$, thus

$$\frac{\partial_\omega F(\omega)}{F(\omega)} = -\operatorname{Tr}(\mathcal{R}_{22}(\omega)^{-1} \partial_\omega L_{22}(\omega)) + \mathcal{O}(h^\infty).$$

By (3.9.28), it then suffices to prove that

$$\operatorname{Tr}(Q_1 \Pi (1 - Q_2) \mathcal{S}(\omega) \mathcal{R}(\omega) \mathcal{S}(\omega) Q_1 \Pi Q_2 \partial_\omega L_{22}(\omega)) = \mathcal{O}(h^\infty).$$

For that, it suffices to show that the intersection of the wavefront set of the operator on the left-hand side with the diagonal in T^*X is empty. We assume the contrary, then there exists $\rho \in T^*X$ such that

$$(\rho, \rho) \in \operatorname{WF}_h(Q_1 \Pi (1 - Q_2) \mathcal{S}(\omega) \mathcal{R}(\omega) \mathcal{S}(\omega) Q_1 \Pi Q_2 \partial_\omega L_{22}(\omega)).$$

Since both Π and $\partial_\omega L_{22}$ are microlocalized inside $\Lambda^\circ \subset \Gamma_-^\circ \cap \Gamma_+^\circ$, we see that $\rho \in K^\circ = \Gamma_+^\circ \cap \Gamma_-^\circ$. There exists $\rho' \in T^*X$ such that

$$(\rho, \rho') \in \operatorname{WF}_h(\mathcal{S}(\omega) \mathcal{R}(\omega) \mathcal{S}(\omega) Q_1 \Pi Q_2 \partial_\omega L_{22}(\omega)), \quad (\rho', \rho) \in \operatorname{WF}_h(Q_1 \Pi (1 - Q_2)).$$

For any h -tempered $f \in L^2(X)$, we have $\operatorname{WF}_h(\mathcal{S}(\omega) Q_1 \Pi Q_2 \partial_\omega L_{22}(\omega) f) \subset \Gamma_+^\circ \cap \widehat{W}$, therefore by Lemma 3.4.4 we have $\operatorname{WF}_h(\mathcal{R}(\omega) \mathcal{S}(\omega) Q_1 \Pi Q_2 \partial_\omega L_{22}(\omega) f) \cap \mathcal{U} \subset \Gamma_+$. It follows that $\rho' \in \Gamma_+$. Since $(\rho', \rho) \in \operatorname{WF}_h(Q_1 \Pi (1 - Q_2))$, we see that $\rho' = \rho \in K^\circ$. However, then $\rho \in \operatorname{WF}_h(Q_1) \cap \operatorname{WF}_h(1 - Q_2)$, which is impossible since $Q_2 = 1 + \mathcal{O}(h^\infty)$ microlocally near $\operatorname{WF}_h(Q_1)$. \square

3.10 Trace formula

In this section, we establish an asymptotic expansion for contour integrals of the logarithmic derivative of the determinant $F(\omega)$ of the effective Hamiltonian of the Grushin problem of §3.9, defined in (3.9.25). By Proposition 3.9.5, this reduces to computing contour integrals of operators of the form $\Pi\mathcal{R}(\omega)$, where Π is the projector constructed in Theorem 3.3 in §3.7.1. This in turn is done by approximating $\mathcal{R}(\omega)$ microlocally on the image of Π by pseudodifferential operators, using Schrödinger propagators and microlocalization in the spectral parameter established in §3.8.4.

We operate under the pinching condition (3.1.7) of Theorem 3.2, namely $\nu_{\max} < 2\nu_{\min}$, and choose $\varepsilon > 0$ such that $\nu_{\max} + \varepsilon < 2(\nu_{\min} - \varepsilon)$. Take $\chi \in C_0^\infty(\alpha_0, \alpha_1)$ with α_0, α_1 from (3.4.1). Consider an almost analytic extension $\tilde{\chi}(\omega)$ of χ , that is $\tilde{\chi} \in C^\infty(\mathbb{C})$ such that $\tilde{\chi}|_{\mathbb{R}} = \chi$ and $\partial_{\bar{\omega}}\tilde{\chi}(\omega) = \mathcal{O}(|\operatorname{Im}\omega|^\infty)$. We may take $\tilde{\chi}$ such that $\operatorname{supp}(\tilde{\chi}) \subset \{\operatorname{Re}\omega \in (\alpha_0, \alpha_1)\}$.

The main result of this section is

Proposition 3.10.1. *Take*

$$\nu_- \in \left[-(\nu_{\min} - \varepsilon), -\frac{\nu_{\max} + \varepsilon}{2} \right], \quad \nu_+ \in \left[-\frac{\nu_{\min} - \varepsilon}{2}, C_0 \right]. \quad (3.10.1)$$

Let $F(\omega)$ be defined in (3.9.25) and put

$$\mathcal{I}_\chi^\pm := (2\pi h)^{n-1} \int_{\operatorname{Im}\omega = h\nu_\pm} \tilde{\chi}(\omega) \frac{\partial_\omega F(\omega)}{F(\omega)} d\omega. \quad (3.10.2)$$

Then, with $d\operatorname{Vol}_\sigma = \sigma_S^{n-1}/(n-1)!$ the symplectic volume form,

$$\mathcal{I}_\chi^- - \mathcal{I}_\chi^+ = 2\pi i \int_K \chi(p) d\operatorname{Vol}_\sigma + \mathcal{O}(h). \quad (3.10.3)$$

Remark. More precise trace formulas are possible; in particular, one can get a full asymptotic expansion in h of each of \mathcal{I}_χ^\pm . For simplicity, we prove here a less general version which suffices for the analysis of §3.11.

The key feature of the expansions for the integrals (3.10.2), which produces a nontrivial asymptotics for resonances in Theorem 3.2, is that the principal part of \mathcal{I}_χ^\pm depends on the sign of \pm . The reason for this dependence is the difference of directions for propagation in the resolvent approximation \mathcal{R}_ψ^\pm of Proposition 3.10.2 for the two cases; this in turn is explained by the difference between (3.8.39) and (3.8.40), which is due to the difference of the signs of the ‘commutator’ \mathcal{Z}_+ between (3.8.34) and (3.8.35).

We start the proof by using Proposition 3.8.8 to replace $\mathcal{R}(\omega)$ in the formula for $\partial_\omega F(\omega)/F(\omega)$ from Proposition 3.9.5 by an operator $\mathcal{R}_\psi^\pm(\omega)$ obtained by integrating the Schrödinger propagator $e^{-it(P-\omega)/h}$ over a bounded range of times t .

Proposition 3.10.2. Fix $\psi \in C_0^\infty(\mathbb{R})$ such that $\psi = 1$ near zero. For $\omega \in \mathbb{C}$, define the operators $\mathcal{R}_\psi^\pm(\omega) : L^2(X) \rightarrow L^2(X)$ by

$$\mathcal{R}_\psi^+(\omega) := \frac{i}{h} \int_{-\infty}^0 e^{is(P-\omega)/h} \psi(s) ds; \quad (3.10.4)$$

$$\mathcal{R}_\psi^-(\omega) := -\frac{i}{h} \int_0^\infty e^{is(P-\omega)/h} \psi(s) ds; \quad (3.10.5)$$

Then, if $\text{supp } \psi$ is contained in a small enough neighborhood of zero,

$$\begin{aligned} \mathcal{I}_\chi^\pm &= -(2\pi h)^{n-1} \text{Tr} \int_{\text{Im } \omega = h\nu_\pm} \tilde{\chi}(\omega) (1 - Q_1 \Pi Q_2 \\ &\quad - Q_1 \mathcal{R}_\psi^\pm(\omega) \Pi Q_1 \Pi Q_2) \partial_\omega L_{22}(\omega) d\omega + \mathcal{O}(h^\infty). \end{aligned} \quad (3.10.6)$$

Proof. We concentrate on the case of \mathcal{I}_χ^+ , the case of \mathcal{I}_χ^- is handled similarly, using (3.8.40) in place of (3.8.39). We denote $\omega = \alpha + ih\nu_+$, where $\alpha \in (\alpha_0, \alpha_1)$. By part 3 of Proposition 3.9.5, it suffices to prove the trace norm bound

$$\left\| \int_{\text{Im } \omega = h\nu_+} \tilde{\chi}(\omega) Q_1 (\Pi \mathcal{S}(\omega) \mathcal{R}(\omega) \mathcal{S}(\omega) - \mathcal{R}_\psi^+(\omega) \Pi) Q_1 \Pi Q_2 \partial_\omega L_{22}(\omega) d\omega \right\|_{\text{Tr}} = \mathcal{O}(h^\infty).$$

Since the operator on the left-hand side is compactly supported and microlocalized away from the fiber infinity, it is enough to prove an estimate of the $L^2 \rightarrow L^2$ operator norm instead of the trace class norm. Take arbitrary h -independent family $\tilde{f} = \tilde{f}(h) \in L^2(X)$ with $\|\tilde{f}\|_{L^2} \leq 1$ and put

$$f(\alpha) := \tilde{\chi}(\omega) Q_1 \Pi Q_2 \partial_\omega L_{22}(\omega) \tilde{f}, \quad u(\alpha) := \mathcal{S}(\omega) \mathcal{R}(\omega) \mathcal{S}(\omega) f(\alpha).$$

Then $f(x, \alpha)$ is compactly supported in both $x \in X$ and $\alpha \in (\alpha_0, \alpha_1)$, $\|f\|_{L^\infty L_x^2}$ is polynomially bounded in h , and $\text{WF}_h(f(\alpha)) \subset \Gamma_+ \cap W'$. Since $\mathcal{R}(\omega)_{\mathcal{H}_2 \rightarrow \mathcal{H}_1} = \mathcal{O}(h^{-2})$ by Theorem 3.1, we see that $u(\alpha) \in \mathcal{H}_2$ is compactly supported in $\alpha \in (\alpha_0, \alpha_1)$ and the norm $\|u\|_{L^\infty L_x^2}$ is bounded polynomially in h . Using Lemma 3.4.4 similarly to §3.8.1, we see that u, f satisfy (3.8.3)–(3.8.6), uniformly in α .

It now suffices to prove that for each choice of \tilde{f} , independent of α , we have

$$\int_{\alpha_0}^{\alpha_1} Q_1 (\Pi u(\alpha) - R_\psi^+(\omega) \Pi f(\alpha)) d\alpha = \mathcal{O}(h^\infty)_{L^2}. \quad (3.10.7)$$

Define the semiclassical Fourier transforms $\hat{u}(s), \hat{f}(s)$ by (3.8.38). Then (3.10.7) becomes

$$Q_1 \left(\Pi \hat{u}(0) - \frac{i}{h} \int_{-\infty}^0 e^{is(P-ih\nu_+)/h} \psi(s) \Pi \hat{f}(s) ds \right) = \mathcal{O}(h^\infty)_{L^2}. \quad (3.10.8)$$

By (3.8.41) and Proposition 3.3.1, we find microlocally near W' ,

$$\Pi \hat{u}(0) = \frac{i}{h} \int_{-\infty}^0 e^{is(P-ih\nu_+)/h} (\psi(s) \Pi \hat{f}(s) - ih\psi'(s) \Pi \hat{u}(s)) ds + \mathcal{O}(h^\infty). \quad (3.10.9)$$

Take $\tilde{\varepsilon} > 0$ such that $\psi = 1$ near $[-\tilde{\varepsilon}, \tilde{\varepsilon}]$, so that $\psi'(s)$ is compactly supported in $\{|s| > \tilde{\varepsilon}\}$. Since $\chi(\omega)$ and $\partial_\omega L_{22}(\omega)$ depend smoothly on α , we see that $\|\partial_\alpha^j f(\alpha)\|_{L_\alpha^\infty L_x^2} = \mathcal{O}(h^{-1/2})$ for all j . By repeated integration by parts, we get

$$\|\hat{f}(s)\|_{L_s^2((-\infty, -\tilde{\varepsilon})L_x^2} = \mathcal{O}(h^\infty).$$

Then by (3.8.39), $\Pi\hat{u}(s) = \mathcal{O}(h^\infty)$ microlocally near W' locally uniformly in $s \in (-\infty, -\tilde{\varepsilon}]$, and thus $Q_1 e^{is(P-ih\nu_+)/h} \Pi\hat{u}(s) = \mathcal{O}(h^\infty)_{L^2}$ uniformly in $s \in (-\infty, 0] \cap \text{supp } \psi'$. By (3.10.9), we now get (3.10.8). \square

Now, note that, since the expression under the integral in (3.10.6) is almost analytic in ω , we can replace the integral over $\text{Im } \omega = h\nu_\pm$ by the integral over the real line, with an $\mathcal{O}(h^\infty)$ error. Then

$$\begin{aligned} \mathcal{I}_\chi^- - \mathcal{I}_\chi^+ &= (2\pi h)^{n-1} \text{Tr } \mathcal{A}_\chi + \mathcal{O}(h^\infty), \\ \mathcal{A}_\chi &:= \int_{\mathbb{R}} \chi(\alpha) \partial_\alpha L_{22}(\alpha) Q_1 (\mathcal{R}_\psi^-(\alpha) - \mathcal{R}_\psi^+(\alpha)) \Pi Q_1 \Pi Q_2 d\alpha. \end{aligned}$$

Proposition 3.10.1 now follows from Proposition 3.6.7, the fact that $\text{WF}_h(\mathcal{A}_\chi) \subset \widehat{W} \times \widehat{W}$, and the following

Proposition 3.10.3. *The operator \mathcal{A}_χ lies in $I_{\text{comp}}(\Lambda^\circ)$ and its principal symbol, as defined by (3.6.30), satisfies $\sigma_\Lambda(\mathcal{A}_\chi) \circ j_K = 2\pi i \chi(p)$, with $j_K : K^\circ \rightarrow \Lambda^\circ$ defined in (3.6.2).*

Proof. Given the multiplication formula (3.6.31), the fact that $\sigma(Q_1) = \sigma(Q_2) = 1$ and $\sigma_\Lambda(\Pi) \circ j_K = 1$ on $K \cap p^{-1}([\alpha_0, \alpha_1])$ and $\text{supp } \chi \subset (\alpha_0, \alpha_1)$, it is enough to prove the proposition with \mathcal{A}_χ replaced by

$$\mathcal{A}'_\chi := -\frac{i}{h} \int_{\mathbb{R}^2} e^{-is\alpha/h} \chi(\alpha) \partial_\alpha L_{22}(\alpha) Q_1 e^{isP/h} \psi(s) ds d\alpha.$$

Denote $\mathcal{L}(\alpha) = \chi(\alpha) \partial_\alpha L_{22}(\alpha) Q_1$; it is an operator in $I_{\text{comp}}(\Lambda^\circ)$. By applying a microlocal partition of unity to $\mathcal{L}(\alpha)$, we may reduce to the case when both $\mathcal{L}(\alpha)$ and $e^{isP/h}$ have local parametrizations (see (3.3.3) for the first one and for example [137, Theorem 10.4] for the second one)

$$\begin{aligned} \mathcal{L}(\alpha)u(x) &= (2\pi h)^{-(N+n)/2} \int_{\mathbb{R}^{N+n}} e^{\frac{i}{h}\Phi(x,y,\theta)} a(x,y,\theta,\alpha;h)u(y) dy d\theta, \\ e^{isP/h}u(y) &= (2\pi h)^{-n} \int_{\mathbb{R}^{2n}} e^{\frac{i}{h}(S(y,\zeta,s)-z\cdot\zeta)} b(y,\zeta,s;h)u(z) dz d\zeta. \end{aligned}$$

Here $S(y,\zeta,s) = y \cdot \zeta + sp(y,\zeta) + \mathcal{O}(s^2)$ and $b(y,\zeta,0;0) = 1$. Then \mathcal{A}'_χ takes the form

$$\begin{aligned} \mathcal{A}'_\chi u(x) &= -ih^{-1} (2\pi h)^{-(N+3n)/2} \int_{\mathbb{R}^{N+3n}} e^{\frac{i}{h}(\Phi(x,y,\theta)+S(y,\zeta,s)-z\cdot\zeta-s\alpha)} \\ &\quad a(x,y,\theta,\alpha;h)b(y,\zeta,s;h)\psi(s)u(z) dy d\theta dz d\zeta ds d\alpha. \end{aligned}$$

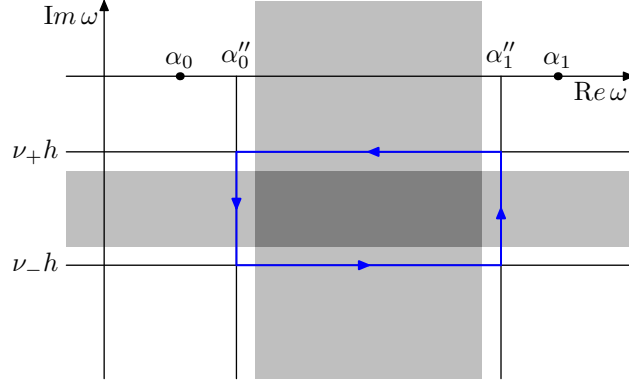

Figure 3.6: The contour $\partial\Omega(h)$ (in blue). The horizontal shaded region is $\{\text{Im } \omega \in (-(\nu_{\max} + \varepsilon)h/2, -(\nu_{\min} - \varepsilon)h/2)\}$, where Theorem 3.1 does not provide polynomial resolvent bounds; the vertical shaded region is the support of $\tilde{\chi}$.

We now apply the method of stationary phase in the y, ζ, s, α variables. The stationary points are given by $s = 0$, $\alpha = p(z, \zeta)$, $y = z$, $\zeta = -\partial_z \Phi(x, z, \theta)$. We get

$$\mathcal{A}'_{\chi} u(x) = -2\pi i (2\pi h)^{-(N+n)/2} \int_{\mathbb{R}^{N+n}} e^{\frac{i}{h} \Phi(x, z, \theta)} c(x, z, \theta; h) u(z) d\theta dz,$$

where c is a classical symbol and $c(x, z, \theta; 0) = a(x, z, \theta, p(z, -\partial_z \Phi(x, z, \zeta)); 0)$. It follows that $\mathcal{A}'_{\chi} \in I_{\text{comp}}(\Lambda^{\circ})$ and $\sigma_{\Lambda}(\mathcal{A}'_{\chi})(\rho_-, \rho_+) = -2\pi i \sigma_{\Lambda}(\mathcal{L}(p(\rho_-)))(\rho_-, \rho_+)$. By (3.9.4), $\sigma_{\Lambda}(L_{22}(\alpha))(\rho, \rho) = p(\rho) - \alpha + 1$ when $\rho \in K \cap p^{-1}([\alpha_0, \alpha_1])$, and thus $\sigma_{\Lambda}(\partial_{\alpha} L_{22}(\alpha))(\rho, \rho) = -1$. Therefore, we find $\sigma_{\Lambda}(\mathcal{A}'_{\chi})(\rho, \rho) = 2\pi i \chi(p(\rho))$ for $\rho \in K$. \square

3.11 Weyl law for resonances

In this section, we prove Theorem 3.2, using the Grushin problem from §3.9, the trace formula of §3.10, and several tools from complex analysis. The argument below is quite standard, see for instance [84, 106, 109], and is simplified by the fact that we do not aim for the optimal $\mathcal{O}(h)$ remainder in the Weyl law, instead carrying out the argument in a rectangle of width ~ 1 and height $\sim h$. For more sophisticated techniques needed to obtain the optimal remainder, see [107].

First of all, by Proposition 3.9.5, resonances in the region of interest are (with multiplicities) the zeroes of the holomorphic function $F(\omega)$ defined in (3.9.25). Take $\alpha''_0 \in (\alpha_0, \alpha'_0)$, $\alpha''_1 \in (\alpha'_1, \alpha_1)$. Fix ν_{\pm} satisfying (3.10.1) and let $\{\omega_j\}_{j=1}^{M(h)}$ denote the set of zeroes (counted with multiplicities) of $F(\omega)$ in the region (see Figure 3.6)

$$\Omega(h) := \{\text{Re } \omega \in [\alpha''_0, \alpha''_1], \text{Im } \omega \in [\nu_- h, \nu_+ h]\}$$

By part 2 of Proposition 3.9.5 and Jensen's inequality, see for example [36, §2], we have the polynomial bound, for some N, C ,

$$M(h) \leq Ch^{-N}. \quad (3.11.1)$$

By a standard argument approximating the indicator function of $[\alpha'_0, \alpha'_1]$ by smooth functions from above and below, it is enough to prove that for each $\chi \in C_0^\infty(\alpha_0, \alpha_1)$,

$$(2\pi h)^{n-1} \sum_{j=1}^{M(h)} \chi(\operatorname{Re} \omega_j) = \int_K \chi(p) d\operatorname{Vol}_\sigma + \mathcal{O}(h). \quad (3.11.2)$$

Let $\tilde{\chi}(\omega)$ be an almost analytic continuation of χ , as discussed in the beginning of §3.10. We may assume that $\operatorname{supp} \tilde{\chi} \subset \{\operatorname{Re} \omega \in (\alpha''_0, \alpha''_1)\}$.

By Proposition 3.10.1, we have (with the integral over the vertical parts of $\partial\Omega(h)$ vanishing since $\tilde{\chi} = 0$ there)

$$\frac{(2\pi h)^{n-1}}{2\pi i} \oint_{\partial\Omega(h)} \tilde{\chi}(\omega) \frac{\partial_\omega F(\omega)}{F(\omega)} d\omega = \int_K \chi(p) d\operatorname{Vol}_\sigma + \mathcal{O}(h). \quad (3.11.3)$$

By Lemma α in [124, §3.9] and the exponential estimates of part 2 of Proposition 3.9.5 (splitting the region $\Omega(h)$ into boxes of size h and applying Lemma α to each of these boxes, transformed into the unit disk by the Riemann mapping theorem), we have for some fixed N ,

$$\frac{\partial_\omega F(\omega)}{F(\omega)} = \sum_{j=1}^{M(h)} \frac{1}{\omega - \omega_j} + G(\omega); \quad G(\omega) = \mathcal{O}(h^{-N}), \quad \omega \in \Omega(h) \cap \operatorname{supp} \tilde{\chi}.$$

Applying Stokes theorem to (3.11.3) (over the contour comprised of $\partial\Omega(h)$ minus the sum of circles of small radius r centered at each ω_j , and letting $r \rightarrow 0$) we get

$$(2\pi h)^{n-1} \sum_{j=1}^{M(h)} \tilde{\chi}(\omega_j) = \int_K \chi(p) d\operatorname{Vol}_\sigma - \frac{(2\pi h)^{n-1}}{2\pi i} \int_{\Omega(h)} \frac{\partial_\omega F(\omega)}{F(\omega)} \partial_{\bar{\omega}} \tilde{\chi}(\omega) d\bar{\omega} \wedge d\omega + \mathcal{O}(h).$$

Since $\tilde{\chi}$ is almost analytic and $\Omega(h)$ lies $\mathcal{O}(h)$ close to the real line, we have $\partial_{\bar{\omega}} \tilde{\chi}(\omega) = \mathcal{O}(h^\infty)$ for $\omega \in \Omega(h)$. Therefore, the second integral on the right-hand side is $\mathcal{O}(h^\infty)$ and we get

$$(2\pi h)^{n-1} \sum_{j=1}^{M(h)} \tilde{\chi}(\omega_j) = \int_K \chi(p) d\operatorname{Vol}_\sigma + \mathcal{O}(h).$$

Since $\tilde{\chi}(\omega) = \chi(\operatorname{Re} \omega) + \mathcal{O}(h)$ for $\omega \in \Omega(h)$, we get

$$(2\pi h)^{n-1} \sum_{j=1}^{M(h)} \chi(\operatorname{Re} \omega_j) = \int_K \chi(p) d\operatorname{Vol}_\sigma + \mathcal{O}(h(1 + h^{n-1}M(h))). \quad (3.11.4)$$

Since one can take χ to be any compactly supported function on (α_0, α_1) , and $M(h) = \mathcal{O}(h^{-N})$ for some fixed N and any choice of (α''_0, α''_1) , by induction we see from (3.11.4) that $M(h) = \mathcal{O}(h^{1-n})$. Given this bound, (3.11.4) implies (3.11.2), which finishes the proof.

3.A Example of a manifold with r -normally hyperbolic trapping

In this appendix, we provide a simple example of an even asymptotically hyperbolic manifold (as defined in §3.4.4) whose geodesic flow satisfies the dynamical assumptions of §3.5.1 and the pinching condition (3.1.7), therefore our Theorems 3.1–3.4 apply. This example is a higher dimensional generalization of the hyperbolic cylinder, considered for instance in [36, Appendix B].

The resonances for the provided example can be described explicitly via the eigenvalues of the Laplacian on the underlying compact manifold N , using separation of variables. However, our results apply to small perturbations of the metric (see §3.5.2), as well as to subprincipal perturbations in the considered operator, when separation of variables no longer takes place.

Let (N, \tilde{g}) be a compact $n - 1$ dimensional Riemannian manifold (at the end of this appendix, we will impose further conditions on \tilde{g}). We consider the manifold $M = \mathbb{R}_r \times N_\theta$ with the metric

$$g = dr^2 + \cosh^2 r \tilde{g}(\theta, d\theta).$$

Then M has two infinite ends $\{r = \pm\infty\}$; near each of these ends, one can represent it as an even asymptotically hyperbolic manifold by taking the boundary defining function $\tilde{x} = e^{\mp r}$:

$$g = \frac{d\tilde{x}^2}{\tilde{x}^2} + \frac{(1 + \tilde{x}^2)^2}{4\tilde{x}^2} \tilde{g}(\theta, d\theta).$$

The resonances for the Laplace–Beltrami operator on M therefore fit into the framework of §3.4.1, as demonstrated in §3.4.4. The associated flow e^{tH_p} is the geodesic flow on the unit cotangent S^*M , extended to a homogeneous flow of degree zero on the complement of the zero section in T^*M .

We now verify the assumptions of §3.5.1. If ξ_r, ξ_θ are the momenta dual to r, θ , then

$$p^2 = \xi_r^2 + \cosh^{-2} r \tilde{g}^{-1}(\theta, \xi_\theta),$$

where \tilde{g}^{-1} is the dual metric to \tilde{g} , defined on the fibers of T^*N . We then have

$$H_p r = \frac{\xi_r}{p}, \quad H_p \xi_r = \frac{p^2 - \xi_r^2}{p} \tanh r.$$

The trapped set K and the incoming/outgoing tails Γ_\pm are given by

$$\Gamma_\pm = \{\xi_r = \pm p \tanh r\}, \quad K = \{r = 0, \xi_r = 0\},$$

or strictly speaking, by the intersections of the sets above with the set \bar{U} from (3.4.21).

Consider the following defining functions of Γ_\pm :

$$\varphi_\pm = \xi_r \mp p \tanh r,$$

then $\{\varphi_+, \varphi_-\}|_K = 2p$ and thus assumptions (1) and (2) of §3.5.1 are satisfied. Next,

$$H_p \varphi_{\pm} = \mp c_{\pm} \varphi_{\pm}, \quad c_{\pm} = 1 \pm \frac{\xi_r}{p} \tanh r.$$

In particular, $c_{\pm}|_K = 1$ and, arguing as in the proof of Lemma 3.5.1, we get

$$\nu_{\min} = \nu_{\max} = 1.$$

In particular, the pinching condition (3.1.7) is satisfied.

Finally, in order for the r -normal hyperbolicity assumption (3) of §3.5.1 to be satisfied, we need to make $\mu_{\max} \ll 1$, with μ_{\max} defined in (3.5.3). This is a condition on the underlying compact Riemannian manifold (N, \tilde{g}) , since μ_{\max} is the maximal expansion rate of the geodesic flow of \tilde{g} on the unit cotangent bundle S^*N . To satisfy this condition, we can start with an arbitrary compact Riemannian manifold and multiply its metric by a large constant C^2 ; indeed, if φ_t is the geodesic flow on the original manifold, then $\varphi_{C^{-1}t}$ is the geodesic flow on the rescaled manifold and the resulting μ_{\max} is divided by C .

Chapter 4

Global asymptotics of waves and resonances for black holes and their perturbations

4.1 Introduction

The subject of this chapter are decay properties of solutions to the wave equation for the rotating Kerr (cosmological constant $\Lambda = 0$) and Kerr–de Sitter ($\Lambda > 0$) black holes, as well as for their stationary perturbations. In the recent decade, there has been a lot of progress in understanding the upper bounds on these solutions, producing a polynomial decay rate $\mathcal{O}(t^{-3})$ for Kerr and an exponential decay rate $\mathcal{O}(e^{-\nu t})$ for Kerr–de Sitter (the latter is modulo constant functions). The weaker decay for $\Lambda = 0$ is explained by the presence of an asymptotically Euclidean infinite end; however, this polynomial decay comes from low frequency contributions.

We instead concentrate on the decay of solutions with initial data localized at *high frequencies* $\sim \lambda \gg 1$; it is related to the geometry of the *trapped set* \tilde{K} , consisting of lightlike geodesics that never escape to the spatial infinity or through the event horizons. The trapped set for both Kerr and Kerr–de Sitter metrics is *r-normally hyperbolic*, and this dynamical property is stable under stationary perturbations of the metric – see §4.3.6. The key quantities associated to such trapping are the minimal and maximal transversal expansion rates $0 < \nu_{\min} \leq \nu_{\max}$, see (4.2.9), (4.2.10). Using Chapter 3, we show the exponential decay rate $\mathcal{O}(\lambda^{1/2}e^{-(\nu_{\min}-\varepsilon)t/2}) + \mathcal{O}(\lambda^{-\infty})$, valid for $t = \mathcal{O}(\log \lambda)$ (Theorem 4.1). This bound is new for the Kerr case, complementing Price’s law.

Our methods give a more precise microlocal description of long time propagation of high frequency solutions. In Theorem 4.2, we split a solution $u(t)$ into two approximate solutions to the wave equation, $u_{\Pi}(t)$ and $u_R(t)$, with the rate of decay of $u_{\Pi}(t)$ between $e^{-(\nu_{\max}+\varepsilon)t/2}$ and $e^{-(\nu_{\min}-\varepsilon)t/2}$ and $u_R(t)$ bounded from above by $\lambda e^{-(\nu_{\min}-\varepsilon)t}$, all modulo $\mathcal{O}(\lambda^{-\infty})$ errors. This splitting is achieved using the Fourier integral operator Π constructed in Chapter 3

using the global dynamics of the flow.

For the $\Lambda > 0$ case, we furthermore study resonances, or *quasi-normal modes*, the complex frequencies z of solutions to the wave equation of the form $e^{-izt}v(x)$. Under a pinching condition $\nu_{\max} < 2\nu_{\min}$ which is numerically verified to be true for a large range of parameters (see Figure 4.2(a)), we show existence of a band of quasi-normal modes satisfying a Weyl law – Theorem 4.3. In particular, this provides a large family of exact high frequency solutions to the wave equation that decay no faster than $e^{-(\nu_{\max}+\varepsilon)t/2}$. We finally compare our theoretical prediction on the imaginary parts of resonances in the band with the exact quasi-normal modes for Kerr computed by the authors of [13], obtaining remarkable agreement – see Figure 4.2(b).

Theorems 4.1–4.3 are related to the resonance expansion and quantization condition proved for the slowly rotating Kerr–de Sitter in Chapter 2. In this chapter, however, we use dynamical assumptions stable under perturbations, rather than complete integrability of geodesic flow on Kerr(–de Sitter), and do not recover the precise results of Chapter 2.

Statement of results. The Kerr(–de Sitter) metric, described in detail in §4.3.1, depends on three parameters, M (mass), a (speed of rotation), and Λ (cosmological constant). We assume that the dimensionless quantities a/M and ΛM^2 lie in a small neighborhood (see Figure 4.1(a)) of either the Schwarzschild(–de Sitter) case,

$$a = 0, \quad 9\Lambda M^2 < 1, \tag{4.1.1}$$

or the subextremal Kerr case

$$\Lambda = 0, \quad |a| < M. \tag{4.1.2}$$

Our results apply as long as certain dynamical conditions are satisfied, and likely hold for a larger range of parameters, see the remark following Proposition 4.3.2. To facilitate the discussion of perturbations, we adopt the abstract framework of §4.2.2, with the spacetime $\tilde{X}_0 = \mathbb{R}_t \times X_0$ and a Lorentzian metric \tilde{g} on \tilde{X}_0 which is stationary in the sense that ∂_t is Killing. The space slice X_0 is noncompact because of the spatial infinity and/or event horizon(s); to measure the distance to those, we use a function $\mu \in C^\infty(X_0; (0, \infty))$, such that $X_\delta := \{\mu > \delta\}$ is compact for each $\delta > 0$. For the exact Kerr(–de Sitter metric), the function μ is defined in (4.3.6).

We study solutions to the wave equation in \tilde{X}_0 ,

$$\square_{\tilde{g}}u(t) = 0, \quad t \geq 0; \quad u|_{t=0} = f_0, \quad \partial_t u|_{t=0} = f_1, \tag{4.1.3}$$

with $f_0, f_1 \in C_0^\infty(X_0)$ and the time variable shifted so that the metric continues smoothly past the event horizons – see (4.3.43). To simplify the statements, and because our work focuses on the phenomena driven by the trapped set, we only study the behavior of solutions in X_{δ_1} for some small $\delta_1 > 0$. Define the energy norm

$$\|u(t)\|_{\mathcal{E}} := \|u(t)\|_{H^1(X_{\delta_1})} + \|\partial_t u(t)\|_{L^2(X_{\delta_1})}. \tag{4.1.4}$$

Theorem 4.1. Fix $T, N > 0$, $\varepsilon, \delta_1 > 0$, and let (\tilde{X}_0, \tilde{g}) be the Kerr(-de Sitter) metric with M, a, Λ near one of the cases (4.1.1) or (4.1.2), or its small stationary perturbation as discussed in §4.3.6 (the maximal size of the perturbation depending on T, N).

Assume that $f_0(\lambda), f_1(\lambda) \in C_0^\infty(X_{\delta_1})$ are localized at frequency $\sim \lambda \rightarrow \infty$ in the sense of (4.1.6). Then the solution u_λ to (4.1.3) with initial data f_0, f_1 satisfies the bound

$$\|u_\lambda(t)\|_\varepsilon \leq C(\lambda^{1/2}e^{-(\nu_{\min}-\varepsilon)t/2} + \lambda^{-N})\|u_\lambda(0)\|_\varepsilon, \quad 0 \leq t \leq T \log \lambda. \quad (4.1.5)$$

Here we say that $f = f(\lambda)$ is localized at frequencies $\sim \lambda$, if for each coordinate neighborhood U in X_0 and each $\chi \in C_0^\infty(U)$, the Fourier transforms $\widehat{\chi f}(\xi)$ in the corresponding coordinate system satisfy for each N ,

$$\int_{\mathbb{R}^3 \setminus \{C_{U,\chi}^{-1} \leq |\xi| \leq C_{U,\chi}\}} \langle \xi \rangle^N |\widehat{\chi f}(\xi)|^2 d\xi = \mathcal{O}(\lambda^{-N}), \quad (4.1.6)$$

where $C_{U,\chi} > 0$ is a constant independent of λ . For the proof, it is more convenient to use *semiclassical rescaling* of frequencies $\xi \mapsto h\xi$, where $h = \lambda^{-1} \rightarrow 0$ is the semiclassical parameter, and the notion of h -wavefront set $\text{WF}_h(f) \subset T^*X_0$. The requirement that f_j is microlocalized at frequencies $\sim h^{-1}$ is then equivalent to stating that $\text{WF}_h(f_j)$ is contained in a fixed compact subset of $T^*X_0 \setminus 0$, with 0 denoting the zero section; see §4.2.1 for details.

The main component of the proof of Theorem 4.1 is the following

Theorem 4.2. Under the assumptions of Theorem 4.1, for each families $f_0(h), f_1(h) \in C_0^\infty(X_{\delta_1})$ with $\text{WF}_h(f_j)$ contained in a fixed compact subset of $T^*X_0 \setminus 0$ and $u(h)$ the corresponding solution to (4.1.3), for t_0 large enough there exists a decomposition

$$u(t, x) = u_\Pi(t, x) + u_R(t, x), \quad t_0 \leq t \leq T \log(1/h), \quad x \in X_{\delta/2},$$

such that $\square_{\tilde{g}} u_\Pi(t), \square_{\tilde{g}} u_R(t)$ are $\mathcal{O}(h^N)_{H_h^N}$ on X_{δ_1} uniformly in $t \in [t_0, T \log(1/h)]$, and we have uniformly in $t_0 \leq t \leq T \log(1/h)$,

$$\|u_\Pi(t_0)\|_\varepsilon \leq Ch^{-1/2}\|u(0)\|_\varepsilon, \quad (4.1.7)$$

$$\|u_\Pi(t)\|_\varepsilon \leq Ce^{-(\nu_{\min}-\varepsilon)t/2}\|u_\Pi(t_0)\|_\varepsilon + Ch^N\|u(0)\|_\varepsilon, \quad (4.1.8)$$

$$\|u_\Pi(t)\|_\varepsilon \geq C^{-1}e^{-(\nu_{\max}+\varepsilon)t/2}\|u_\Pi(t_0)\|_\varepsilon - Ch^N\|u(0)\|_\varepsilon, \quad (4.1.9)$$

$$\|u_R(t)\|_\varepsilon \leq C(h^{-1}e^{-(\nu_{\min}-\varepsilon)t} + h^N)\|u(0)\|_\varepsilon. \quad (4.1.10)$$

The decomposition $u = u_\Pi + u_R$ is achieved in §4.2.4 using the Fourier integral operator Π constructed for r -normally hyperbolic trapped sets in Chapter 3. The component u_Π enjoys additional microlocal properties, such as localization on the outgoing tail and approximately solving a pseudodifferential equation – see the proof of Theorem 4.4 in §4.2.4 and §3.8.5. We note that (4.1.9) gives a *lower bound* on the rate of decay of the approximate solution u_Π , if $\|u_\Pi(t_0)\|_\varepsilon$ is not too small compared to $\|u(0)\|_\varepsilon$, and the existence of a large family of solutions with the latter property follows from the construction of u_Π . We remark that

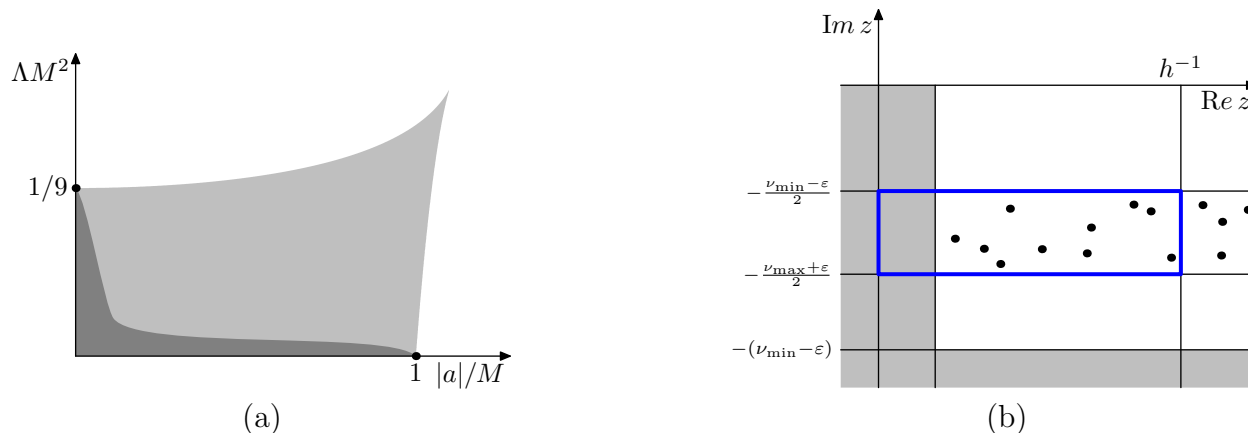

Figure 4.1: (a) The numerically computed admissible range of parameters for the subextremal Kerr–de Sitter black hole (light shaded) and a schematic depiction of the range of parameters to which our results apply (dark shaded). (b) An illustration of Theorem 4.3; (4.1.13) counts resonances in the outlined box and the unshaded regions above and below the box represent (4.1.11).

Theorems 4.1 and 4.2 are completely independent from the behavior of linear waves at low frequency. In fact, we do not even use the boundedness in time of solutions for the wave equation, assuming merely that they grow at most exponentially (which is trivially true in our case); this suffices since $\mathcal{O}(h^\infty)$ remainders overcome such growth for $t = \mathcal{O}(\log(1/h))$. If a boundedness statement is available, then our results can be extended to all times, though the corresponding rate of decay stays fixed for $t \gg \log(1/h)$ because of the $\mathcal{O}(h^\infty)$ term.

To formulate the next result, we restrict to the case $\Lambda > 0$, or its small stationary perturbation. In this case, the metric has two event horizons and we consider the discrete set Res of *resonances*, as defined for example in [128]. As a direct application of Theorems 3.1 and 3.2, we obtain two gaps and a band of resonances in between with a Weyl law (see Figure 4.1(b)):

Theorem 4.3. *Let (\tilde{X}_0, \tilde{g}) be the Kerr–de Sitter metric with M, a, Λ near one of the cases (4.1.1) or (4.1.2) and $\Lambda > 0$, or its small stationary perturbation as discussed in §4.3.6. Fix $\varepsilon > 0$. Then:*

1. *For h small enough, there are no resonances in the region*

$$\{|\text{Re } z| \geq h^{-1}, \text{Im } z \in [-(\nu_{\min} - \varepsilon), 0] \setminus \frac{1}{2}(-(\nu_{\max} + \varepsilon), -(\nu_{\min} - \varepsilon))\} \quad (4.1.11)$$

and the corresponding semiclassical scattering resolvent, namely the inverse of the operator (4.3.54), is bounded by Ch^{-2} for z in this region.

2. *Under the pinching condition*

$$\nu_{\max} < 2\nu_{\min} \quad (4.1.12)$$

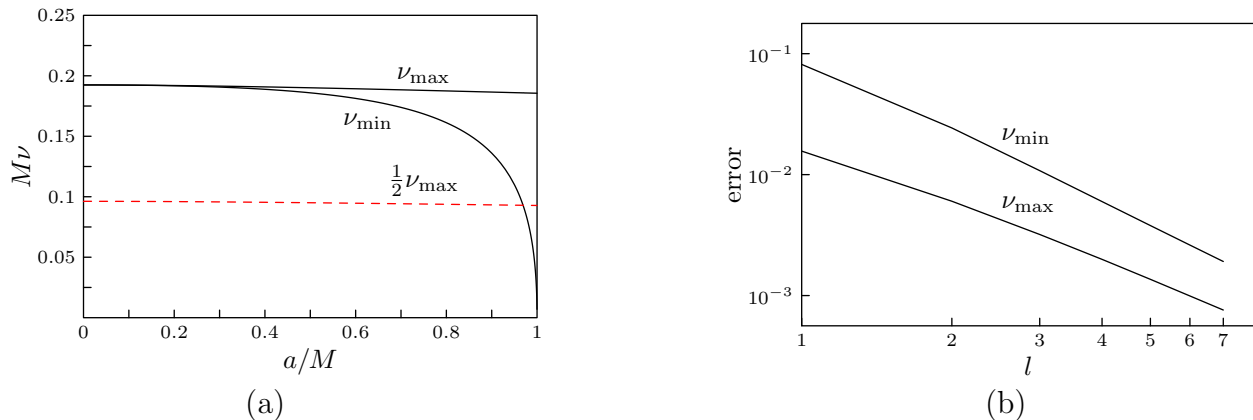

Figure 4.2: (a) Numerically computed minimal and maximal transversal expansion rates for $\Lambda = 0$ and the range of a for which (4.1.12) holds. (b) A log-log plot of the relative errors $\frac{|\nu_{\min}^R(l) - \nu_{\min}/2|}{\nu_{\min}^R(l)}$, $\frac{|\nu_{\max}^R(l) - \nu_{\max}/2|}{\nu_{\max}^R(l)}$, where $\nu_{\min}^R(l), \nu_{\max}^R(l)$ are the minimal/maximal imaginary parts of resonances in the first band defined by (4.1.14).

and for ε small enough so that $\nu_{\max} + \varepsilon < 2(\nu_{\min} - \varepsilon)$, we have the Weyl law

$$\#(\text{Res} \cap \{0 \leq \text{Re } z \leq h^{-1}, \text{Im } z \in [-(\nu_{\min} - \varepsilon), 0]\}) = (2\pi h)^{1-n} (c_{\tilde{K}} + o(1)) \quad (4.1.13)$$

as $h \rightarrow 0$, where $c_{\tilde{K}}$ is the symplectic volume of a certain part of the trapped set \tilde{K} , see (4.2.16).

The pinching condition (4.1.12) is true for the non-rotating case $a = 0$, since $\nu_{\min} = \nu_{\max}$ there (see Proposition 4.3.8). However, it is violated for the nearly extremal case $M - |a| \ll M$, at least for Λ small enough; in fact, as $|a|/M \rightarrow 1$, ν_{\max} stays bounded away from zero, while ν_{\min} converges to zero – see Proposition 4.3.9 and Figure 4.2(a). Note that $(\nu_{\min} - \varepsilon)/2$ is the size of the resonance free strip and thus gives the minimal rate of exponential decay of linear waves on Kerr–de Sitter, modulo terms coming from finitely many resonances, by means of a resonance expansion – see for example [128, Lemma 3.1].

To demonstrate the sharpness of the size of the band of resonances $\{\text{Im } \omega \in \frac{1}{2}[-\nu_{\max} - \varepsilon, -\nu_{\min} + \varepsilon]\}$, we use the exact quasi-normal modes for the Kerr metric computed (formally, since one cannot meromorphically continue the resolvent in the $\Lambda = 0$ case; however, one could consider the case of a very small positive Λ) by Berti–Cardoso–Starinets [13]. Similarly to the quantization condition of Chapter 2, these resonances ω_{mlk} are indexed by three integer parameters $m \geq 0$ (depth), $l \geq 0$ (angular energy), and $k \in [-l, l]$ (angular momentum). The parameter l roughly corresponds to the real part of the resonance and the parameter m , to its imaginary part. We define

$$\nu_{\min}^R(l) := \min_{k \in [-l, l]} (-\text{Im } \omega_{0lk}), \quad \nu_{\max}^R(l) := \max_{k \in [-l, l]} (-\text{Im } \omega_{0lk}). \quad (4.1.14)$$

We compare $\nu_{\min}^R(l), \nu_{\max}^R(l)$ with $\nu_{\min}/2, \nu_{\max}/2$ and plot the supremum of the relative error over $a/M \in [0, 0.95]$ for different values of l ; the error decays like $\mathcal{O}(l^{-1})$ – see Figure 4.2(b).

Previous work. We give an overview of results on decay and non-decay on black hole backgrounds; for a more detailed discussion of previous results on normally hyperbolic trapped sets and resonance asymptotics, see §3.1.

The study of boundedness of solutions to the wave equation for the Schwarzschild ($\Lambda = a = 0$) black hole was initiated in [131, 77] and decay results for this case have been proved in [16, 32, 86, 83]. The slowly rotating Kerr case ($\Lambda = 0, |a| \ll M$) was considered in [4, 28, 30, 121, 122, 125, 92, 82], and the full subextremal Kerr case ($\Lambda = 0, |a| < M$) in [52, 53, 29, 31, 104, 105] – see [31] for a more detailed overview. In either case the decay is polynomial in time, with the optimal decay rate $\mathcal{O}(t^{-3})$. A decay rate of $\mathcal{O}(t^{-2l-3})$, known as *Price’s Law*, was proved in [41, 42] for linear waves on the Schwarzschild black hole for solutions living on the l -th spherical harmonic; the constant in the $\mathcal{O}(\cdot)$ depends on l . Our Theorem 4.1 improves on these decay rates in the high frequency regime $l = \lambda \gg 1$, for times $\mathcal{O}(\log \lambda)$.

The extremal Kerr case ($\Lambda = 0, |a| = M$) was recently studied for axisymmetric solutions in [5], with a weaker upper bound due to the degeneracy of the event horizon. The earlier work [6, 7] suggests that one cannot expect the $\mathcal{O}(t^{-3})$ decay to hold in the extremal case. In the high frequency regime studied here, we do not expect to get exponential decay due to the presence of slowly damped geodesics near the event horizon, see Figure 4.2(a) above.

The Schwarzschild–de Sitter case ($\Lambda > 0, a = 0$) was considered in [103, 17, 33, 90], proving an exponential decay rate at all frequencies, a quantization condition for resonances, and a resonance expansion, all relying on separation of variables techniques. In Chapters 1 and 2 and [46], a same flavor of results was proved for the slowly rotating Kerr–de Sitter ($\Lambda > 0, |a| \ll M$). The problem was then studied from a more geometric perspective, aiming for results that do not depend on symmetries and apply to perturbations of the metric – the resonance free strip of [132] for normally hyperbolic trapping, the gluing method of [38], and the analysis of the event horizons and low frequencies of [128] together give an exponential decay rate which is stable under perturbations, for $\Lambda > 0, |a| < \frac{\sqrt{3}}{2}M$, provided that there are no resonances in the upper half-plane except for the resonance at zero. Our Theorem 4.3 provides detailed information on the behavior of resonances below the resonance free strip of [132], without relying on the symmetries of the problem.

Finally, we mention the the Kerr–AdS case ($\Lambda < 0$). The metric in this case exhibits strong (elliptic) trapping, which suggests that the decay of linear waves is very slow because of the high frequency contributions. A logarithmic upper bound was proved in [68], and existence of resonances exponentially close to the real axis and a logarithmic lower bound were established in [54, 69].

Quasi-normal modes (QNMs) of black holes have a rich history of study in the physics literature, see [79]. The exact QNMs of Kerr black holes were computed in [13], which we use for Figure 4.2(b). The high-frequency approximation for QNMs, using separation of variables and WKB techniques, has been obtained in [134, 133, 67]. In particular, for the nearly extremal Kerr case their size of the resonance free strip agrees with Proposition 4.3.9;

moreover, they find a large number of QNMs with small imaginary parts, which correspond to a positive proportion of the Liouville tori on the trapped set lying close to the event horizon. See [134] for an overview of the recent physics literature on the topic. We finally remark that the speed of rotation of an astrophysical black hole (NGC 1365) has recently been accurately measured in [102], yielding a high speed of rotation: $a/M \geq 0.84$ at 90% confidence.

Structure of the chapter. In §4.2, we study semiclassical properties of solutions to the wave equation on stationary Lorentzian metrics with noncompact space slices. We operate under the geometric and dynamical assumptions of §4.2.2; while these assumptions are motivated by Kerr(–de Sitter) metrics and their stationary perturbations, no explicit mention of these metrics is made. The analysis of §4.2 works in a fixed compact subset of the space slice, and the results apply under microlocal assumptions in this compact subset (namely, outgoing property of solutions to the wave equation for Theorems 4.1–4.2 and meromorphic continuation of the scattering resolvent with an outgoing parametrix for Theorem 4.3) which are verified for our specific applications in §4.3.4 and §4.3.5. In §4.2.3, we reduce the problem to the space slice via the stationary d’Alembert–Beltrami operator and show that some of the assumptions of §§3.4.1, 3.5.1 are satisfied. In §4.2.4, we use the methods of Chapter 3 to prove asymptotics of outgoing solutions to the wave equation.

Next, §4.3 contains the applications of Chapter 3 and §4.2 to the Kerr(–de Sitter) metrics and their perturbations. In §4.3.1, we define the metrics and establish their basic properties, verifying in particular the geometric assumptions of §4.2.2. In §4.3.2, we show that the trapping is r -normally hyperbolic, verifying the dynamical assumptions of §4.2.2. In §4.3.3, we study in greater detail trapping in the Schwarzschild(–de Sitter) case $a = 0$ and in the nearly extremal Kerr case $\Lambda = 0, a = M - \epsilon$, in particular showing that the pinching condition (4.1.12) is violated for the latter case; we also study numerically some properties of the trapping for the general Kerr case. In §4.3.4, we study solutions to the wave equation on Kerr(–de Sitter), using the results of §4.2.4 to prove Theorems 4.1 and 4.2. In §4.3.5, we use the results of Chapter 3 and [128] to prove Theorem 4.3 for Kerr–de Sitter. Finally, in §4.3.6, we explain why our results apply to small smooth stationary perturbations of Kerr(–de Sitter) metrics.

4.2 General framework for linear waves

4.2.1 Semiclassical preliminaries

We start by briefly reviewing some notions of semiclassical analysis, following §3.3. For a detailed introduction to the subject, the reader is directed to [137].

Let X be an n -dimensional manifold without boundary. Following §3.3.1, we consider the class $\Psi^k(X)$ of all semiclassical pseudodifferential operators with classical symbols of order k . If X is noncompact, we impose no restrictions on how fast the corresponding symbols can grow at spatial infinity. The microsupport of a pseudodifferential operator $A \in \Psi^k(X)$, also

known as its h -wavefront set $\text{WF}_h(A)$, is a closed subset of the fiber-radially compactified cotangent bundle $\overline{T^*X}$. We denote by $\Psi^{\text{comp}}(X)$ the class of all pseudodifferential operators whose wavefront set is a compact subset of T^*X (and in particular lies away from the fiber infinity). Finally, we say that $A = \mathcal{O}(h^\infty)$ microlocally in some open set $U \subset \overline{T^*X}$, if $\text{WF}_h(A) \cap U = \emptyset$; similar notions apply to tempered distributions and operators below.

Using pseudodifferential operators, we can study microlocalization of h -tempered distributions, namely families of distributions $u(h) \in \mathcal{D}'(X)$ having a polynomial in h bound in some Sobolev norms on compact sets, by means of the wavefront set $\text{WF}_h(u) \subset \overline{T^*X}$. Using Schwartz kernels, we can furthermore study h -tempered operators $B(h) : C_0^\infty(X_1) \rightarrow \mathcal{D}'(X_2)$ and their wavefront sets $\text{WF}_h(B) \subset \overline{T^*}(X_1 \times X_2)$. Besides pseudodifferential operators (whose wavefront set in this framework is the image under the diagonal embedding $\overline{T^*X} \rightarrow \overline{T^*}(X \times X)$ of the wavefront set used in the previous paragraph) we will use the class $I^{\text{comp}}(\Lambda)$ of compactly supported and compactly microlocalized Fourier integral operators associated to some canonical relation $\Lambda \subset T^*(X \times X)$, see §3.3.2; for $B \in I^{\text{comp}}(\Lambda)$, $\text{WF}_h(B) \subset \Lambda$ is compact.

The h -wavefront set of an h -tempered family of distributions $u(h)$ can be characterized using the semiclassical Fourier transform

$$\mathcal{F}_h v(\xi) = (2\pi h)^{-n/2} \int_{\mathbb{R}^n} e^{-\frac{i}{h}x \cdot \xi} v(x) dx, \quad v \in \mathcal{S}'(\mathbb{R}^n).$$

We have $(x, \xi) \notin \text{WF}_h(u)$ if and only if there exists a coordinate neighborhood U_x of x in X , a function $\chi \in C_0^\infty(U_x)$ with $\chi(x) \neq 0$, and a neighborhood U_ξ of ξ in $\overline{T_x^*X}$ such that if we consider χu as a function on \mathbb{R}^n using the corresponding coordinate system, then for each N ,

$$\int_{U_\xi} \langle \xi \rangle^N |\mathcal{F}_h(\chi u)(\xi)|^2 d\xi = \mathcal{O}(h^N). \quad (4.2.1)$$

The proof is done analogously to [71, Theorem 18.1.27].

One additional concept that we need is microlocalization of distributions depending on the time variable that varies in a set whose size can grow with h . Assume that $u(t; h)$ is a family of distributions on $(-\varepsilon, T(h) + \varepsilon) \times X$, where $\varepsilon > 0$ is fixed and $T(h) > 0$ depends on h . For $s \in [0, T(h)]$, define the shifted function

$$u_s(t; h) = u(s + t; h), \quad t \in (-\varepsilon, \varepsilon),$$

so that $u_s \in \mathcal{D}'((-\varepsilon, \varepsilon) \times X)$ is a distribution on a time interval independent of h . We then say that u is h -tempered uniformly in t , if u_s is h -tempered uniformly in s , that is, for each $\chi \in C_0^\infty((-\varepsilon, \varepsilon) \times X)$, there exist constants C and N such that $\|\chi u_s\|_{H_h^{-N}} \leq Ch^{-N}$ for all $s \in [0, T(h)]$. Next, we define the projected wavefront set $\widetilde{\text{WF}}_h(u) \subset \overline{T^*X \times \mathbb{R}_\tau}$, where τ is the momentum corresponding to t and $\overline{T^*X \times \mathbb{R}_\tau}$ is the fiber-radial compactification of the vector bundle $T^*X \times \mathbb{R}_\tau$, with \mathbb{R}_τ part of the fiber, as follows: (x, ξ, τ) does not lie in $\widetilde{\text{WF}}_h(u)$ if and only if there exists a neighborhood U of (x, ξ, τ) in $\overline{T^*X \times \mathbb{R}_\tau}$ such that

$$\sup_{s \in [0, T(h)]} \|Au_s\|_{L^2} = \mathcal{O}(h^\infty)$$

for each compactly supported $A \in \Psi^{\text{comp}}((-\varepsilon, \varepsilon) \times X)$ such that $\text{WF}_h(A) \cap ((-\varepsilon, \varepsilon)_t \times U) = \emptyset$. If $T(h)$ is independent of h , then $\widetilde{\text{WF}}_h(u)$ is simply the closure of the projection of $\text{WF}_h(u)$ onto the (x, ξ, τ) variables. The notion of $\widetilde{\text{WF}}_h$ makes it possible to talk about u being microlocalized inside, or being $\mathcal{O}(h^\infty)$, on subsets of $\overline{T^*}((-\varepsilon, T(h) + \varepsilon) \times X)$ independent of t .

We now discuss restrictions to space slices. Assume that $u(h) \in \mathcal{D}'((-\varepsilon, T(h) + \varepsilon) \times X)$ is h -tempered uniformly in t and moreover, $\widetilde{\text{WF}}_h(u)$ does not intersect the spatial fiber infinity $\{\xi = 0, \tau = \infty\}$. Then u (as well as all its derivatives in t) is a smooth function of t with values in $\mathcal{D}'(X)$, $u(t)$ is h -tempered uniformly in $t \in [0, T(h)]$, and

$$\text{WF}_h(u(t)) \subset \{(x, \xi) \mid \exists \tau : (x, \xi, \tau) \in \widetilde{\text{WF}}_h(u)\},$$

uniformly in $t \in [0, T(h)]$. One can see this using (4.2.1) and the formula for the Fourier transform of the restriction w of $v \in \mathcal{S}'(\mathbb{R}^{n+1})$ to the hypersurface $\{t = 0\}$:

$$\mathcal{F}_h w(\xi) = (2\pi h)^{-1/2} \int_{\mathbb{R}} \mathcal{F}_h v(\xi, \tau) d\tau.$$

4.2.2 General assumptions

In this section, we study Lorentzian metrics whose space slice is noncompact, and define r -normal hyperbolicity and the dynamical quantities ν_{\min}, ν_{\max} in this case.

Geometric assumptions. We assume that:

- (1) (\tilde{X}_0, \tilde{g}) is an $n+1$ dimensional Lorentzian manifold of signature $(1, n)$, and $\tilde{X}_0 = \mathbb{R}_t \times X_0$, where X_0 , the space slice, is a manifold without boundary;
- (2) the metric \tilde{g} is stationary in the sense that its coefficients do not depend on t , or equivalently, ∂_t is a Killing field;
- (3) the space slices $\{t = \text{const}\}$ are spacelike, or equivalently, the covector dt is timelike with respect to the dual metric \tilde{g}^{-1} on $T^*\tilde{X}_0$;

The (nonsemiclassical) principal symbol of the d'Alembert–Beltrami operator $\square_{\tilde{g}}$ (without the negative sign), denoted by $\tilde{p}(\tilde{x}, \tilde{\xi})$, is

$$\tilde{p}(\tilde{x}, \tilde{\xi}) = -\tilde{g}_{\tilde{x}}^{-1}(\tilde{\xi}, \tilde{\xi}), \tag{4.2.2}$$

here $\tilde{x} = (t, x)$ denotes a point in \tilde{X}_0 and $\tilde{\xi} = (\tau, \xi)$ a covector in $T_{\tilde{x}}^*\tilde{X}_0$. The Hamiltonian flow of \tilde{p} is the (rescaled) geodesic flow on $T_{\tilde{x}}^*\tilde{X}_0$; we are in particular interested in nontrivial lightlike geodesics, i.e. the flow lines of $H_{\tilde{p}}$ on the set $\{\tilde{p} = 0\} \setminus 0$, where 0 denotes the zero section.

Note that we do not assume that the vector field ∂_t is timelike, since this is false inside the ergoregion for rotating black holes. Because of this, the intersections of the sets $\{\tau = \text{const}\}$,

invariant under the geodesic flow, with the energy surface $\{\tilde{p} = 0\}$ need not be compact in the ξ direction, and it is possible that ξ will blow up in finite time along a flow line of $H_{\tilde{p}}$, while x stays in a compact subset of X_0 .¹ We consider instead the rescaled flow

$$\tilde{\varphi}^s := \exp(sH_{\tilde{p}}/\partial_\tau\tilde{p}) \quad \text{on } \{\tilde{p} = 0\} \setminus 0. \quad (4.2.3)$$

Here $\partial_\tau\tilde{p}(\tilde{x}, \tilde{\xi}) = -2\tilde{g}_{\tilde{x}}^{-1}(\tilde{\xi}, dt)$ never vanishes on $\{\tilde{p} = 0\} \setminus 0$ by assumption (3). Since $H_{\tilde{p}}t = \partial_\tau\tilde{p}$, the variable t grows linearly with unit rate along the flow $\tilde{\varphi}^s$. The flow lines of (4.2.3) exist for all s as long as x stays in a compact subset of X_0 . The flow is homogeneous, which makes it possible to define it on the cosphere bundle $S^*\tilde{X}_0$, which is the quotient of $T^*\tilde{X}_0 \setminus 0$ by the action of dilations. Finally, the flow preserves the restriction of the symplectic form to the tangent bundle of $\{\tilde{p} = 0\}$.

We next assume the existence of a ‘defining function of infinity’ μ on the space slice with a concavity property:

(4) there exists a function $\mu \in C^\infty(X_0)$ such that $\mu > 0$ on X_0 , for $\delta > 0$ the set

$$X_\delta := \{\mu > \delta\} \subset X_0 \quad (4.2.4)$$

is compactly contained in X_0 , and there exists $\delta_0 > 0$ such that for each flow line $\gamma(s)$ of (4.2.3), and with μ naturally defined on $T^*\tilde{X}_0$,

$$\mu(\gamma(s)) < \delta_0, \quad \partial_s\mu(\gamma(s)) = 0 \quad \implies \quad \partial_s^2\mu(\gamma(s)) < 0. \quad (4.2.5)$$

We now define the trapped set:

Definition 4.2.1. *Let $\gamma(s)$ be a maximally extended flow line of (4.2.3). We say that $\gamma(s)$ is trapped as $s \rightarrow +\infty$, if there exists $\delta > 0$ such that $\mu(\gamma(s)) > \delta$ for all $s \geq 0$ (and as a consequence, $\gamma(s)$ exists for all $s \geq 0$). Denote by $\tilde{\Gamma}_-$ the union of all γ trapped as $s \rightarrow +\infty$; similarly, we define the union $\tilde{\Gamma}_+$ of all γ trapped as $s \rightarrow -\infty$. Define the trapped set $\tilde{K} := \tilde{\Gamma}_+ \cap \tilde{\Gamma}_- \subset \{\tilde{p} = 0\} \setminus 0$.*

If $\mu(\gamma(s)) < \delta_0$ and $\partial_s\mu(\gamma(s)) \leq 0$ for some s , then it follows from assumption (4) that $\gamma(s)$ is not trapped as $s \rightarrow +\infty$. Also, if $\gamma(s)$ is not trapped as $s \rightarrow +\infty$, then $\mu(\gamma(s)) < \delta_0$ and $\partial_s\mu(\gamma(s)) < 0$ for $s > 0$ large enough. It follows that $\tilde{\Gamma}_\pm$ are closed conic subsets of $\{\tilde{p} = 0\} \setminus 0$, and $\tilde{K} \subset \{\mu \geq \delta_0\}$.

We next split the light cone $\{\tilde{p} = 0\} \setminus 0$ into the sets \mathcal{C}_+ and \mathcal{C}_- of positively and negatively time oriented covectors:

$$\mathcal{C}_\pm = \{\tilde{p} = 0\} \cap \{\pm\partial_\tau\tilde{p} > 0\}. \quad (4.2.6)$$

Since $\partial_\tau\tilde{p}$ never vanishes on $\{\tilde{p} = 0\} \setminus 0$ by assumption (3), we have $\{\tilde{p} = 0\} \setminus 0 = \mathcal{C}_+ \sqcup \mathcal{C}_-$.

We fix the sign of τ on the trapped set, in particular requiring that $\tilde{K} \subset \{\tau \neq 0\}$:

¹The simplest example of such behavior is $\tilde{p} = x\xi^2 + 2\xi\tau - \tau^2$, considering the geodesic starting at $x = t = \tau = 0, \xi = 1$.

(5) $\tilde{K} \cap \mathcal{C}_\pm \subset \{\pm\tau < 0\}$.

Dynamical assumptions. We now formulate the assumptions on the dynamical structure of the flow (4.2.3). They are analogous to the assumptions of §3.5.1 and related to them in §4.2.3 below. We start by requiring that $\tilde{\Gamma}_\pm$ are regular:

- (6) for a large constant r , $\tilde{\Gamma}_\pm$ are codimension 1 orientable C^r submanifolds of $\{\tilde{p} = 0\} \setminus 0$;
- (7) $\tilde{\Gamma}_\pm$ intersect transversely inside $\{\tilde{p} = 0\} \setminus 0$, and the intersections $\tilde{K} \cap \{t = \text{const}\}$ are symplectic submanifolds of $T^*\tilde{X}_0$.

We next define a natural invariant decomposition of the tangent space to $\{\tilde{p} = 0\}$ at \tilde{K} . Let $(T\tilde{\Gamma}_\pm)^\perp$ be the symplectic complement of the tangent space to $\tilde{\Gamma}_\pm$. Since $\tilde{\Gamma}_\pm$ has codimension 2 and is contained in $\{\tilde{p} = 0\}$, $(T\tilde{\Gamma}_\pm)^\perp$ is a two-dimensional vector subbundle of $T(T^*\tilde{X}_0)$ containing $H_{\tilde{p}}$. Since $H_{\tilde{p}}t \neq 0$ on $\{\tilde{p} = 0\} \setminus 0$, we can define the one-dimensional vector subbundles of $T(T^*\tilde{X}_0)$

$$\tilde{\mathcal{V}}_\pm := (T\tilde{\Gamma}_\pm)^\perp \cap \{dt = 0\}. \quad (4.2.7)$$

Since $\tilde{\Gamma}_\pm$ is a codimension 1 submanifold of $\{\tilde{p} = 0\}$ and $H_{\tilde{p}}$ is tangent to $\tilde{\Gamma}_\pm$, we see that $\tilde{\Gamma}_\pm$ is coisotropic and then $\tilde{\mathcal{V}}_\pm$ are one-dimensional subbundles of $T\tilde{\Gamma}_\pm$; moreover, since $\partial_t \in T\tilde{\Gamma}_\pm$, we find $\tilde{\mathcal{V}}_\pm \subset \{d\tau = 0\}$. Since $\tilde{K} \cap \{t = \text{const}\}$ is symplectic, we have

$$T_{\tilde{K}}\tilde{\Gamma}_\pm = T\tilde{K} \oplus \tilde{\mathcal{V}}_\pm|_{\tilde{K}}, \quad T_{\tilde{K}}\tilde{p}^{-1}(0) = T\tilde{K} \oplus \tilde{\mathcal{V}}_-|_{\tilde{K}} \oplus \tilde{\mathcal{V}}_+|_{\tilde{K}}. \quad (4.2.8)$$

Since the flow $\tilde{\varphi}^s$ from (4.2.3) maps the space slice $\{t = t_0\}$ to $\{t = t_0 + s\}$ and $H_{\tilde{p}}$ is tangent to $T\tilde{\Gamma}_\pm$, we see that the splittings (4.2.8) are invariant under $\tilde{\varphi}^s$.

We now formulate the dynamical assumptions on the linearization of the flow $\tilde{\varphi}^s$ with respect to the splitting (4.2.8). Define the minimal expansion rate in the transverse direction ν_{\min} as the supremum of all ν for which there exists a constant C such that

$$\sup_{\tilde{\rho} \in \tilde{K}} \|d\tilde{\varphi}^{\mp s}(\tilde{\rho})|_{\mathcal{V}_\pm}\| \leq Ce^{-\nu s}, \quad s \geq 0, \quad (4.2.9)$$

with $\|\cdot\|$ denoting any smooth t -independent norm on the fibers of $T(T^*\tilde{X}_0)$, homogeneous of degree zero with respect to dilations on $T^*\tilde{X}_0$. Similarly, define ν_{\max} as the infimum of all ν for which there exists a constant $c > 0$ such that

$$\inf_{\tilde{\rho} \in \tilde{K}} \|d\tilde{\varphi}^{\mp s}(\tilde{\rho})|_{\mathcal{V}_\pm}\| \geq ce^{-\nu s}, \quad s \geq 0. \quad (4.2.10)$$

We now formulate the dynamical assumption of r -normal hyperbolicity:

- (8) $\nu_{\min} > r\mu_{\max}$, where μ_{\max} is the maximal expansion rate of the flow along \tilde{K} , defined as the infimum of all ν for which there exists a constant C such that

$$\sup_{\tilde{\rho} \in \tilde{K}} \|d\tilde{\varphi}^s(\tilde{\rho})|_{T\tilde{K}}\| \leq Ce^{\nu s}, \quad s \in \mathbb{R}. \quad (4.2.11)$$

The large constant r determines how many terms we need to obtain in semiclassical expansions, and how many derivatives of these terms need to exist – see Chapter 3. Theorem 4.3 simply needs r to be large (in principle, depending on the dimension), while Theorems 4.1 and 4.2 require r to be large enough depending on N, T . For exact Kerr(–de Sitter) metrics, our assumptions are satisfied for all r , but a small perturbation will satisfy them for some fixed large r depending on the size of the perturbation.

4.2.3 Reduction to the space slice

We now put a Lorentzian manifold (\tilde{X}_0, \tilde{g}) satisfying assumptions of §4.2.2 into the framework of Chapter 3. Consider the stationary d’Alembert–Beltrami operator $P_{\tilde{g}}(\omega)$, $\omega \in \mathbb{C}$, the second order semiclassical differential operator on the space slice X_0 obtained by replacing hD_t by $-\omega$ in the semiclassical d’Alembert–Beltrami operator $h^2\Box_{\tilde{g}}$. The principal symbol of $P_{\tilde{g}}(\omega)$ is given by

$$\mathbf{p}(x, \xi; \omega) = \tilde{p}(t, x, -\omega, \xi),$$

where \tilde{p} is defined in (4.2.2) and the right-hand side does not depend on t . We will show that the operator $P_{\tilde{g}}(\omega)$ satisfies a subset of the assumptions of §§3.4.1, 3.5.1.

First of all, we need to understand the solutions in ω to the equation $\mathbf{p} = 0$. Let

$$p(x, \xi) \in C^\infty(T^*X_0 \setminus 0)$$

be the unique real solution ω to the equation $\mathbf{p}(x, \xi; \omega) = 0$ such that $(t, x, -\omega, \xi) \in \mathcal{C}_+$, with the positive time oriented light cone \mathcal{C}_+ defined in (4.2.6). The existence and uniqueness of such solution follows from assumption (3) in §4.2.2, and we also find from the definition of \mathcal{C}_+ that

$$\partial_\omega \mathbf{p}(x, \xi; p(x, \xi)) < 0, \quad (x, \xi) \in T^*X_0 \setminus 0. \quad (4.2.12)$$

We can write \mathcal{C}_+ as the graph of p :

$$\mathcal{C}_+ = \{(t, x, -p(x, \xi), \xi) \mid t \in \mathbb{R}, (x, \xi) \in T^*X_0 \setminus 0\}.$$

The level sets of p are not compact if ∂_t is not timelike. To avoid dealing with the fiber infinity, we use assumption (5) in §4.2.2 to identify a bounded region in T^*X_0 invariant under the flow and containing the trapped set:

Lemma 4.2.2. *There exists an open conic subset $\mathcal{W} \subset \mathcal{C}_+$, independent of t , such that $\tilde{K} \cap \mathcal{C}_+ \subset \mathcal{W}$, the closure of \mathcal{W} in \mathcal{C}_+ is contained in $\{\tau < 0\}$, and \mathcal{W} is invariant under the flow (4.2.3).*

Proof. Consider a conic neighborhood \mathcal{W}_0 of $\tilde{K} \cap \mathcal{C}_+$ in \mathcal{C}_+ independent of t and such that the closure of \mathcal{W}_0 is contained in $\{\mu > \delta_0/2\} \cap \{\tau < 0\}$; this is possible by assumption (5) and since \tilde{K} is contained in $\{\mu \geq \delta_0\}$. Let $\mathcal{W} \subset \mathcal{C}_+$ be the union of all maximally extended flow lines of (4.2.3) passing through \mathcal{W}_0 . Then \mathcal{W} is an open conic subset of \mathcal{C}_+ containing $\tilde{K} \cap \mathcal{C}_+$

and invariant under the flow (4.2.3). It remains to show that each point $(\tilde{x}, \tilde{\xi}) \in \mathcal{C}_+ \cap \{\tau \geq 0\}$ has a neighborhood that does not intersect \mathcal{W} . To see this, note that the corresponding trajectory $\gamma(s)$ of (4.2.3) does not lie in $\tilde{\Gamma}_+ \cup \tilde{\Gamma}_-$ (as otherwise, the projection of $\gamma(s)$ onto the cosphere bundle would converge to \tilde{K} as $s \rightarrow +\infty$ or $s \rightarrow -\infty$, by Lemma 3.4.1; it remains to use assumption (5) and the fact that τ is constant on $\gamma(s)$). We then see that $\gamma(s)$ escapes for both $s \rightarrow +\infty$ and $s \rightarrow -\infty$ and does not intersect the closure of \mathcal{W}_0 and same is true for nearby trajectories; therefore, a neighborhood of $(\tilde{x}, \tilde{\xi})$ does not intersect \mathcal{W} . \square

Arguing similarly (using an open conic subset \mathcal{W}'_0 of \mathcal{C}_+ such that $\overline{\mathcal{W}_0} \subset \mathcal{W}'_0$ and $\overline{\mathcal{W}'_0} \subset \{\mu > \delta_0/2\} \cap \{\tau < 0\}$), we construct an open conic subset \mathcal{W}' of \mathcal{C}_+ independent of t and such that

$$\tilde{K} \cap \mathcal{C}_+ \subset \mathcal{W}, \quad \overline{\mathcal{W}} \subset \mathcal{W}', \quad \overline{\mathcal{W}'} \subset \{\tau < 0\},$$

and $\mathcal{W}, \mathcal{W}'$ are invariant under the flow (4.2.3). Now, take small $\delta_1 > 0$ and define

$$\begin{aligned} \tilde{\mathcal{U}} &:= \mathcal{C}_+ \cap \{|1 + \tau| < \delta_1\} \cap \mathcal{W} \cap \{\mu > \delta_1\}, \\ \tilde{\mathcal{U}}' &:= \mathcal{C}_+ \cap \{|1 + \tau| < 2\delta_1\} \cap \mathcal{W}' \cap \{\mu > \delta_1/2\}. \end{aligned} \tag{4.2.13}$$

Then $\tilde{\mathcal{U}}, \tilde{\mathcal{U}}'$ are open subsets of \mathcal{C}_+ convex under the flow (4.2.3), $\tilde{K} \cap \{|1 + \tau| < \delta_1\} \subset \tilde{\mathcal{U}}$ (note that $\tilde{K} \cap \{\tau < 0\} \subset \mathcal{C}_+$ by assumption (5)), and the closure of $\tilde{\mathcal{U}}$ is contained in $\tilde{\mathcal{U}}'$. Moreover, the projections of $\mathcal{U}, \mathcal{U}'$ onto the (x, τ, ξ) variables are bounded because $\mathcal{W}, \mathcal{W}'$ are conic and $\overline{\mathcal{W}}, \overline{\mathcal{W}'} \subset \{\tau \neq 0\}$.

Let $\mathcal{U} \Subset \mathcal{U}' \Subset T^*X_0$ be the projections of $\tilde{\mathcal{U}}, \tilde{\mathcal{U}}'$ onto the (x, ξ) variables, so that

$$\tilde{\mathcal{U}} = \{(t, x, -p(x, \xi), \xi) \mid t \in \mathbb{R}, (x, \xi) \in \mathcal{U}\},$$

and similarly for \mathcal{U}' . Note that $\mathcal{U} \subset \{|p - 1| < \delta_1\}$ and $\mathcal{U}' \subset \{|p - 1| < 2\delta_1\}$. Since \mathcal{U}' is bounded, and by (4.2.12), for $\delta_1 > 0$ small enough and $(x, \xi) \in \mathcal{U}'$, $p(x, \xi)$ is the only solution to the equation $\mathbf{p}(x, \xi; \omega) = 0$ in $\{\omega \in \mathbb{C} \mid |\omega - 1| < 2\delta_1\}$.

We now study the Hamiltonian flow of p . Since

$$\partial_{x, \xi} p(x, \xi) = -\frac{\partial_{x, \xi} \mathbf{p}(x, \xi, p(x, \xi))}{\partial_{\omega} \mathbf{p}(x, \xi, p(x, \xi))},$$

and for each t ,

$$-\partial_{\omega} \mathbf{p}(x, \xi, p(x, \xi)) = \partial_{\tau} \tilde{p}(t, x, -p(x, \xi), \xi),$$

we see that the flow of H_p is the projection of the rescaled geodesic flow (4.2.3) on \mathcal{C}_+ : for $(x, \xi) \in T^*X_0 \setminus 0$,

$$\tilde{\varphi}^s(t, x, -p(x, \xi), \xi) = (t + s, x(s), -p(x, \xi), \xi(s)), \quad (x(s), \xi(s)) = e^{sH_p}(x, \xi). \tag{4.2.14}$$

We now verify some of the assumptions of §3.4.1. We let X be an n -dimensional manifold containing X_0 (for the Kerr–de Sitter metric it is constructed in §4.3.5) and consider the

volume form $d\widetilde{\text{Vol}}$ on X_0 related to the volume form $d\widetilde{\text{Vol}}$ on \widetilde{X}_0 generated by \tilde{g} by the formula $d\widetilde{\text{Vol}} = dt \wedge d\text{Vol}$. The operator $P_{\tilde{g}}(\omega)$ is a semiclassical pseudodifferential operator depending holomorphically on $\omega \in \Omega := \{|\omega - 1| < 2\delta_1\}$ and \mathbf{p} is its semiclassical principal symbol. We do not specify the spaces $\mathcal{H}_1, \mathcal{H}_2$ here and do not establish any mapping or Fredholm properties of $P_{\tilde{g}}(\omega)$; for our specific applications it is done in §4.3.5. Except for these mapping properties, the assumptions (1), (2), and (5)–(9) of §3.4.1 are satisfied, with $\mathcal{U}, \mathcal{U}'$ defined above, $[\alpha_0, \alpha_1] := [1 - \delta_1/2, 1 + \delta_1/2]$, and the incoming/outgoing tails Γ_{\pm} on the space slice given by (for each t)

$$\Gamma_{\pm} = \{(x, \xi) \mid (t, x, -p(x, \xi), \xi) \in \widetilde{\Gamma}_{\pm} \cap \{|1 + \tau| \leq \delta_1\} \cap \overline{\mathcal{W}} \cap \{\mu \geq \delta_1\}\}, \quad (4.2.15)$$

and similarly for the trapped set $K = \Gamma_+ \cap \Gamma_-$.

Finally, the dynamical assumptions of §3.5.1 are also satisfied, as follows directly from (4.2.14) and the dynamical assumptions of §4.2.2. Note that the subbundles \mathcal{V}_{\pm} of $T\Gamma_{\pm}$ defined in §3.5.1 coincide with the subbundles $\widetilde{\mathcal{V}}_{\pm}$ of $T\widetilde{\Gamma}_{\pm}$ defined in §4.2.7 under the identification $T_{(x, \xi)}(T^*X_0) \simeq T_{(t, x, -p(x, \xi), \xi)}(T^*\widetilde{X}_0) \cap \{dt = d\tau = 0\}$, and the expansion rates $\nu_{\min}, \nu_{\max}, \mu_{\max}$ defined in (4.2.9)–(4.2.11) coincide with those defined in (3.5.1)–(3.5.3).

To relate the constants for the Weyl laws in Theorem 4.3 and Theorem 3.2, we note that for $[a, b] \subset (1 - \delta_1/2, 1 + \delta_1/2)$,

$$\text{Vol}_{\sigma}(K \cap p^{-1}[a, b]) = \text{Vol}_{\tilde{\sigma}}(\widetilde{K} \cap \{a \leq -\tau \leq b\} \cap \{t = \text{const}\}).$$

Here Vol_{σ} and $\text{Vol}_{\tilde{\sigma}}$ stand for symplectic volume forms of order $2n - 2$ on T^*X_0 and $T^*\widetilde{X}_0$, respectively. The constant $c_{\widetilde{K}}$ from Theorem 4.3 is then given by

$$c_{\widetilde{K}} = \text{Vol}_{\tilde{\sigma}}(\widetilde{K} \cap \{0 \leq \tau \leq 1\} \cap \{t = \text{const}\}). \quad (4.2.16)$$

4.2.4 Applications to linear waves

In this section, we apply the results of Chapter 3 to understand the decay properties of linear waves; Theorem 4.4 below forms the base for the proofs of Theorems 4.1 and 4.2 in §4.3.4.

Consider a family of approximate solutions $u(h) \in \mathcal{D}'((-1, T(h) + 1)_t \times X_0)$ to the wave equation

$$h^2 \square_{\tilde{g}} u(h) = \mathcal{O}(h^{\infty})_{C^{\infty}}. \quad (4.2.17)$$

Here $h \ll 1$ is the semiclassical parameter and $T(h) > 0$ depends on h (for our particular application, $T(h) = T \log(1/h)$ for some constant T). We assume that u is h -tempered uniformly in t , as defined in §4.2.1. Then by the elliptic estimate (see for instance Proposition 3.3.2), u is microlocalized on the light cone:

$$\widetilde{\text{WF}}_h(u) \subset \{\tilde{p} = 0\}, \quad (4.2.18)$$

where $\widetilde{\text{WF}}_h(u)$ is defined in §4.2.1. By the restriction statement in §4.2.1, u is a smooth function of t with values in h -tempered distributions on X_0 . Moreover, we obtain for $0 <$

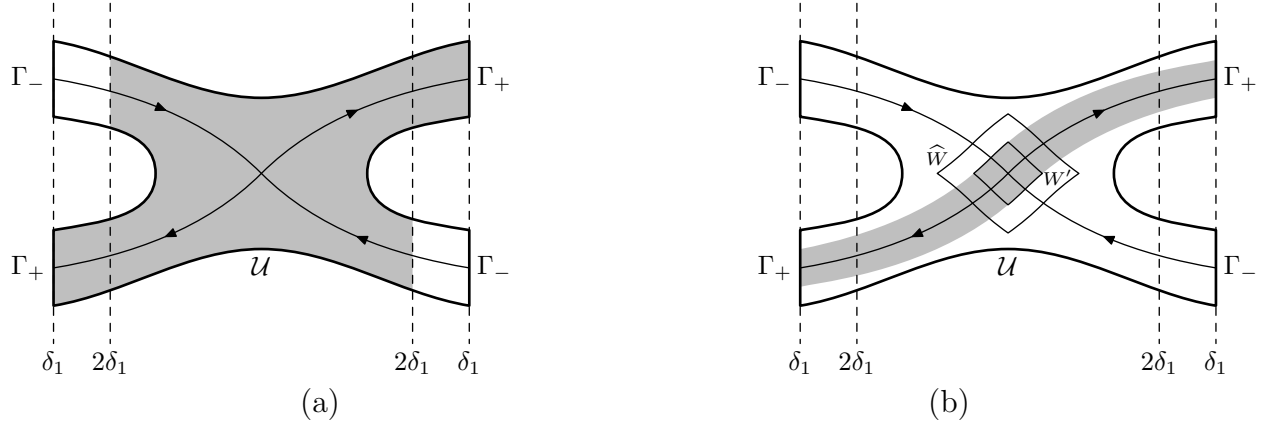

Figure 4.3: The phase space picture of the flow, showing shaded $\text{WF}_h(\mathbf{u}(t))$ for (a) all t and (b) all $t \geq t_1$, for u satisfying Definition 4.2.3. The horizontal axis corresponds to μ .

$\delta_1 < \delta_2$ small enough and each $t_0 \in [0, T(h)]$,

$$\begin{aligned} \|u(t_0)\|_{H_x^1(X_{\delta_2})} &\leq C\|u\|_{H_{t,x}^1([t_0-1, t_0+1] \times X_{\delta_1})} + \mathcal{O}(h^\infty), \\ \|u\|_{L_t^2[t_0-1, t_0+1]L_x^2(X_{\delta_1})} &\leq C\|u\|_{L_t^\infty[t_0-1, t_0+1]L_x^2(X_{\delta_1})} + \mathcal{O}(h^\infty). \end{aligned} \quad (4.2.19)$$

The second of these inequalities is trivial; the first one is done by applying the standard energy estimate for the wave equation to the function $\chi(t - t_0)u$, with $\chi \in C_0^\infty(-\epsilon, \epsilon)$ equal to 1 near 0 and $\epsilon > 0$ small depending on δ_1, δ_2 .

We furthermore restrict ourselves to the following class of outgoing solutions, see Figure 4.3(a):

Definition 4.2.3. Fix small $\delta_1 > 0$. A solution u to (4.2.17), h -tempered uniformly in $t \in (-1, T(h)+1)$, is called *outgoing*, if its projected wavefront set $\widetilde{\text{WF}}_h(u)$, defined in §4.2.1, satisfies (for $\tilde{\mathcal{U}}$ defined in (4.2.13))

$$\widetilde{\text{WF}}_h(u) \cap \{\mu > \delta_1\} \subset \tilde{\mathcal{U}} \cap \{|\tau + 1| < \delta_1/4\}, \quad (4.2.20)$$

$$\widetilde{\text{WF}}_h(u) \cap \{\delta_1 \leq \mu \leq 2\delta_1\} \subset \{H_{\bar{p}}\mu \leq 0\}. \quad (4.2.21)$$

The main result of this section is

Theorem 4.4. Fix $T, N, \varepsilon > 0$ and let the assumptions of §4.2.2 hold, including r -normal hyperbolicity with r large depending on T, N . Assume that u is an outgoing solution to (4.2.17), for $t \in (-1, T \log(1/h) + 1)$, and $\|u(t)\|_{H_h^{-N}(X_{\delta_1/2})} = \mathcal{O}(h^{-N})$ uniformly in t . Then for t_0 large enough and independent of h , we can write

$$u(t, x) = u_\Pi(t, x) + u_R(t, x), \quad t_0 \leq t \leq T \log(1/h),$$

such that $h^2\Box_{\tilde{g}}u_{\Pi}, h^2\Box_{\tilde{g}}u_R$ are $\mathcal{O}(h^N)_{H_h^N}$ on X_{δ_1} and, with $\|\cdot\|_{\mathcal{E}}$ defined in (4.1.4),

$$\|u_{\Pi}(t_0)\|_{\mathcal{E}} \leq Ch^{-1/2}\|u(0)\|_{\mathcal{E}} + \mathcal{O}(h^N), \quad (4.2.22)$$

$$\|u_{\Pi}(t)\|_{\mathcal{E}} \leq Ce^{-(\nu_{\min}-\varepsilon)t/2}\|u_{\Pi}(t_0)\|_{\mathcal{E}} + \mathcal{O}(h^N), \quad (4.2.23)$$

$$\|u_{\Pi}(t)\|_{\mathcal{E}} \geq C^{-1}e^{-(\nu_{\max}+\varepsilon)t/2}\|u_{\Pi}(t_0)\|_{\mathcal{E}} - \mathcal{O}(h^N), \quad (4.2.24)$$

$$\|u_R(t)\|_{\mathcal{E}} \leq Ch^{-1}e^{-(\nu_{\min}-\varepsilon)t}\|u(0)\|_{\mathcal{E}} + \mathcal{O}(h^N), \quad (4.2.25)$$

$$\|u(t)\|_{\mathcal{E}} \leq Ce^{\varepsilon t}\|u(0)\|_{\mathcal{E}} + \mathcal{O}(h^N), \quad (4.2.26)$$

all uniformly in $t \in [t_0, T \log(1/h)]$.

For the proof, we assume that the metric is r -normally hyperbolic for all r , and prove the bounds for all T, N (so that $\mathcal{O}(h^N)$ becomes $\mathcal{O}(h^\infty)$); since semiclassical arguments require finitely many derivatives to work, the statement will be true for r large depending on T and N .

We first recall the factorization of Lemma 3.4.3:

$$P_{\tilde{g}}(\omega) = \mathcal{S}(\omega)(P - \omega)\mathcal{S}(\omega) + \mathcal{O}(h^\infty) \quad \text{microlocally near } \mathcal{U}, \quad (4.2.27)$$

where $\mathcal{S}(\omega)$ is a family of pseudodifferential operators elliptic near \mathcal{U} , and such that $\mathcal{S}(\omega)^* = \mathcal{S}(\omega)$ for $\omega \in \mathbb{R}$, and P is a self-adjoint pseudodifferential operator, moreover we assume that it is compactly supported and compactly microlocalized. If we define the self-adjoint pseudodifferential operator $\tilde{\mathcal{S}}$ on \tilde{X}_0 by replacing ω by $-hD_t$ in $\mathcal{S}(\omega)$, then we get

$$h^2\Box_{\tilde{g}} = \tilde{\mathcal{S}}(hD_t + P)\tilde{\mathcal{S}} + \mathcal{O}(h^\infty) \quad \text{microlocally near } \tilde{\mathcal{U}}. \quad (4.2.28)$$

We define

$$\mathbf{u}(t) := (\tilde{\mathcal{S}}u)(t), \quad 0 \leq t \leq T \log(1/h),$$

note that $\mathbf{u}(t)$ and its t -derivatives are bounded uniformly in t with values in h -tempered distributions on X_0 by the discussion of restrictions to space slices in §4.2.1 and by (4.2.18). We have by (4.2.17), (4.2.20), (4.2.21), and (4.2.28),

$$(hD_t + P)\mathbf{u}(t) = \mathcal{O}(h^\infty) \quad \text{microlocally near } X_{\delta_1}, \quad (4.2.29)$$

$$\text{WF}_h(\mathbf{u}(t)) \cap X_{\delta_1} \subset \{|p-1| < \delta_1/4\}, \quad (4.2.30)$$

$$\text{WF}_h(\mathbf{u}(t)) \cap \{\delta_1 \leq \mu \leq 2\delta_1\} \subset \{H_p\mu \leq 0\}, \quad (4.2.31)$$

uniformly in $t \in [0, T \log(1/h)]$.

We next use the construction of Lemma 3.5.1, which (combined with the homogeneity of the flow) gives functions φ_{\pm} defined in a conic neighborhood of K in T^*X_0 , such that $\Gamma_{\pm} = \{\varphi_{\pm} = 0\}$ in this neighborhood, φ_{\pm} are homogeneous of degree zero, and

$$H_p\varphi_{\pm} = \mp c_{\pm}\varphi_{\pm}, \quad \nu_{\min} - \varepsilon < c_{\pm} < \nu_{\max} + \varepsilon, \quad (4.2.32)$$

where c_{\pm} are some smooth functions on the domain of φ_{\pm} . Then for small $\delta > 0$,

$$U_{\delta} := \{|\varphi_+| \leq \delta, |\varphi_-| \leq \delta\}$$

is a small closed conic neighborhood of K in $T^*X_0 \setminus 0$.

We now fix δ small enough so that Theorem 3.3 in §3.7.1 and Proposition 3.7.1 apply, giving a Fourier integral operator $\Pi \in I_{\text{comp}}(\Lambda^{\circ})$ which satisfies the equations

$$\Pi^2 = \Pi + \mathcal{O}(h^{\infty}), \quad [P, \Pi] = \mathcal{O}(h^{\infty}) \quad (4.2.33)$$

microlocally near the set $\widehat{W} \times \widehat{W}$, with

$$\widehat{W} := U_{\delta} \cap \{|p-1| \leq \delta_1/2\}. \quad (4.2.34)$$

Here $\Lambda^{\circ} \subset \Gamma_- \cap \Gamma_+$ is the canonical relation defined in (3.5.12). Also, we define

$$W' := U_{\delta/2} \cap \{|p-1| \leq \delta_1/4\}. \quad (4.2.35)$$

We now derive certain conditions on the microlocalization of u for large enough times, see Figure 4.3(b) (compare with Figure 3.5):

Proposition 4.2.4. *For t_1 large enough independent of h , the function $\mathbf{u}(t)$ satisfies*

$$\text{WF}_h(\mathbf{u}(t)) \cap \widehat{W} \subset \{|\varphi_+| < \delta/2\}, \quad (4.2.36)$$

$$\text{WF}_h(\mathbf{u}(t)) \cap \Gamma_- \subset W', \quad (4.2.37)$$

uniformly in $t \in [t_1, T \log(1/h)]$.

Proof. Consider $(x, \xi) \in \text{WF}_h(\mathbf{u}(t)) \cap X_{2\delta_1}$ for some $t \in [t_1, T \log(1/h)]$. Put $\gamma(s) = e^{sH_p}(x, \xi)$. Then by propagation of singularities (see for example Proposition 3.3.4) for the equation (4.2.29), we see that either there exists $s_0 \in [-t_1, 0]$ such that $\gamma(s_0) \in \{\delta_1 \leq \mu \leq 2\delta_1\} \cap \text{WF}_h(u(t+s_0))$, or $\gamma(s) \in X_{2\delta_1}$ for all $s \in [-t_1, 0]$. However, in the first of these two cases, by (4.2.31) we have $\gamma(s_0) \in \{\mu \leq 2\delta_1\} \cap \{H_p\mu \leq 0\}$, which implies that $\gamma(0) \in \{\mu \leq 2\delta_1\}$ by assumption (4) in §4.2.2, a contradiction. Therefore,

$$e^{tH_p}(x, \xi) \in X_{2\delta_1}, \quad t \in [-t_1, 0].$$

It remains to note that for t_1 large enough,

$$\begin{aligned} e^{-t_1 H_p}(\widehat{W} \cap \{|\varphi_+| \geq \delta/2\}) \cap X_{2\delta_1} &= \emptyset; \\ e^{t_1 H_p}(\Gamma_- \cap \{|p-1| < \delta_1/4\}) \cap X_{2\delta_1} &\subset W'; \end{aligned}$$

the first of these statements follows from the fact that $\widehat{W} \cap \{|\varphi_+| \geq \delta/2\}$ is a compact set not intersecting Γ_+ , and the second one, from Lemma 3.4.1. \square

By (4.2.29), (4.2.33), and (4.2.37), and since $\text{WF}_h(\Pi) \subset \Gamma_- \times \Gamma_+$ we have uniformly in $t \in [t_1, T \log(1/h)]$,

$$(hD_t + P)\Pi\mathbf{u}(t) = \mathcal{O}(h^\infty) \quad \text{microlocally near } \widehat{W}. \quad (4.2.38)$$

By Proposition 3.6.1 and §3.6.2, we have

$$\|\Pi\mathbf{u}(t)\|_{L^2} \leq Ch^{-1/2}\|\mathbf{u}(t)\|_{L^2}. \quad (4.2.39)$$

We now use the methods of §3.8 to prove a microlocal version of Theorem 4.4 near the trapped set:

Proposition 4.2.5. *There exist compactly supported $A_0, A_1 \in \Psi^{\text{comp}}(X_0)$ microlocalized inside \widehat{W} , elliptic on W' , and such that for $t \in [t_1, T \log(1/h)]$,*

$$\|A_0\Pi\mathbf{u}(t)\|_{L^2} \leq Ce^{-(\nu_{\min}-\varepsilon)t/2}\|A_0\Pi\mathbf{u}(t_1)\|_{L^2} + \mathcal{O}(h^\infty), \quad (4.2.40)$$

$$\|A_0\Pi\mathbf{u}(t)\|_{L^2} \geq C^{-1}e^{-(\nu_{\max}+\varepsilon)t/2}\|A_0\Pi\mathbf{u}(t_1)\|_{L^2} - \mathcal{O}(h^\infty), \quad (4.2.41)$$

$$\|A_1(1 - \Pi)\mathbf{u}(t)\|_{L^2} \leq Ch^{-1}e^{-(\nu_{\min}-\varepsilon)t}\|A_0\mathbf{u}(t_1)\|_{L^2} + \mathcal{O}(h^\infty), \quad (4.2.42)$$

$$\|A_1\mathbf{u}(t)\|_{L^2} \leq Ce^{\varepsilon t}\|A_0\mathbf{u}(t_1)\|_{L^2} + \mathcal{O}(h^\infty). \quad (4.2.43)$$

Proof. We will use the operators Θ_\pm, Ξ constructed in Proposition 3.7.1. The microlocalization statements we make will be uniform in $t \in [t_1, T \log(1/h)]$.

We first prove (4.2.42), following the proof of Proposition 3.8.1. Put

$$\mathbf{v}(t) := \Xi\mathbf{u}(t).$$

Then similarly to (3.8.14), we find

$$(1 - \Pi)\mathbf{u}(t) = \Theta_- \mathbf{v}(t) + \mathcal{O}(h^\infty) \quad \text{microlocally near } \widehat{W}.$$

By (4.2.29) and (4.2.38),

$$(hD_t + P)(1 - \Pi)\mathbf{u}(t) = \mathcal{O}(h^\infty) \quad \text{microlocally near } \widehat{W}.$$

Similarly to Proposition 3.8.3, we use the commutation relation $[P, \Theta_-] = -ih\Theta_-Z_- + \mathcal{O}(h^\infty)$ together with propagation of singularities for the operator Θ_- to find

$$(hD_t + P - ihZ_-)\mathbf{v}(t) = \mathcal{O}(h^\infty) \quad \text{microlocally near } \widehat{W}. \quad (4.2.44)$$

Here $Z_- \in \Psi^{\text{comp}}(X_0)$ satisfies $\sigma(Z_-) = c_-$ near \widehat{W} .

Let $\mathcal{X}_- \in \Psi^{\text{comp}}(X_0)$ be the operator used in §3.8.2, satisfying $\text{WF}_h(\mathcal{X}_-) \Subset \widehat{W}$, $\sigma(\mathcal{X}_-) \geq 0$ everywhere, and $\sigma(\mathcal{X}_-) > 0$ on W' . Similarly to (3.8.18), we get

$$\frac{1}{2}\partial_t \langle \mathcal{X}_- \mathbf{v}(t), \mathbf{v}(t) \rangle + \langle \mathcal{Y}_- \mathbf{v}(t), \mathbf{v}(t) \rangle = \mathcal{O}(h^\infty), \quad (4.2.45)$$

where

$$\mathcal{Y}_- = \frac{1}{2}(Z_-^* \mathcal{X}_- + \mathcal{X}_- Z_-) + \frac{1}{2ih}[P, \mathcal{X}_-]$$

satisfies $\text{WF}_h(\mathcal{Y}_-) \Subset \widehat{W}$, and similarly to (3.8.19) we have

$$\sigma(\mathcal{Y}_-) \geq (\nu_{\min} - \varepsilon)\sigma(\mathcal{X}_-) \quad \text{near } \text{WF}_h(\mathbf{v}(t)),$$

and the inequality is strict on W' . Similarly to Lemma 3.8.4, by sharp Gårding inequality we get

$$\langle (\mathcal{Y}_- - (\nu_{\min} - \varepsilon)\mathcal{X}_-)\mathbf{v}(t), \mathbf{v}(t) \rangle \geq \|A_1 \mathbf{v}(t)\|_{L^2}^2 - Ch\|A'_0 \mathbf{v}(t)\|_{L^2}^2 - \mathcal{O}(h^\infty) \quad (4.2.46)$$

for an appropriate choice of A_1 and some $A'_0 \in \Psi^{\text{comp}}(X_0)$ microlocalized inside \widehat{W} . Also similarly to Lemma 3.8.4, by propagation of singularities for the equation (4.2.44) we get for t_1 large enough,

$$\|A'_0 \mathbf{v}(t)\|_{L^2}^2 \leq C\|A_0 \mathbf{v}(t_1)\|_{L^2}^2 + \mathcal{O}(h^\infty), \quad t \in [t_1, 2t_1], \quad (4.2.47)$$

$$\|A'_0 \mathbf{v}(t)\|_{L^2}^2 \leq C\|A_1 \mathbf{v}(t - t_1)\|_{L^2}^2 + \mathcal{O}(h^\infty), \quad t \geq 2t_1, \quad (4.2.48)$$

for an appropriate choice of A_0 . By (4.2.45) and (4.2.46), we see that

$$\begin{aligned} \langle \mathcal{X}_- \mathbf{v}(t), \mathbf{v}(t) \rangle &\leq C e^{-2(\nu_{\min} - \varepsilon)t} \langle \mathcal{X}_- \mathbf{v}(t_1), \mathbf{v}(t_1) \rangle - C^{-1} \int_{t_1}^t e^{-2(\nu_{\min} - \varepsilon)(t-s)} \|A_1 \mathbf{v}(s)\|_{L^2}^2 ds \\ &\quad + Ch \int_{t_1}^t e^{-2(\nu_{\min} - \varepsilon)(t-s)} \|A'_0 \mathbf{v}(s)\|_{L^2}^2 ds + \mathcal{O}(h^\infty). \end{aligned}$$

Breaking the second integral on the right-hand side in two pieces and estimating each of them separately by (4.2.47) and (4.2.48), we get for an appropriate choice of A_0 ,

$$\langle \mathcal{X}_- \mathbf{v}(t), \mathbf{v}(t) \rangle \leq C e^{-2(\nu_{\min} - \varepsilon)t} \|A_0 \mathbf{v}(t_1)\|_{L^2}^2 + \mathcal{O}(h^\infty).$$

We can moreover assume that \mathcal{X}_- has the form $A_1^* A_1 + \mathcal{X}_1^* \mathcal{X}_1 + \mathcal{O}(h^\infty)$ for some pseudodifferential operator \mathcal{X}_1 ; this can be arranged since $\sigma(\mathcal{X}_-) > 0$ on $\text{WF}_h(A_1)$ and the argument of §3.8.2 only depends on the principal symbol of \mathcal{X}_- , which can be taken to be the square of a smooth function. Then $\|A_1 \mathbf{v}(t)\|_{L^2}^2 \leq \langle \mathcal{X}_- \mathbf{v}(t), \mathbf{v}(t) \rangle + \mathcal{O}(h^\infty)$ and we get

$$\|A_1 \mathbf{v}(t)\|_{L^2} \leq C e^{-\nu_{\min} - \varepsilon)t} \|A_0 \mathbf{v}(t_1)\|_{L^2} + \mathcal{O}(h^\infty). \quad (4.2.49)$$

To prove (4.2.42), it remains to note that $(1 - \Pi)\mathbf{u}(t) = \mathbf{v}(t) + \mathcal{O}(h^\infty)$ microlocally near \widehat{W} and $\|\mathbf{v}(t_1)\|_{L^2} \leq Ch^{-1}\|\mathbf{u}(t_1)\|_{L^2}$ by part 1 of Proposition 3.6.12.

To prove (4.2.43), we argue similarly to (4.2.45), but use the equation (4.2.29) instead of (4.2.44). We get

$$\frac{1}{2} \partial_t \langle \mathcal{X}_- \mathbf{u}(t), \mathbf{u}(t) \rangle + \langle \mathcal{Y}'_- \mathbf{u}(t), \mathbf{u}(t) \rangle = \mathcal{O}(h^\infty),$$

where

$$\mathcal{Y}'_ = \frac{1}{2ih}[P, \mathcal{X}_-]$$

satisfies $\text{WF}_h(\mathcal{Y}'_-) \Subset \widehat{W}$ and

$$\sigma(\mathcal{Y}'_-) \geq -\varepsilon\sigma(\mathcal{X}_-) \quad \text{near } \text{WF}_h(\mathbf{u}(t)),$$

and the inequality is strict on W' . The remainder of the proof of (4.2.43) proceeds exactly as the proof of (4.2.49).

Finally, we prove (4.2.40) and (4.2.41), following the proof of Proposition 3.8.2. Let $\mathcal{X}_+ \in \Psi^{\text{comp}}(X_0)$ be the operator defined in §3.8.3, satisfying in particular $\text{WF}_h(\mathcal{X}_+) \Subset \widehat{W}$, $\sigma(\mathcal{X}_+) \geq 0$ everywhere, and $\sigma(\mathcal{X}_+) > 0$ on W' . Similarly to (3.8.33), we get from (4.2.38) that for an appropriate choice of A_0 ,

$$\frac{1}{2}\partial_t \langle \mathcal{X}_+ \Pi \mathbf{u}(t), \Pi \mathbf{u}(t) \rangle + \langle \mathcal{Z}_+ \Pi \mathbf{u}(t), \Pi \mathbf{u}(t) \rangle = \mathcal{O}(h) \|A_0 \Pi \mathbf{u}(t)\|_{L^2}^2 + \mathcal{O}(h^\infty), \quad (4.2.50)$$

where $\mathcal{Z}_+ \in \Psi^{\text{comp}}(X_0)$, $\text{WF}_h(\mathcal{Z}_+) \Subset \widehat{W}$,

$$\frac{\nu_{\min} - \varepsilon}{2} \sigma(\mathcal{X}_+) \leq \sigma(\mathcal{Z}_+) \leq \frac{\nu_{\max} + \varepsilon}{2} \sigma(\mathcal{X}_+) \quad \text{near } \text{WF}_h(\Pi \mathbf{u}(t)),$$

and both inequalities are strict on $W' \cap \text{WF}_h(\Pi \mathbf{u}(t))$. By Lemma 3.8.7, we deduce that

$$\begin{aligned} \langle \mathcal{Z}_+ \Pi \mathbf{u}(t), \Pi \mathbf{u}(t) \rangle &\geq \frac{\nu_{\min} - \varepsilon}{2} \langle \mathcal{X}_+ \Pi \mathbf{u}(t), \Pi \mathbf{u}(t) \rangle + \|A_0 \Pi \mathbf{u}(t)\|_{L^2}^2 - \mathcal{O}(h^\infty), \\ \langle \mathcal{Z}_+ \Pi \mathbf{u}(t), \Pi \mathbf{u}(t) \rangle &\leq \frac{\nu_{\max} + \varepsilon}{2} \langle \mathcal{X}_+ \Pi \mathbf{u}(t), \Pi \mathbf{u}(t) \rangle - \|A_0 \Pi \mathbf{u}(t)\|_{L^2}^2 + \mathcal{O}(h^\infty) \end{aligned}$$

By (4.2.50), we find

$$\begin{aligned} (\partial_t + (\nu_{\min} - \varepsilon)) \langle \mathcal{X}_+ \Pi \mathbf{u}(t), \Pi \mathbf{u}(t) \rangle &\leq \mathcal{O}(h^\infty), \\ (\partial_t + (\nu_{\max} + \varepsilon)) \langle \mathcal{X}_+ \Pi \mathbf{u}(t), \Pi \mathbf{u}(t) \rangle &\geq -\mathcal{O}(h^\infty). \end{aligned}$$

Therefore,

$$\begin{aligned} \langle \mathcal{X}_+ \Pi \mathbf{u}(t), \Pi \mathbf{u}(t) \rangle &\leq C e^{-(\nu_{\min} - \varepsilon)t} \langle \mathcal{X}_+ \Pi \mathbf{u}(t_1), \Pi \mathbf{u}(t_1) \rangle + \mathcal{O}(h^\infty), \\ \langle \mathcal{X}_+ \Pi \mathbf{u}(t), \Pi \mathbf{u}(t) \rangle &\geq C^{-1} e^{-(\nu_{\max} + \varepsilon)t} \langle \mathcal{X}_+ \Pi \mathbf{u}(t_1), \Pi \mathbf{u}(t_1) \rangle - \mathcal{O}(h^\infty). \end{aligned}$$

To prove (4.2.39) and (4.2.40), it remains to note that

$$\begin{aligned} \langle \mathcal{X}_+ \Pi \mathbf{u}(t), \Pi \mathbf{u}(t) \rangle &\geq C^{-1} \|A_0 \Pi \mathbf{u}(t)\|_{L^2}^2 - \mathcal{O}(h^\infty), \\ \langle \mathcal{X}_+ \Pi \mathbf{u}(t), \Pi \mathbf{u}(t) \rangle &\leq C \|A_0 \Pi \mathbf{u}(t)\|_{L^2}^2 + \mathcal{O}(h^\infty); \end{aligned}$$

the first of these statements follows by Lemma 3.8.7 and the second one is arranged by choosing A_0 to be elliptic on $\text{WF}_h(\mathcal{X}_+)$. \square

Proof of Theorem 4.4. To construct the component $u_{\Pi}(t)$, we use $\Pi\mathbf{u}(t)$ together with the Schrödinger propagator $e^{-itP/h}$. Since $P^* = P$ and P is compactly supported and compactly microlocalized, the operator $e^{-itP/h}$ quantizes the flow e^{tH_p} in the sense of Proposition 3.3.1. Since $\text{WF}_h(\Pi\mathbf{u}(t)) \subset \Gamma_+$, we have by (4.2.38),

$$(hD_t + P)e^{-it_1P/h}\Pi\mathbf{u}(t) = \mathcal{O}(h^\infty) \quad \text{on } X_{\delta_1}, \quad t \geq t_1, \quad (4.2.51)$$

if t_1 is large enough so that

$$e^{-t_1H_p}(\Gamma_+ \cap X_{\delta_1} \cap \{|p-1| < \delta_1/4\}) \subset W'; \quad (4.2.52)$$

such t_1 exists by Lemma 3.4.1. We then take an elliptic parametrix $\tilde{\mathcal{S}}'$ of $\tilde{\mathcal{S}}$ near $\tilde{\mathcal{U}}$ (see Proposition 3.3.3) and define

$$u_{\Pi}(t) := \tilde{\mathcal{S}}'(e^{-it_1P/h}\Pi\mathbf{u}(t-t_1)), \quad t \in [t_0-1, T \log(1/h)], \quad t_0 := 2t_1 + 1. \quad (4.2.53)$$

Then by (4.2.28) and (4.2.51) we get

$$h^2\Box_{\tilde{g}}u_{\Pi} = \mathcal{O}(h^\infty) \quad \text{on } X_{\delta_1},$$

uniformly in $t \in [t_0, T \log(1/h)]$. Put

$$u_R(t) := u(t) - u_{\Pi}(t), \quad t \in [t_0, T \log(1/h)],$$

then $h^2\Box_{\tilde{g}}u_R = \mathcal{O}(h^\infty)$ on X_{δ_1} as well.

It remains to prove (4.2.22)–(4.2.26). Since $\text{WF}_h(\Pi\mathbf{u}(t)) \subset \Gamma_+$ and by (4.2.52), we find

$$\|\tilde{\mathcal{S}}u_{\Pi}(t)\|_{L^2(X_{\delta_1})} \leq C\|A_0\Pi\mathbf{u}(t-t_1)\|_{L^2} + \mathcal{O}(h^\infty);$$

here A_0 is the operator from Proposition 4.2.5. Since $[P, \Pi] = \mathcal{O}(h^\infty)$ microlocally near $\widehat{W} \times \widehat{W}$, and by (4.2.29) and (4.2.37) (replacing t_1 by $s \in [0, t_1]$ in the definition of u_{Π} and differentiating in s) we get

$$\tilde{\mathcal{S}}u_{\Pi}(t) = \Pi\mathbf{u}(t) + \mathcal{O}(h^\infty) \quad \text{microlocally near } \widehat{W}. \quad (4.2.54)$$

Therefore,

$$\|A_0\Pi\mathbf{u}(t)\|_{L^2} \leq C\|\tilde{\mathcal{S}}u_{\Pi}(t)\|_{L^2(X_{\delta_1})} + \mathcal{O}(h^\infty).$$

Next, by (4.2.21) each backwards flow line of e^{tH_p} starting in $X_{2\delta_1}$ either stays forever in $X_{2\delta_1}$ or reaches the complement of $\text{WF}_h(\mathbf{u}(t))$ – see the proof of Proposition 4.2.4. By propagation of singularities for the equation (4.2.29), we find

$$\|A\mathbf{u}(t_1)\|_{L^2} \leq C\|\mathbf{u}(0)\|_{L^2(X_{\delta_1})} + \mathcal{O}(h^\infty), \quad A \in \Psi^{\text{comp}}(X_{2\delta_1}).$$

Also, for t_1 large enough, each flow line $\gamma(t)$, $t \in [-t_1, 0]$, of H_p such that $\gamma(0) \in X_{\delta_1}$ either satisfies $\gamma(-t_1) \in W'$ and $\gamma([-t_1, 0]) \subset X_{\delta_1}$, or there exists $s \in [-t_1, 0]$ such that $\gamma(s) \notin$

$\text{WF}_h(\mathbf{u}(t))$ for $t \in [t_1, T \log(1/h)]$ and $\gamma([s, 0]) \subset X_{\delta_1}$. This is true since if $\gamma(s) \in \text{WF}_h(\mathbf{u}(t))$, then $\gamma([s - t_1, s]) \subset X_{\delta_1}$, see the proof of Proposition 4.2.4. By propagation of singularities for (4.2.29), we get

$$\|\mathbf{u}(t)\|_{L^2(X_{\delta_1})} \leq C \|A_1 \mathbf{u}(t - t_1)\|_{L^2} + \mathcal{O}(h^\infty), \quad t \in [2t_1, T \log(1/h)]. \quad (4.2.55)$$

By (4.2.29) and (4.2.51), we have $(hD_t + P)(\tilde{\mathcal{S}}u_R(t)) = \mathcal{O}(h^\infty)$ on X_{δ_1} . Using propagation of singularities for this equation in a manner similar to (4.2.55), we obtain by (4.2.54)

$$\|\tilde{\mathcal{S}}u_R(t)\|_{L^2(X_{\delta_1})} \leq C \|A_1(1 - \Pi)\mathbf{u}(t - t_1)\|_{L^2} + \mathcal{O}(h^\infty), \quad t \in [2t_1, T \log(1/h)].$$

Combining these estimates with (4.2.39)–(4.2.43), we arrive to

$$\begin{aligned} \|\tilde{\mathcal{S}}u_\Pi(t_0)\|_{L^2(X_{\delta_1})} &\leq Ch^{-1/2} \|\mathbf{u}(0)\|_{L^2(X_{\delta_1})} + \mathcal{O}(h^\infty), \\ \|\tilde{\mathcal{S}}u_\Pi(t)\|_{L^2(X_{\delta_1})} &\leq Ce^{-(\nu_{\min} - \varepsilon)t/2} \|\tilde{\mathcal{S}}u_\Pi(t_0)\|_{L^2(X_{\delta_1})} + \mathcal{O}(h^\infty), \\ \|\tilde{\mathcal{S}}u_\Pi(t)\|_{L^2(X_{\delta_1})} &\geq C^{-1} e^{-(\nu_{\max} + \varepsilon)t/2} \|\tilde{\mathcal{S}}u_\Pi(t_0)\|_{L^2(X_{\delta_1})} - \mathcal{O}(h^\infty), \\ \|\tilde{\mathcal{S}}u_R(t)\|_{L^2(X_{\delta_1})} &\leq Ch^{-1} e^{-(\nu_{\min} - \varepsilon)t} \|\mathbf{u}(0)\|_{L^2(X_{\delta_1})} + \mathcal{O}(h^\infty), \\ \|\mathbf{u}(t)\|_{L^2(X_{\delta_1})} &\leq Ce^{\varepsilon t} \|\mathbf{u}(0)\|_{L^2(X_{\delta_1})} + \mathcal{O}(h^\infty), \end{aligned}$$

holding uniformly in $t \in [t_0 - 1, T \log(1/h)]$. To obtain (4.2.22)–(4.2.26) from here, we need to remove the operator $\tilde{\mathcal{S}}$ from the estimates; for that, we can use the fact that $\tilde{\mathcal{S}}$ is bounded uniformly in h on $L^2_{t,x}$ together with the equivalency of the norms $h\|\cdot\|_{L^\infty \mathcal{E}_x}$ and $\|\cdot\|_{L^2_{t,x}}$ for solutions of the wave equation (4.2.17) given by (4.2.19) and the functions of interest being microlocalized at frequencies $\sim h^{-1}$. \square

4.3 Applications to Kerr(–de Sitter) metrics

4.3.1 General properties

The Kerr(–de Sitter) metric in the Boyer–Lindquist coordinates is given by the formulas [20]

$$\begin{aligned} g = & -\rho^2 \left(\frac{dr^2}{\Delta_r} + \frac{d\theta^2}{\Delta_\theta} \right) - \frac{\Delta_\theta \sin^2 \theta}{(1 + \alpha)^2 \rho^2} (a dt - (r^2 + a^2) d\varphi)^2 \\ & + \frac{\Delta_r}{(1 + \alpha)^2 \rho^2} (dt - a \sin^2 \theta d\varphi)^2. \end{aligned}$$

Here $M > 0$ denotes the mass of the black hole, a its angular speed of rotation, and $\Lambda \geq 0$ is the cosmological constant (with $\Lambda = 0$ in the Kerr case and $\Lambda > 0$ in the Kerr–de Sitter case);

$$\begin{aligned} \Delta_r &= (r^2 + a^2) \left(1 - \frac{\Lambda r^2}{3} \right) - 2Mr, \quad \Delta_\theta = 1 + \alpha \cos^2 \theta, \\ \rho^2 &= r^2 + a^2 \cos^2 \theta, \quad \alpha = \frac{\Lambda a^2}{3}. \end{aligned}$$

The metric is originally defined on

$$\tilde{X}_0 := \mathbb{R}_t \times X_0, \quad X_0 := (r_-, r_+)_r \times \mathbb{S}^2,$$

here $\theta \in [0, \pi]$ and $\varphi \in \mathbb{S}^1 = \mathbb{R}/(2\pi\mathbb{Z})$ are the spherical coordinates on \mathbb{S}^2 . The numbers $r_- < r_+$ are the roots of Δ_r defined below; in particular, $\Delta_r > 0$ on (r_-, r_+) and $\pm\partial_r\Delta_r(r_\pm) < 0$. The metric becomes singular on the surfaces $\{r = r_\pm\}$, known as the *event horizons*; however, this can be fixed by a change of coordinates, see §4.3.4.

The Kerr(–de Sitter) family admits the scaling $M \mapsto sM, \Lambda \mapsto s^{-2}\Lambda, a \mapsto sa, r \mapsto sr, t \mapsto st$ for $s > 0$; therefore, we often consider the parameters a/M and ΛM^2 invariant under this scaling. We assume that $a/M, \Lambda M^2$ lie in a neighborhood of the Schwarzschild(–de Sitter) case (4.1.1) or the Kerr case (4.1.2). Then for $\Lambda > 0$, Δ_r is a degree 4 polynomial with real roots $r_1 < r_2 < r_- < r_+$, with $r_- > M$. For $\Lambda = 0$, Δ_r is a degree 2 polynomial with real roots $r_1 < M < r_-$; we put $r_+ = \infty$. The general set of Λ and a for which Δ_r has all real roots as above was studied numerically in [2, §3], and is pictured on Figure 4.1(a) in the introduction. Note that in [2], the roots are labeled $r_{--} < r_- < r_+ < r_C$; we do not adopt this (perhaps more standard) convention in favor of the notation of the previous chapters and [128], and since the roots r_1, r_2 are irrelevant in our analysis.

The symbol \tilde{p} defined in (4.2.2) using the dual metric is (denoting by τ the momentum corresponding to t)

$$\begin{aligned} \tilde{p} &= \rho^{-2}G, \quad G = G_r + G_\theta, \\ G_r &= \Delta_r \xi_r^2 - \frac{(1+\alpha)^2}{\Delta_r} ((r^2 + a^2)\tau + a\xi_\varphi)^2, \\ G_\theta &= \Delta_\theta \xi_\theta^2 + \frac{(1+\alpha)^2}{\Delta_\theta \sin^2 \theta} (a \sin^2 \theta \tau + \xi_\varphi)^2. \end{aligned}$$

Note that

$$\partial_{(t,\varphi,\theta,\xi_\theta)} G_r = 0, \quad \partial_{(t,\varphi,r,\xi_r)} G_\theta = 0, \quad (4.3.1)$$

therefore $\{G_r, G_\theta\} = 0$ and $G_\theta, \tau, \xi_\varphi$ are conserved quantities for the geodesic flow (4.2.3).

To handle the poles $\{\theta = 0\}$ and $\{\theta = \pi\}$, where the spherical coordinates (θ, φ) break down, introduce new coordinates (in a neighborhood of either of the poles)

$$x_1 = \sin \theta \cos \varphi, \quad x_2 = \sin \theta \sin \varphi; \quad (4.3.2)$$

note that $\sin^2 \theta = x_1^2 + x_2^2$ is a smooth function in this coordinate system. For the corresponding momenta ξ_1, ξ_2 , we have

$$\xi_\theta = (x_1 \xi_1 + x_2 \xi_2) \cot \theta, \quad \xi_\varphi = x_1 \xi_2 - x_2 \xi_1,$$

note that ξ_φ is a smooth function vanishing at the poles. Then G_r, G_θ are smooth functions near the poles, with

$$G_\theta = (1+\alpha)(\xi_1^2 + \xi_2^2) \quad \text{when } x_1 = x_2 = 0. \quad (4.3.3)$$

The vector field ∂_t is not timelike inside the ergoregion, described by the inequality

$$\Delta_r \leq a^2 \Delta_\theta \sin^2 \theta. \quad (4.3.4)$$

For $a \neq 0$, this region is always nonempty. However, the covector dt is always timelike:

$$G|_{\xi=dt} = (1 + \alpha)^2 \left(\frac{a^2 \sin^2 \theta}{\Delta_\theta} - \frac{(r^2 + a^2)^2}{\Delta_r} \right) < 0, \quad (4.3.5)$$

since $\Delta_r < r^2 + a^2$.

We now verify the geometric assumptions (1)–(4) of §4.2.2. Assumptions (1)–(3) have been established already; assumption (4) is proved by

Proposition 4.3.1. *Consider the function $\mu(r) \in C^\infty(r_-, r_+)$ defined by*

$$\mu(r) := \frac{\Delta_r(r)}{r^4}. \quad (4.3.6)$$

Then there exists $\delta_0 > 0$ such that for each $(\tilde{x}, \tilde{\xi}) \in T^* \tilde{X}_0$,

$$\mu(\tilde{x}) < \delta_0, \quad \tilde{\xi} \neq 0, \quad \tilde{p}(\tilde{x}, \tilde{\xi}) = 0, \quad H_{\tilde{p}}\mu(\tilde{x}, \tilde{\xi}) = 0 \implies H_{\tilde{p}}^2\mu(\tilde{x}, \tilde{\xi}) < 0. \quad (4.3.7)$$

Moreover, δ_0 can be chosen to depend continuously on M, Λ, a .

Proof. First of all, we calculate

$$\partial_r \mu(r) = -\frac{4\Delta_r - r\partial_r \Delta_r}{r^5}, \quad 4\Delta_r - r\partial_r \Delta_r = 2((1 - \alpha)r^2 - 3Mr + 2a^2), \quad (4.3.8)$$

therefore $\partial_r \mu(r) < 0$ for $\alpha \leq 1/2$ and $r > 6M$. Since $\partial_r \Delta_r(r_\pm) \neq 0$, we see that for δ_0 small enough and $\mu(r) < \delta_0$, we have $\partial_r \mu(r) \neq 0$. Therefore, we can replace the condition $H_{\tilde{p}}\mu = 0$ in (4.3.7) by $H_{\tilde{p}}r = 0$, which implies that $\xi_r = 0$; in this case, $H_{\tilde{p}}^2\mu$ has the same sign as $-\partial_r \mu \partial_r G_r$. We calculate for $\xi_r = 0$,

$$\begin{aligned} \partial_r G_r &= -\frac{(1 + \alpha)^2((r^2 + a^2)\tau + a\xi_\varphi)}{\Delta_r^2} \Psi(r), \\ \Psi(r) &:= 4r\tau\Delta_r - ((r^2 + a^2)\tau + a\xi_\varphi)\partial_r \Delta_r. \end{aligned} \quad (4.3.9)$$

Next, denote

$$A := (r^2 + a^2)\tau + a\xi_\varphi, \quad B := a\sin^2 \theta \tau + \xi_\varphi, \quad (4.3.10)$$

then

$$\rho^2 \tau = A - aB, \quad \Psi = \frac{(4r\Delta_r - \rho^2 \partial_r \Delta_r)A - 4ar\Delta_r B}{\rho^2}. \quad (4.3.11)$$

Using the equation $\tilde{p} = 0$, we get

$$\frac{A^2}{\Delta_r} \geq \frac{B^2}{\Delta_\theta \sin^2 \theta} \quad \text{on } \{\tilde{p} = \xi_r = 0\} \cap \{0 < \theta < \pi\}. \quad (4.3.12)$$

Since $\Delta_\theta \sin^2 \theta \leq 1$ everywhere for $\alpha \leq 1$, and $B = 0$ for $\sin \theta = 0$, we find

$$A^2 \geq \Delta_r B^2. \quad (4.3.13)$$

In particular, we see that $A \neq 0$, since otherwise $B = 0$, implying that $\tau = \xi_\varphi = 0$ and thus $\tilde{\xi} = 0$ since $\tilde{p} = \xi_r = 0$. Now, $H_{\tilde{p}}^2 \mu$ has the same sign as

$$\partial_r \mu ((4r\Delta_r - \rho^2 \partial_r \Delta_r) A^2 - 4ar\Delta_r AB). \quad (4.3.14)$$

We now calculate by (4.3.8) and since $\partial_r \Delta_r \leq 2r$, for $\alpha \leq 1/2$

$$\begin{aligned} 4r\Delta_r - \rho^2 \partial_r \Delta_r &= 2r((1-\alpha)r^2 - 3Mr + 2a^2) - a^2 \cos^2 \theta \partial_r \Delta_r \\ &\geq r(r^2 - 6Mr + 2a^2), \end{aligned}$$

and thus, since $\Delta_r \leq r^2 + a^2$ and $|a| < M$, and by (4.3.13),

$$\begin{aligned} (4r\Delta_r - \rho^2 \partial_r \Delta_r) A^2 - 4ar\Delta_r AB &\geq A^2 r(r^2 - 6Mr + 2a^2 - 4|a|\sqrt{\Delta_r}) \\ &\geq A^2 r(r^2 - 10Mr - 4M^2). \end{aligned}$$

We see that (4.3.7) holds for r large enough, namely $r > 14M$.

We now assume that $r \leq 14M$ and $\mu < \delta_0$. Then (here the constants do not depend on δ_0 and are locally uniform in M, Λ, a)

$$\Delta_r = \mathcal{O}(\delta_0), \quad |\partial_r \Delta_r| \geq C^{-1}, \quad \partial_r \mu = r^{-4} \partial_r \Delta_r + \mathcal{O}(\delta_0).$$

Then for δ_0 small enough, by (4.3.13) the expression (4.3.14) has the same sign as

$$A^2 \partial_r \Delta_r (-\rho^2 \partial_r \Delta_r + \mathcal{O}(\sqrt{\delta_0})) < 0,$$

as required. □

4.3.2 Structure of the trapped set

We now study the structure of trapping for Kerr(-de Sitter) metrics, summarized in the following

Proposition 4.3.2. *For $(\Lambda M^2, a/M)$ in a neighborhood of the union of (4.1.1) and (4.1.2), assumptions (5)–(8) of §4.2.2 are satisfied, with $\mu_{\max} = 0$ (see (4.2.11)) and the trapped set (see Definition 4.2.1) given by*

$$\tilde{K} = \{G = \xi_r = \partial_r G_r = 0, \tilde{\xi} \neq 0\} \subset T^* \tilde{X}_0 \setminus 0. \quad (4.3.15)$$

Remark. The assumptions on M, Λ, a can quite possibly be relaxed. The only parts of the proof that need us to be in a neighborhood of (4.1.1) or (4.1.2) are (4.3.17) and (4.3.18). Several other statements require that α is small (in particular, (4.3.26) requires $\alpha < \frac{\sqrt{2}-1}{\sqrt{2}+1}$), but this is true for the full admissible range of parameters depicted on Figure 4.1(a) in the introduction.

Remark. Some parts of Proposition 4.3.2 have previously been verified in [128, §6.4] in the case $|a| < \frac{\sqrt{3}}{2}M$.

We start by analysing the set \tilde{K} defined by (4.3.15); the fact that \tilde{K} is indeed the trapped set is established later, in Proposition 4.3.5. We first note that \tilde{K} is a closed conic subset of $\{\tilde{p} = 0\} \setminus 0$, invariant under the flow (4.2.3); indeed, $\xi_r = 0$ implies $H_{\tilde{p}}r = 0$, $\partial_r G_r = 0$ implies $H_{\tilde{p}}\xi_r = 0$, $H_{\tilde{p}}\tau = H_{\tilde{p}}\xi_\varphi = 0$ everywhere, and $\partial_r G_r$ depends only on $r, \xi_r, \tau, \xi_\varphi$.

By (4.3.9), and since $(r^2 + a^2)\tau + a\xi_\varphi = \tilde{p} = 0$ implies $\tilde{\xi} = 0$, we see that

$$\Psi = 0 \quad \text{on } \tilde{K}. \quad (4.3.16)$$

Assumption (5) in §4.2.2 follows from the inequality

$$\tau((r^2 + a^2)\tau + a\xi_\varphi) > 0 \quad \text{on } \tilde{K}. \quad (4.3.17)$$

For the Schwarzschild(–de Sitter) case (4.1.1), this is trivial (noting that $\tau = 0$ implies $\tilde{\xi} = 0$); for the Kerr case (4.1.2), it follows from (4.3.16) together with the fact that $\partial_r \Delta_r > 0$. The general case now follows by perturbation, using that, by Proposition 4.3.1, \tilde{K} is contained in a fixed compact subset of X_0 .

We next claim that

$$\partial_r^2 G < 0 \quad \text{on } \tilde{K}. \quad (4.3.18)$$

By (4.3.9), this is equivalent to requiring that $\tau \partial_r \Psi > 0$ on \tilde{K} . Now, in either of the cases (4.1.1) or (4.1.2), we calculate

$$\Psi(r) = 2(\tau r^3 - 3M\tau r^2 + a(a\tau - \xi_\varphi)r + Ma(a\tau + \xi_\varphi)). \quad (4.3.19)$$

In particular,

$$\Psi(M) = 4M\tau(a^2 - M^2), \quad \partial_r^2 \Psi(r) = 12\tau(r - M).$$

Since $|a| < M$, we see that

$$\tau\Psi(M) < 0; \quad \tau\partial_r^2 \Psi(r) > 0 \text{ for } r > M.$$

Therefore, if $r > r_- > M$ and $\Psi(r) = 0$, then $\tau\partial_r \Psi(r) > 0$ and we get (4.3.18) in the cases (4.1.1) and (4.1.2); the general case follows by perturbation, similarly to (4.3.17).

To study the behavior of \tilde{K} in the angular variables, we introduce the equatorial set

$$\tilde{K}_e := \tilde{K} \cap \{\theta = \pi/2, \xi_\theta = 0\}. \quad (4.3.20)$$

This is a closed conic subset of \tilde{K} invariant under the flow (4.2.3) (which is proved similarly to the invariance of \tilde{K}). We have

$$\partial_{\xi_\varphi} G \neq 0 \quad \text{on } \tilde{K}_e. \quad (4.3.21)$$

Indeed,

$$\partial_{\xi_\varphi} G = 2(1 + \alpha)^2 \left(-\frac{a((r^2 + a^2)\tau + a\xi_\varphi)}{\Delta_r} + a\tau + \xi_\varphi \right) \quad \text{on } \{\theta = \pi/2\}. \quad (4.3.22)$$

Also, the equation $G = 0$ implies

$$\frac{((r^2 + a^2)\tau + a\xi_\varphi)^2}{\Delta_r} = \frac{(a \sin^2 \theta \tau + \xi_\varphi)^2}{\Delta_\theta \sin^2 \theta} \quad \text{on } \tilde{K} \cap \{\xi_\theta = 0\}. \quad (4.3.23)$$

Putting $\theta = \pi/2$ into (4.3.23), we solve for Δ_r and substitute it into (4.3.22), obtaining

$$\partial_{\xi_\varphi} G = 2(1 + \alpha)^2 \frac{r^2 \tau (a\tau + \xi_\varphi)}{(r^2 + a^2)\tau + a\xi_\varphi} \neq 0 \quad \text{on } \tilde{K}_e, \quad (4.3.24)$$

implying (4.3.21).

At the poles $\{\theta = 0, \pi\}$, we have

$$|\partial_{\xi_1} G| + |\partial_{\xi_2} G| > 0. \quad (4.3.25)$$

This follows immediately from (4.3.3), as $\xi_1 = \xi_2 = 0$ would imply $G_\theta = 0$, which is impossible given that $\xi_r = 0$, $G = 0$, and $\tilde{\xi} \neq 0$.

Finally, we claim that

$$\tilde{K} \cap \{\xi_\theta = \partial_\theta G = 0\} \cap \{0 < \theta < \pi\} = \tilde{K}_e, \quad (4.3.26)$$

$$\partial_\theta^2 G > 0 \quad \text{on } \tilde{K}_e. \quad (4.3.27)$$

To see this, note that $0 < \Delta_r < r^2 + a^2$, $\Delta_\theta \geq 1$, and $(r^2 + a^2)\tau + a\xi_\varphi \neq 0$ by (4.3.17); we get from (4.3.23)

$$((r^2 + a^2)\tau + a\xi_\varphi)^2 < (r^2 + a^2) \frac{(a \sin^2 \theta \tau + \xi_\varphi)^2}{\sin^2 \theta} \quad \text{on } \tilde{K} \cap \{\xi_\theta = 0\},$$

or, using that $|a| < M < r$,

$$\frac{\xi_\varphi^2}{\sin^2 \theta} > (r^2 + a^2)\tau^2 > 2a^2\tau^2 \quad \text{on } \tilde{K} \cap \{\xi_\theta = 0\}. \quad (4.3.28)$$

Next, if $\xi_\theta = 0$, then

$$\partial_\theta G = \frac{2(1 + \alpha)^2 (a \sin^2 \theta \tau + \xi_\varphi) \cos \theta}{\Delta_\theta^2 \sin^3 \theta} ((1 + \alpha)a \sin^2 \theta \tau - (1 + \alpha \cos(2\theta))\xi_\varphi).$$

In particular, using (4.3.28) we obtain (4.3.27) for $\alpha = 0$:

$$\partial_\theta^2 G = 2(\xi_\varphi^2 - a^2\tau^2) > 0 \quad \text{on } \tilde{K}_e,$$

and the case of small α follows by perturbation. It remains to prove (4.3.26). Assume the contrary, that $\partial_\theta G = 0$, $\xi_\theta = 0$, but $\theta \neq \pi/2$. By (4.3.23), $a \sin^2 \theta \tau + \xi_\varphi \neq 0$; therefore, $(1 + \alpha)a \sin^2 \theta \tau = (1 + \alpha \cos(2\theta))\xi_\varphi$. Combining this with (4.3.28), we get $(1 + \alpha) \sin \theta > \sqrt{2}(1 + \alpha \cos(2\theta))$, which implies that $(1 + \alpha) > \sqrt{2}(1 - \alpha)$, a contradiction with the fact that α is small.

It follows from (4.3.18), (4.3.21), (4.3.25), and (4.3.26) that at each point of \tilde{K} the matrix of partial derivatives $G, \xi_r, \partial_r G$ in the variables $(r, \xi_r, *)$, where $*$ stands for one of $\theta, \xi_\theta, \xi_\varphi, \xi_1, \xi_2$, is invertible. This gives

Proposition 4.3.3. *The set \tilde{K} defined by (4.3.15) is a smooth codimension 2 submanifold of $\{\tilde{p} = 0\} \setminus 0$, and its projection \hat{K} onto the $\hat{x} = (t, \theta, \varphi), \hat{\xi} = (\tau, \xi_\theta, \xi_\varphi)$ variables is a smooth codimension 1 submanifold of $T^*(\mathbb{R} \times \mathbb{S}^2)$.*

We now study the global dynamics of the flow, relating it to the set \tilde{K} . Take $(\tilde{x}^0, \tilde{\xi}^0) \in \{\tilde{p} = 0\} \setminus 0$ and let $(\tilde{x}(t), \tilde{\xi}(t))$ be the corresponding Hamiltonian trajectory of (4.2.3). Consider the function

$$\Phi^0(r) = G_r(\tilde{x}^0, \tilde{\xi}^0) + (1 + \alpha)^2 \frac{((r^2 + a^2)\tau^0 + a\xi_\varphi^0)^2}{\Delta_r(r)}.$$

Note that $G_r(\tilde{x}(t), \tilde{\xi}(t)), \tau(t), \xi_\varphi(t)$ are constant in t and $(r(t), \xi_r(t))$ is a rescaled Hamiltonian flow trajectory of

$$H^0(r, \xi_r) := \Delta_r(r)\xi_r^2 - \Phi^0(r);$$

in particular, $(r(t), \xi_r(t))$ solve the equation

$$\Delta_r(r)\xi_r^2 = \Phi^0(r). \tag{4.3.29}$$

The key property of Φ^0 is given by

Proposition 4.3.4. *For each $r \in (r_-, r_+)$,*

$$\Phi^0(r) \geq 0, \quad \partial_r \Phi^0(r) = 0 \implies \partial_r^2 \Phi^0(r) > 0. \tag{4.3.30}$$

Proof. Assume that $\Phi^0(r) \geq 0$. Then we can find $(\tilde{x}^1, \tilde{\xi}^1) \in T^*\tilde{X}^0$ such that $(t^1, \theta^1, \varphi^1) = (t^0, \theta^0, \varphi^0)$, $\tilde{r}^1 = r$, $\tau^1 = \tau^0$, $\xi_\varphi^1 = \xi_\varphi^0$, $\xi_r^1 = 0$, and $\tilde{p}(\tilde{x}^1, \tilde{\xi}^1) = 0$; indeed, it suffices to start with $(\tilde{x}^0, \tilde{\xi}^0)$, put $r^1 = r$, $\xi_r^1 = 0$, and change the ξ_θ^1 component (or one of ξ_1^1, ξ_2^1 components if we are at the poles of the sphere) so that $G_\theta(\tilde{x}^1, \tilde{\xi}^1) = G_\theta(\tilde{x}^0, \tilde{\xi}^0) + \Phi^0(r)$. If additionally $\partial_r \Phi^0(r) = 0$, then $(\tilde{x}^1, \tilde{\xi}^1) \in \tilde{K}$; it remains to apply (4.3.18). \square

We now consider the following two cases:

Case 1: $|\Phi^0(r)| + |\partial_r \Phi^0(r)| > 0$ for all $r \in (r_-, r_+)$. In this case, the set of solutions to (4.3.29) is a closed one-dimensional submanifold of $T^*(r_-, r_+)$ and the Hamiltonian field of H^0 is nonvanishing on this manifold. This manifold has no compact connected components, as the function $\Phi^0(r)$ cannot achieve a local maximum on it by (4.3.30). It follows that the geodesic $(\tilde{x}(t), \tilde{\xi}(t))$ escapes in both time directions.

Case 2: there exists $r' \in (r_-, r_+)$ such that $\Phi^0(r') = \partial_r \Phi^0(r') = 0$. Then

$$(t^0, r', \theta^0, \varphi^0, \tau^0, 0, \xi_\theta^0, \xi_\varphi^0) \in \tilde{K},$$

therefore the projection $(\hat{x}^0, \hat{\xi}^0)$ lies in \hat{K} (see Proposition 4.3.3). By (4.3.30), we see that $\partial_r^2 \Phi^0(r') > 0$ and $(r - r')\partial_r \Phi^0(r) > 0$ for $r \neq r'$. Then the set of solutions to the equation (4.3.29) is equal to the union $\Gamma_+^0 \cup \Gamma_-^0$, where

$$\Gamma_\pm^0 = \{\xi_r = \mp \operatorname{sgn}(\tau^0) \operatorname{sgn}(r - r') \sqrt{\Phi^0(r)/\Delta_r(r)}\},$$

note that Γ_\pm^0 are smooth one-dimensional submanifolds of $T^*(r_-, r_+)$ intersecting transversely at $(r', 0)$. The trajectory $(\tilde{x}(t), \tilde{\xi}(t))$ is trapped as $t \rightarrow \mp\infty$ if and only if $(r^0, \xi_r^0) \in \Gamma_\pm^0$. Note that by (4.3.17), τ^0 is negative on \mathcal{C}_+ and positive on \mathcal{C}_- .

The analysis of the two cases above implies

Proposition 4.3.5. *The incoming/outgoing tails $\tilde{\Gamma}_\pm$ (see Definition 4.2.1) are given by (here \hat{K} is defined in Proposition 4.3.3)*

$$\tilde{\Gamma}_\pm := \{(r, \hat{x}, \xi_r, \hat{\xi}) \mid (\hat{x}, \hat{\xi}) \in \hat{K}, \xi_r = \mp \operatorname{sgn}(\hat{\tau}) \operatorname{sgn}(r - r'_{\hat{x}, \hat{\xi}}) \sqrt{\Phi_{\hat{x}, \hat{\xi}}(r)/\Delta_r(r)}\},$$

where

$$\Phi_{\hat{x}, \hat{\xi}}(r) = -G_\theta(\hat{x}, \hat{\xi}) + (1 + \alpha)^2 \frac{((r^2 + a^2)\hat{\tau} + a\hat{\xi}_\varphi)^2}{\Delta_r(r)},$$

and $r'_{\hat{x}, \hat{\xi}}$ is the only solution to the equation $\Phi_{\hat{x}, \hat{\xi}}(r) = 0$; moreover, $\partial_r \Phi_{\hat{x}, \hat{\xi}}(r'_{\hat{x}, \hat{\xi}}) = 0$ and $\partial_r^2 \Phi_{\hat{x}, \hat{\xi}}(r'_{\hat{x}, \hat{\xi}}) > 0$. Furthermore, $\tilde{\Gamma}_\pm$ are conic smooth codimension 1 submanifolds of $\{\tilde{p} = 0\} \setminus 0$ intersecting transversely, and their intersection is equal to the set \tilde{K} defined in (4.3.15).

We also see from (4.3.18) and the fact that $\partial_r \tilde{p} \neq 0$ on $\{\tilde{p} = 0\} \setminus 0$ (as follows from (4.3.5)) that the matrix of Poisson brackets of functions $G, \partial_r G, \xi_r, t$ on \tilde{K} is nondegenerate, which implies that the intersections $\tilde{K} \cap \{t = \text{const}\}$ are symplectic submanifolds of $T^* \tilde{X}_0$. Together with Proposition 4.3.5, this verifies assumptions (6) and (7) of §4.2.2.

It remains to verify r -normal hyperbolicity of the flow $\tilde{\varphi}^s$ defined in (4.2.3). We start by showing that the maximal expansion rate in the directions of the trapped set μ_{\max} , defined in (4.2.11), is equal to zero:

Proposition 4.3.6. *For each $\varepsilon > 0$, there exists a constant C such that for each $v \in T\tilde{K}$,*

$$|d\tilde{\varphi}^s v| \leq C e^{\varepsilon|s|} |v|.$$

Here $|\cdot|$ denotes any fixed smooth homogeneous norm on the fibers of $T\tilde{K}$.

Proof. Using the group property of the flow, it suffices to show that for each $\varepsilon > 0$ there exists $T > 0$ such that for each $v \in T\tilde{K}$,

$$|d\tilde{\varphi}^T v| < e^{\varepsilon T} |v|. \quad (4.3.31)$$

Since \tilde{K} is a closed conic set, and $\tilde{K} \cap \{\tau = 1\} \cap \{t = 0\}$ is compact, it suffices to show that for each flow line $\gamma(s)$ of (4.2.3) on \tilde{K} , there exists T such that (4.3.31) holds for each $v = v(0)$ tangent to \tilde{K} at $\gamma(0)$. Denote $v(s) = d\tilde{\varphi}^s v(0)$.

If $\gamma(s)$ is a trajectory of (4.2.3) on $T\tilde{K}$, then $r, \xi_r = 0, \tau$ are constant on $\gamma(s)$ and the generator of the flow does not depend on the variable t ; therefore, it suffices to show (4.3.31) for the restriction of the matrix of $d\tilde{\varphi}^T$ to the $\partial_\theta, \partial_\varphi, \partial_{\xi_\theta}, \partial_{\xi_\varphi}$ variables. This is equivalent to considering the Hamiltonian flow of G in the $\theta, \varphi, \xi_\theta, \xi_\varphi$ variables only, on $T^*\mathbb{S}^2$. Recall that the equatorial set $\tilde{K}_e = \tilde{K} \cap \{\theta = \pi/2, \xi_\theta = 0\}$ defined in (4.3.20) is invariant under $\tilde{\varphi}^s$. We then consider two cases:

Case 1: $\gamma(s) \notin \tilde{K}_e$ for all s . Then the differentials of G and ξ_φ are linearly independent by (4.3.25) and (4.3.26). Since $\{G, \xi_\varphi\} = 0$, by Arnold–Liouville theorem (see for example Proposition 2.3.8), there is a local symplectomorphism from a neighborhood of $\gamma(s)$ in $T^*\mathbb{S}^2$ to $T^*\mathbb{T}^2$, where \mathbb{T}^2 is the two-dimensional torus, which conjugates G to some function $f(\eta_1, \eta_2)$; here $(y_1, y_2, \eta_1, \eta_2)$ are the canonical coordinates on $T^*\mathbb{T}^2$. The corresponding evolution of tangent vectors is given by $\partial_s v_y(s) = \nabla^2 f(\eta(s)) v_\eta(s)$, $\partial_s v_\eta(s) = 0$, and (4.3.31) follows.

Case 2: $\gamma(s) \in \tilde{K}_e$ for all s . Since $\partial_s v_{\xi_\varphi}(s) = 0$ and $\partial_s v$ does not depend on $v_{\varphi(s)}$, it suffices to estimate $v_\theta(s), v_{\xi_\theta}(s)$. We then find

$$\partial_s v_\theta(s) = 2v_{\xi_\theta}(s), \quad \partial_s v_{\xi_\theta}(s) = -\partial_\theta^2 G(\gamma(s)) v_\theta(s) - \partial_{\theta\xi_\varphi}^2 G(\gamma(s)) v_{\xi_\varphi}(s).$$

Now, by (4.3.27), $\partial_\theta^2 G(\gamma(s))$ is a positive constant; (4.3.31) follows. \square

We finally show that the minimal expansion rate ν_{\min} , defined in (4.2.9), is positive. By Proposition 4.3.5, $(\tilde{x}, \tilde{\xi}) \in \tilde{\Gamma}_\pm$ if and only if

$$(\hat{x}, \hat{\xi}) \in \hat{K}, \quad \tilde{\varphi}_\pm(\tilde{x}, \tilde{\xi}) = 0,$$

where

$$\tilde{\varphi}_\pm(\tilde{x}, \tilde{\xi}) = \xi_r \mp \operatorname{sgn}(\partial_\tau G) \operatorname{sgn}(r - r'_{\hat{x}, \hat{\xi}}) \sqrt{\Phi_{\hat{x}, \hat{\xi}}(r) / \Delta_r(r)}.$$

Since H_G is tangent to $\tilde{\Gamma}_\pm$, we have $H_G \tilde{\varphi}_\pm = 0$ on $\tilde{\Gamma}_\pm$; it follows that

$$\frac{H_G \tilde{\varphi}_\pm(\tilde{x}, \tilde{\xi})}{\partial_\tau G} = \mp \tilde{\nu}_\pm(\tilde{x}, \tilde{\xi}) \tilde{\varphi}_\pm(\tilde{x}, \tilde{\xi}) \quad \text{when } (\hat{x}, \hat{\xi}) \in \hat{K}, \quad (4.3.32)$$

for some functions \tilde{v}_\pm . By calculating $\partial_{\xi_r} H_G \tilde{\varphi}_\pm|_{\tilde{K}}$, we find $\tilde{v}_+|_{\tilde{K}} = \tilde{v}_-|_{\tilde{K}} = \tilde{v}$, where

$$\tilde{v} = \frac{\sqrt{-2\Delta_r \partial_r^2 G_r}}{|\partial_\tau G|}; \quad (4.3.33)$$

note that $\partial_r^2 G_r < 0$ on \tilde{K} by (4.3.18) and $\partial_\tau G \neq 0$ on $\{\tilde{p} = 0\} \setminus 0$ by assumption (3) in §4.2.2.

Let $\tilde{\mathcal{V}}_\pm$ be the one-dimensional subbundles of $T\tilde{\Gamma}_\pm$ defined in (4.2.7), invariant under the flow $\tilde{\varphi}^s$. Since $d\tilde{\varphi}_\mp$ vanishes on $T\tilde{K}$ and is not identically zero on $T_{\tilde{K}}\tilde{\Gamma}_\pm$, we can fix a basis v_\pm of $\tilde{\mathcal{V}}_\pm|_{\tilde{K}}$ by requiring that

$$d\tilde{\varphi}_\mp \cdot v_\pm = 1.$$

Denote by $V = H_G/\partial_\tau G$ the generator of the flow $\tilde{\varphi}^s$. The Lie derivative $\mathcal{L}_V v_\pm$ is a multiple of v_\pm ; to compute it, we use the identity

$$0 = V(d\tilde{\varphi}_\mp \cdot v_\pm) = \mathcal{L}_V(d\tilde{\varphi}_\mp) \cdot v_\pm + d\tilde{\varphi}_\mp \cdot \mathcal{L}_V v_\pm.$$

Since (4.3.32) holds on $\tilde{\Gamma}_+ \cup \tilde{\Gamma}_-$, we get on vectors tangent to $\tilde{\Gamma}_\pm$,

$$\mathcal{L}_V(d\tilde{\varphi}_\mp) = d(\pm\tilde{v}_\mp \tilde{\varphi}_\mp) = \pm\tilde{v} d\tilde{\varphi}_\mp \quad \text{on } \tilde{K}.$$

It follows that

$$\partial_s(d\tilde{\varphi}^s v_\pm) = \pm(\tilde{v} \circ \tilde{\varphi}^s) v_\pm,$$

which implies immediately

Proposition 4.3.7. *The expansion rates defined in (4.2.9) and (4.2.10) are given by*

$$\nu_{\min} = \liminf_{T \rightarrow \infty} \inf_{(x, \xi) \in K} \langle \nu \rangle_T, \quad \nu_{\max} = \limsup_{T \rightarrow \infty} \sup_{(x, \xi) \in K} \langle \nu \rangle_T,$$

where $\tilde{v} > 0$ is the function on \tilde{K} defined in (4.3.33) and

$$\langle \tilde{v} \rangle_T := \frac{1}{T} \int_0^T \tilde{v} \circ \tilde{\varphi}^s ds.$$

Together, Proposition 4.3.6 and 4.3.7 verify assumption (8) of §4.2.2 and finish the proof of Proposition 4.3.2.

4.3.3 Trapping in special cases

We now establish some properties of the trapped set \tilde{K} and the local expansion rate \tilde{v} , defined in (4.3.33), in two special cases. We start with the Schwarzschild(–de Sitter) case (4.1.1), when everything can be described explicitly:

Proposition 4.3.8. *For $a = 0$, we have*

$$\tilde{K} = \left\{ \xi_r = 0, r = 3M, \tau \neq 0, G_\theta = \frac{27M^2}{1 - 9\Lambda M^2} \tau^2 \right\}, \quad (4.3.34)$$

$$\tilde{\nu} = \frac{\sqrt{1 - 9\Lambda M^2}}{3\sqrt{3}M}. \quad (4.3.35)$$

Proof. We recall from (4.3.16) that \tilde{K} is given by the equations $G = 0, \xi_r = 0, \Psi = 0$, where Ψ is computed using (4.3.19):

$$\Psi(r) = 2\tau r^2(r - 3M).$$

Since $\tau \neq 0$ on \tilde{K} by (4.3.17), we see that $\Psi = 0$ is equivalent to $r = 3M$. Now, $\Delta_r(3M) = 3M^2(1 - 9\Lambda M^2)$; therefore, $G_r = -\frac{27M^2}{(1 - 9\Lambda M^2)}\tau^2$ for $\xi_r = 0$ and $r = 3M$ and we obtain (4.3.34). Next, by (4.3.9), we find

$$\partial_r^2 G_r = -\frac{r^2 \tau}{\Delta_r^2} \partial_r \Psi(r) = -\frac{18}{(1 - 9\Lambda M^2)^2} \tau^2 \quad \text{on } \tilde{K}.$$

Finally, we compute

$$\partial_\tau G = -\frac{54M^2}{1 - 9\Lambda M^2} \tau \quad \text{on } \tilde{K},$$

and (4.3.35) follows. \square

We next consider the case when $\Lambda = 0$ and a approaches the maximal rotation speed M from below, calculating the expansion rates on two equators to show that the pinching condition (4.1.12) is violated:

Proposition 4.3.9. *Fix M and assume that*

$$\Lambda = 0, \quad a = M - \epsilon, \quad 0 < \epsilon \ll 1.$$

Then \tilde{K}_ϵ , defined in (4.3.20), is the union of two conical sets

$$E_\pm = \{r = R_\pm(\epsilon), \xi_r = 0, \xi_\varphi = F_\pm(\epsilon)\tau, \theta = \pi/2, \xi_\theta = 0, \tau \neq 0\},$$

where $R_+(\epsilon), F_+(\epsilon)$ are smooth functions of ϵ , $R_-(\epsilon), F_-(\epsilon)$ are smooth functions of $\sqrt{\epsilon}$, and (see Figure 4.4)

$$\begin{aligned} R_+(\epsilon) &= 4M + \mathcal{O}(\epsilon), & F_+(\epsilon) &= 7M + \mathcal{O}(\epsilon); \\ R_-(\epsilon) &= M + \sqrt{8\epsilon M/3} + \mathcal{O}(\epsilon), & F_-(\epsilon) &= -2M - \sqrt{6\epsilon M} + \mathcal{O}(\epsilon). \end{aligned} \quad (4.3.36)$$

Finally, the expansion rates $\tilde{\nu}$ defined in (4.3.33) are given by (see also Figure 4.2(a) in the introduction)

$$\tilde{\nu} = \frac{3\sqrt{3}}{28M} + \mathcal{O}(\epsilon) \quad \text{on } E_+; \quad \tilde{\nu} = \frac{\sqrt{\epsilon/2M}}{M} + \mathcal{O}(\epsilon) \quad \text{on } E_-. \quad (4.3.37)$$

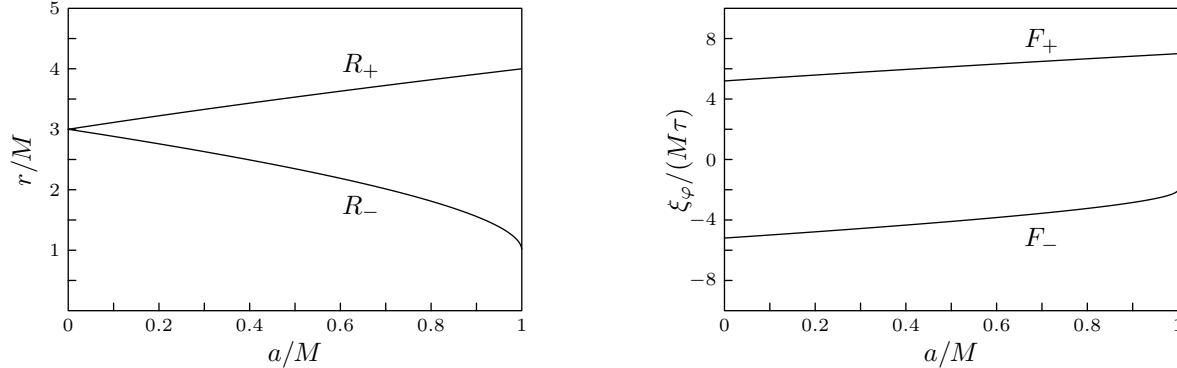

Figure 4.4: The graphs of r and ξ_φ/τ on the trapped equators E_\pm , as functions of a for $\Lambda = 0$.

Proof. The set \tilde{K}_ϵ is defined by equations $\xi_r = \xi_\theta = 0$, $\theta = \pi/2$, and (see (4.3.16))

$$\begin{aligned} ((r^2 + a^2)\tau + a\xi_\varphi)^2 &= \Delta_r(r)(a\tau + \xi_\varphi)^2, \\ 4r\tau\Delta_r(r) &= ((r^2 + a^2)\tau + a\xi_\varphi)\partial_r\Delta_r(r). \end{aligned} \quad (4.3.38)$$

Recall that $\Delta_r(r) = r^2 + a^2 - 2Mr$. Putting $A = (r^2 + a^2)\tau + a\xi_\varphi$ and $B = a\tau + \xi_\varphi$, we rewrite these as

$$\begin{aligned} A^2 &= \Delta_r(r)B^2, \\ 4(A - aB)\Delta_r(r) &= Ar\partial_r\Delta_r(r). \end{aligned}$$

The second equation can be written as $(r^2 + 2a^2 - 3Mr)A = 2a\Delta_r(r)B$. Solving for B and substituting into the first equation, we get

$$4a^2\Delta_r(r) - (r^2 + 2a^2 - 3Mr)^2 = 0. \quad (4.3.39)$$

This is a fourth order polynomial equation in r with coefficients depending on ϵ and with a root at $r = 0$; we will study the behavior of the other three roots as $\epsilon \rightarrow 0$. We write (4.3.39) as

$$(r - M)^2(r - 4M) = -8\epsilon M^2 + \mathcal{O}(\epsilon^2). \quad (4.3.40)$$

By the implicit function theorem, for ϵ small enough, the equation (4.3.39) has a solution $R = R_+(\epsilon) = 4M + \mathcal{O}(\epsilon)$. We next identify the two roots lying near $r = M$; they are solutions to the equations

$$r - M = \pm M \sqrt{\frac{8 + \mathcal{O}(\epsilon)}{4M - r}} \cdot \sqrt{\epsilon}.$$

The solution with the negative sign lies to the left of $r_- > M$, therefore we ignore it. The solution with the positive sign, which we denote by $R_-(\epsilon)$, exists for ϵ small enough by the implicit function theorem and we find $R_-(\epsilon) = M + \sqrt{8\epsilon M/3} + \mathcal{O}(\epsilon)$.

To find the values of ξ_φ/τ corresponding to $r = R_\pm(\epsilon)$, we use the second equation in (4.3.38); this completes the proof of (4.3.36). Finally, we calculate at $r = R_+(\epsilon)$, $\xi_\varphi = F_+(\epsilon)\tau$,

$$\Delta_r = 9M^2 + \mathcal{O}(\epsilon), \quad \partial_r^2 G = -\frac{32}{3}\tau^2 + \mathcal{O}(\epsilon), \quad \partial_\tau G = -\frac{224}{3}M^2\tau + \mathcal{O}(\epsilon),$$

and at $r = R_-(\epsilon)$, $\xi_\varphi = F_-(\epsilon)\tau$,

$$\Delta_r = \frac{2M}{3}\epsilon + \mathcal{O}(\epsilon^2), \quad \partial_r^2 G = -\frac{9M}{\epsilon}\tau^2 + \mathcal{O}(\epsilon^{-1/2}), \quad \partial_\tau G = -2\sqrt{\frac{6M}{\epsilon}}M^2\tau + \mathcal{O}(1);$$

(4.3.37) follows. □

4.3.4 Results for linear waves

In this section, we apply Theorem 4.4 in §4.2.4 and the analysis of §§4.3.1, 4.3.2 to obtain Theorems 4.1 and 4.2.

We start by formulating a well-posed problem for the wave equation on the Kerr–de Sitter background. For that, we in particular need to shift the time variable, see §§1.2, 2.2.1. Let μ be the defining function of the event horizons and/or spatial infinity defined in (4.3.6) and fix a small constant δ_1 , used in Theorem 4.4 as well as in (4.2.13). To continue the metric smoothly past the event horizons, we make the change of variables

$$t = t^* + F_t(r), \quad \varphi = \varphi^* + F_\varphi(r), \tag{4.3.41}$$

where F_t, F_φ are smooth real-valued functions on (r_-, r_+) such that

- $F'_t(r) = \pm \frac{1+\alpha}{\Delta_r(r)}(r^2 + a^2) + f_\pm(r)$ and $F'_\varphi(r) = \pm \frac{1+\alpha}{\Delta_r(r)}a$ near $r = r_\pm$, where f_\pm are smooth functions (for the Kerr case $\Lambda = 0$, we only require this at $r = r_-$)
- $F_t(r) = F_\varphi(r) = 0$ near $\{\mu \geq \delta_1/10\}$ (and also for r large enough in the Kerr case $\Lambda = 0$);
- the covector dt^* is timelike everywhere; equivalently, the level surfaces of t^* are spacelike.

See for example [128, §6.1 and (6.15)] for how to construct such F_t, F_φ . The metric in the coordinates $(t^*, r, \theta, \varphi^*)$ continues smoothly through $\{r = r_-\}$ and $\{r = r_+\}$ (the latter for $\Lambda > 0$), to an extension $\tilde{X}_{-\delta_1} := \{\mu > -\delta_1\}$ of \tilde{X}_0 past the event horizons. Since $F_t = F_\varphi = 0$ near $\{\mu \geq \delta_1/10\}$, our change of variables does not affect the arguments in §4.2.

The principal symbol of $h^2\Box_{\tilde{g}}$ in the new variables, denoted by \tilde{p}^* , is given by

$$\tilde{p}^*(r, \theta, \tau^*, \xi_r, \xi_\theta, \xi_{\varphi^*}) = \tilde{p}(r, \theta, \tau^*, \xi_r - \partial_r F_t(r)\tau^* - \partial_r F_\varphi(r)\xi_{\varphi^*}, \xi_\theta, \xi_{\varphi^*}).$$

In particular, if $\xi_\theta = \xi_{\varphi^*} = 0$, then for r close to r_- or to r_+ (the latter case for $\Lambda > 0$),

$$\tilde{p}^* = \Delta_r(\xi_r - f_\pm(r)\tau^*)^2 \mp 2(1 + \alpha)(r^2 + a^2)\tau^*(\xi_r - f_\pm(r)\tau^*) + \frac{(1 + \alpha)^2 a^2 \sin^2 \theta}{\Delta_\theta} (\tau^*)^2.$$

Then in the new coordinates,

$$\tilde{g}^{-1}(dr, dr) = -\Delta_r, \quad \tilde{g}^{-1}(dr, dt^*) = \pm(1 + \alpha)(r^2 + a^2) + \Delta_r f_\pm(r). \quad (4.3.42)$$

Therefore, the surfaces $\{r = r_0\}$ are timelike for $\mu(r_0) > 0$, lightlike for $\mu(r_0) = 0$, and spacelike for $\mu(r_0) < 0$, and $\tilde{g}^{-1}(d\mu, dt^*) < 0$ near the event horizon(s). Moreover, for $\Lambda = 0$ the d'Alembert–Beltrami operator

$$\begin{aligned} \square_{\tilde{g}} &= \frac{1}{\rho^2} D_r (\Delta_r D_r) + \frac{1}{\rho^2 \sin \theta} D_\theta (\sin \theta D_\theta) \\ &+ \frac{(a \sin^2 \theta D_t + D_\varphi)^2}{\rho^2 \sin^2 \theta} - \frac{((r^2 + a^2) D_t + a D_\varphi)^2}{\rho^2 \Delta_r} \end{aligned}$$

belongs to Melrose's scattering calculus on the space slices near $r = \infty$ (see [129, §2]) in the sense that it is a polynomial in the differential operators $D_t, D_r, r^{-1}D_\theta, r^{-1}D_\varphi$ with coefficients smooth up to $\{r^{-1} = 0\}$ in the r^{-1}, θ, φ variables (where of course θ, φ are replaced by a different coordinate system on \mathbb{S}^2 near the poles $\{\sin \theta = 0\}$).

Consider the initial-value problem for the wave equation (here $s \geq 0$ is integer)

$$\begin{aligned} \square_{\tilde{g}} u &= 0, \quad t^* \geq 0; \quad u|_{t^*=0} = f_0, \quad \partial_{t^*} u|_{t^*=0} = f_1; \\ f_0 &\in H^{s+1}(X_{-\delta_1}), \quad f_1 \in H^s(X_{-\delta_1}). \end{aligned} \quad (4.3.43)$$

This problem is well-posed, based on standard methods for hyperbolic equations [123, §6.5] and the following crude energy estimate: if we consider functions on $\tilde{X}_{-\delta_1}$ as functions of t^* with values in functions on $X_{-\delta_1}$, then for $t' \geq 0$,

$$\begin{aligned} &\|u(t')\|_{H^{s+1}(X_{-\delta_1})} + \|\partial_{t^*} u(t')\|_{H^s(X_{-\delta_1})} \\ &\leq C e^{Ct'} (\|u(0)\|_{H^{s+1}(X_{-\delta_1})} + \|\partial_{t^*} u(0)\|_{H^s(X_{-\delta_1})} + \|e^{-Ct^*} \square_{\tilde{g}} u\|_{H^s((0,t') \times X_{-\delta_1})}). \end{aligned} \quad (4.3.44)$$

To prove (4.3.44) for $s = 0$, we use the standard energy estimate on $\Omega = \tilde{X}_{-\delta_1} \cap \{0 \leq t^* \leq t'\}$ for hyperbolic equations (see [123, §2.8], Proposition 1.2.1, or [46, §1.1]), with the timelike vector field \mathcal{N} equal to ∂_t (a Killing field) for large r (in the case $\Lambda = 0$) and to $\tilde{g}^{-1}(dt^*)$ close to the event horizon(s); by (4.3.42), the boundary $\partial\Omega$ is spacelike and \mathcal{N} points inside of Ω on $\{t^* = 0\}$ and outside of it elsewhere on $\partial\Omega$. The higher order estimates are obtained from here as in [123, (6.5.14)], commuting with differential operators in the scattering calculus.

We now assume that $f_0 = f_0(h), f_1 = f_1(h)$ are such that $\|f_0\|_{H^1(X_{-\delta_1})} + \|f_1\|_{L^2(X_{-\delta_1})}$ is bounded polynomially in h and f_0, f_1 are localized at frequencies $\sim h^{-1}$, namely (see the discussion in §4.2.1)

$$\text{WF}_h(f_0) \cup \text{WF}_h(f_1) \subset T^*X_{-\delta_1} \setminus 0.$$

Let u be the corresponding solution to (4.3.43) and assume that it is extended to small negative times (which can be done by taking a smaller δ_1 and using the local existence result backwards in time). By (4.3.44), we see that u is h -tempered uniformly for $t^* \in [0, T \log(1/h)]$. Similarly to (4.2.18), $\widetilde{\text{WF}}_h(u) \subset \{\tilde{p}^* = 0\}$. Moreover, using standard microlocal analysis for hyperbolic equations, we get a pseudodifferential one-to-one correspondence between (f_0, f_1) and $(u_+(0), u_-(0))$, where u_\pm are the components of u microlocalized on \mathcal{C}_\pm , the positive and negative parts of the light cone, each solving an equation of the form $(hD_t + P_\pm)u_\pm = \mathcal{O}(h^\infty)$ for some spatial pseudodifferential operators P_\pm (similarly to (4.2.28)). This gives

$$\text{WF}_h(u) \cap \{t^* = 0\} \subset \{(0, x, \tau, \xi) \mid \tilde{p}^*(x, \tau, \xi) = 0, (x, \xi) \in \text{WF}_h(f_0) \cup \text{WF}_h(f_1)\}.$$

In particular, we get

$$\text{WF}_h(u) \cap \{t^* = 0\} \subset T^*\tilde{X}_{-\delta_1} \setminus 0. \quad (4.3.45)$$

By the same correspondence, if $\text{WF}_h(u) \cap \{t^* = 0\}$ is compact and covered by finitely many open subsets of $T^*\tilde{X}_{-\delta_1} \setminus 0$, then we can apply the associated pseudodifferential partition of unity to f_0, f_1 to split u into several solutions to the wave equation such that the wavefront set of each solution at $t^* = 0$ is contained in one of the covering sets. The resulting solutions can then each be analysed separately.

We next assume that

$$\text{supp } f_0 \cup \text{supp } f_1 \subset X_{\delta_1}.$$

We obtain some restrictions on the microlocalization of u for large times. For that, we need to consider the dynamics of the geodesic flow on the extended spacetime \tilde{X}_{δ_1} . Define the flow $\hat{\varphi}^s$ similarly to (4.2.3), rescaling the geodesic flow so that the variable t^* is growing with speed 1. Since $t = t^*, \varphi = \hat{\varphi}^*$ on $\tilde{X}_{\delta_1/10}$, the flow lines of $\tilde{\varphi}^s$ and $\hat{\varphi}^s$ coincide on $\tilde{X}_{\delta_1/10}$. If $\gamma(s)$ is a flow line of $\hat{\varphi}^s$ such that $\gamma(0) \in \tilde{X}_{\delta_1/10}$ and γ is not trapped for positive times according to Definition 4.2.1, then either $\gamma(s)$ escapes to the Euclidean infinity (for $\Lambda = 0$) or $\gamma(s)$ crosses one of the event horizons at some fixed positive time s_0 , and $\mu(\gamma(s)) < 0$ is strictly decreasing for $s > s_0$ (see the discussion following [128, (6.22)], verifying [128, (2.8)]); in the latter case, we say that γ escapes through the event horizons.

The next statement makes nontrivial use of the structure of the infinite ends (in particular, using [89, 129, 35] for the asymptotically Euclidean end for $\Lambda = 0$) and is the key step for obtaining control on the escaping parts of the solution for long times:

Proposition 4.3.10. *Assume that all flow lines of $\hat{\varphi}^s$ starting on $\text{WF}_h(u) \cap \{t^* = 0\}$ escape, either to the spatial infinity or through the event horizons. Then there exists $T_0 > 0$ such that uniformly in t^* ,*

$$\|u(t^*)\|_{H^1(X_{\delta_1})} + \|\partial_{t^*} u(t^*)\|_{L^2(X_{\delta_1})} = \mathcal{O}(h^\infty), \quad t^* \in [T_0, T \log(1/h)]. \quad (4.3.46)$$

Proof. We first consider the case when $\text{WF}_h(u) \cap \{t^* = 0\}$ is contained in a small neighborhood of some $(\tilde{x}, \tilde{\xi}) \in T^*X_{\delta_1} \setminus 0$, and, for $\gamma(s) = \hat{\varphi}^s(\tilde{x}, \tilde{\xi})$, there exists $T_0 > 0$ such that $\gamma([0, T_0]) \subset \tilde{X}_{-3\delta_1/4}$ and $\gamma(T_0) \in \{\mu < -\delta_1/2\}$. By propagation of singularities for the wave

equation (see for example Proposition 3.3.4), we see that $\text{WF}_h(u) \cap \{t^* = T_0\} \subset \{\mu < -\delta_1/2\}$; it follows that

$$\|u(T_0)\|_{H^1(X_{-\delta_1/2})} + \|\partial_{t^*} u(T_0)\|_{L^2(X_{-\delta_1/2})} = \mathcal{O}(h^\infty).$$

Then the same bound holds for $t^* \geq T_0$ in place of T_0 by (4.3.44) (replacing δ_1 by $\delta_1/2$).

For the remainder of this proof, we consider the opposite case, when $\Lambda = 0$ and each flow line of $\hat{\varphi}^s$ starting on $\text{WF}_h(u) \cap \{t^* = 0\}$ escapes to the spatial infinity. Fix a large constant R_1 ; we require in particular that $X_{\delta_1} \subset \{r < R_1\}$. By propagation of singularities, similarly to the previous paragraph, we may shift the time parameter and assume that $\text{WF}_h(u) \cap \{t^* = 0\}$ is contained in a small neighborhood of some $(\tilde{x}_0, \tilde{\xi}_0) \in T^*\tilde{X}_0 \setminus 0$, where $r_0 > R_1$, $\partial_s \mu(\hat{\varphi}^s(\tilde{x}_0, \tilde{\xi}_0))|_{s=0} < 0$. In fact, by (4.3.44) and finite speed of propagation, we may assume that for t^* near 0, the support of u in x is contained in a compact subset of $\{r > R_1\}$. Without loss of generality, we assume that $\tau_0 < 0$. The trajectory $\hat{\varphi}^s(\tilde{x}_0, \tilde{\xi}_0)$ does not intersect $\{r \leq R_1\}$ for $s \geq 0$.

We replace the Kerr spacetime (\tilde{X}_0, \tilde{g}) with a different spacetime $(\mathbb{R}_t \times \mathbb{R}_{r,\theta,\varphi}^3, \tilde{g}_1)$, where (r, θ, φ) are the spherical coordinates on \mathbb{R}^3 and \tilde{g}_1 is the stationary Lorentzian metric defined on \mathbb{R}^4 by

$$\tilde{g}_1^{-1} := \chi_1(r)\tilde{g}_0^{-1} + (1 - \chi_1(r))\tilde{g}^{-1},$$

where $\tilde{g}_0^{-1} = \tau^2 - \xi_r^2 - \xi_\theta^2/r^2 - \xi_\varphi^2/(r^2 \sin^2 \theta)$ is the Minkowski metric on \mathbb{R}^4 , $\chi_1 \in C_0^\infty([0, R_1])$, $0 \leq \chi_1 \leq 1$ everywhere, and $\chi_1 = 1$ on $[0, R_1/2]$. The dual metrics \tilde{g}^{-1} and \tilde{g}_0^{-1} are close to each other for large r in the sense of scattering metrics, that is, as quadratic forms in $\tau, \xi_r, r^{-1}\xi_\theta, r^{-1}\xi_\varphi$, therefore for R_1 large enough, \tilde{g}_1^{-1} is the dual to a Lorentzian metric, the surfaces $\{t = \text{const}\}$ are spacelike, and ∂_t is a timelike vector field. Note that the new spacetime no longer contains an event horizon.

We now show that \tilde{g}_1^{-1} is nontrapping for large R_1 and a correct choice of χ_1 , that is, each lightlike geodesic escapes to the spatial infinity in both time directions. It suffices to prove that if $\tilde{p}_1(\tilde{x}, \tilde{\xi}) = -\tilde{g}_{1,\tilde{x}}^{-1}(\tilde{\xi}, \tilde{\xi})$, then (compare with assumption (4) in §4.2.2)

$$r > 0, \tilde{p}_1 = 0, \tilde{\xi} \neq 0, H_{\tilde{p}_1} r(\tilde{x}, \tilde{\xi}) = 0 \implies H_{\tilde{p}_1}^2 r(\tilde{x}, \tilde{\xi}) > 0.$$

Indeed,

$$H_{\tilde{p}_1} r = 2\xi_r(\chi_1(r) + (1 - \chi_1(r))\Delta_r/\rho^2);$$

therefore, $H_{\tilde{p}_1} r = 0$ implies $\xi_r = 0$ and $H_{\tilde{p}_1}^2 r$ has the same sign as

$$-\partial_r \tilde{p}_1 = -\chi_1'(r)(\tilde{p}_0 - \tilde{p}) - \chi_1(r)\partial_r \tilde{p}_0 - (1 - \chi_1(r))\partial_r \tilde{p};$$

it remains to note that we can take $r\chi_1'(r)$ bounded by 3, $\tilde{p}_0 - \tilde{p}$ is small for large r in the sense of scattering metrics, and both $r\partial_r \tilde{p}_0$ and $r\partial_r \tilde{p}$ are homogeneous of degree 2 in $\tilde{\xi}$ and bounded from above by a negative constant on $\{\tau^2 + r^{-2}\xi_\theta^2 + r^{-2}\xi_\varphi^2 = 1\} \cap \{\tilde{p}_1 = \xi_r = 0\}$, uniformly in $r^{-1} \geq 0$ for $\partial_r \tilde{p}_0$ and uniformly in $r^{-1} \in [0, \delta_1)$ for $\partial_r \tilde{p}$.

Let u_1 be the solution to the wave equation on the new spacetime $(\mathbb{R}^4, \tilde{g}_1)$ such that $u_1|_{t=0} = u|_{t^*=0}$, $\partial_t u_1|_{t=0} = \partial_{t^*} u|_{t^*=0}$. It is enough to prove that, with $\widetilde{\text{WF}}_h(u_1)$ defined

in §4.2.1,

$$\widetilde{\text{WF}}_h(u_1) \cap \{r < R_1\} = \emptyset, \quad 0 \leq t \leq T \log(1/h). \quad (4.3.47)$$

Indeed, in this case $\square_{\hat{g}}((1 - \chi_1(r))u_1) = \mathcal{O}(h^\infty)_{C^\infty}$; by (4.3.44), we have $\widetilde{\text{WF}}_h(u_1) = \widetilde{\text{WF}}_h(u)$ for $t \in [0, T \log(1/h)]$, and (4.3.46) follows since $X_{\delta_1} \subset \{r < R_1\}$.

To show (4.3.47), we use the Fourier transform in time,

$$\hat{u}_1(\lambda) = \int_{\mathbb{R}} e^{i\lambda t} \psi_1(t) u_1(t) dt, \quad \text{Im } \lambda > 0.$$

Here $\psi_1(t)$ is supported in $[-\delta, \infty)$ and is equal to 1 on $[\delta, \infty)$, for some small fixed $\delta > 0$. The integral converges, as $\|u_1(t)\|_{H^2(\mathbb{R}^3)} \leq C e^{\varepsilon t}$ for each $\varepsilon > 0$, as follows from the standard energy estimate for the wave equation (see the paragraph following (4.3.44)) applied for the timelike Killing vector field ∂_t .

Let $\hat{P}(\lambda)$ be the stationary d'Alembert–Beltrami operator for the metric \hat{g} , constructed by replacing D_t by $-\lambda$ in the operator $\square_{\hat{g}}$; the semiclassical version defined in §4.2.3 is given by the relation $\hat{P}_h(\omega) = h^2 \hat{P}(h^{-1}\omega)$. Then

$$\hat{P}(\lambda) \hat{u}_1(\lambda) = \hat{f}_1(\lambda), \quad \text{Im } \lambda > 0,$$

where $f_1 = [\square_{\hat{g}}, \psi_1(t)]u_1(t)$. We note that $\text{WF}_h(f_1)$ is contained in a small neighborhood of $(\tilde{x}_0, \tilde{\xi}_0)$ and f_1 is compactly supported; therefore, $\hat{f}_1(h^{-1}\omega + iE) = \mathcal{O}(h^\infty)_{\mathcal{S}_\omega C_0^\infty(\mathbb{R}^3)}$ for ω outside of a small neighborhood of $-\tau_0 > 0$, and $\text{WF}_h(\hat{f}_1(h^{-1}\omega + iE))$ lies in a small neighborhood of (x_0, ξ_0) for all ω .

We now apply the results of [89, 129, 35]. For this, note that for any fixed λ , the operator $\hat{P}(\lambda)$ lies in Melrose's scattering calculus on the radially compactified \mathbb{R}^3 , and for $\text{Im } \lambda > 0$, the operator $\hat{P}(\lambda)$ is elliptic in this calculus in the microlocal sense (that is, elliptic as ξ and/or r go to infinity) – in fact, near $r = \infty$ the operator $\hat{P}(\lambda)$ is close to $\Delta_0 - \lambda^2$, where Δ_0 is the flat Laplacian on \mathbb{R}^3 . Moreover, $\hat{P}(\lambda)$ is a symmetric operator when $\lambda \in \mathbb{R}$. This implies that the proofs of [129, 35] apply. Similarly to [89, Theorem 2], for $\text{Im } \lambda > 0$, the operator $\hat{P}(\lambda)$ is Fredholm $H^2(\mathbb{R}^3) \rightarrow L^2(\mathbb{R}^3)$ and invertible for λ outside of a discrete set; we can then fix $E > 0$ such that $\hat{P}(\lambda + iE)$ is invertible for all $\lambda \in \mathbb{R}$.

Next, the Hamiltonian flow of the principal symbol $\hat{\mathbf{p}}(\omega)$ of $\hat{P}_h(\omega)$ corresponds to lightlike geodesics of the metric \hat{g} , similarly to (4.2.14). Therefore, this flow is nontrapping at all energies $\omega \neq 0$. By [129], we get for each $\chi_0 \in C_0^\infty(\mathbb{R}^3)$,

$$\|\chi_0 \hat{P}(\lambda + iE)^{-1} \chi_0\|_{L^2 \rightarrow L^2} \leq C \langle \lambda \rangle^{-1}, \quad \lambda \in \mathbb{R}; \quad (4.3.48)$$

in fact, the constant in the estimate is bounded as $E \rightarrow 0$, but we do not use this here. Finally, by [35, Lemma 2], we see that $\hat{P}_h(\omega + ihE)^{-1}$ is semiclassically outgoing for ω near $-\tau_0$, that is, the wavefront set of $\hat{u}_1(h^{-1}\omega + iE)$ is contained in the union of $\text{WF}_h(\hat{f}_1(h^{-1}\omega + iE))$ and all Hamiltonian flow lines of $\hat{\mathbf{p}}(\omega)$ starting on $\text{WF}_h(\hat{f}_1(h^{-1}\omega + iE)) \cap \{\hat{\mathbf{p}}(\omega) = 0\}$. Since no geodesic starting near $(\tilde{x}_0, \tilde{\xi}_0)$ intersects $\{r \leq R_1\}$ for positive times, we get $\text{WF}_h(\hat{u}_1(h^{-1}\omega +$

$iE)) \cap \overline{T^*} X_{\delta_1} = \emptyset$ for ω in a neighborhood of $-\tau_0$. For ω outside of this neighborhood, we use the rapid decay of $\hat{f}_1(\omega)$ established before, together with (4.3.48), to get

$$\hat{u}_1(\lambda + iE) = \mathcal{O}(h^\infty \langle \lambda \rangle^{-\infty})_{C^\infty(\{r < R_1\})}.$$

It remains to use the Fourier inversion formula

$$u_1(t) = \frac{1}{2\pi} \int_{\mathbb{R}} e^{-i(\lambda+iE)t} \hat{u}_1(\lambda + iE) d\lambda$$

to get (4.3.47). \square

Any solution satisfying (4.3.46) is trivial from the point of view of Theorems 4.1 and 4.2 (putting $u_{\Pi} = 0$). Therefore, we may assume that $\text{WF}_h(u) \cap \{t^* = 0\}$ is contained in a small neighborhood of some $(\tilde{x}, \tilde{\xi})$ such that the corresponding geodesic does not escape. By assumption (5) in §4.2.2, see also Lemma 4.2.2, we may assume that

$$\text{WF}_h(u) \cap \{t^* = 0\} \subset (\mathcal{C}_+ \cap \{\tau < 0\}) \cup (\mathcal{C}_- \cap \{\tau > 0\}),$$

here \mathcal{C}_\pm are defined in (4.2.6). We can reduce the case $\text{WF}(u) \cap \{t^* = 0\} \subset \mathcal{C}_-$ to the case $\text{WF}_h(u) \cap \{t^* = 0\} \subset \mathcal{C}_+$ by taking the complex conjugate of u , and take a dyadic partition of unity together with the natural rescaling of the problem $\tilde{\xi} \mapsto s\tilde{\xi}, h \mapsto sh$, to reduce to the case

$$\text{WF}_h(u) \cap \{t^* = 0\} \subset \mathcal{C}_+ \cap \{|1 + \tau| < \delta_1/8\}. \quad (4.3.49)$$

Proposition 4.3.11. *For $\widetilde{\text{WF}}_h(u)$ defined in §4.2.1, we have*

$$\widetilde{\text{WF}}_h(u) \subset \{|1 + \tau| < \delta_1/4\}. \quad (4.3.50)$$

Proof. Consider a function $\psi \in C_0^\infty(-1 - \delta_1/2, -1 + \delta_1/2)$ such that $\psi = 1$ near $[-1 - \delta_1/4, -1 + \delta_1/4]$. If u solves the wave equation on $(-\delta, \infty)$, then we extend it to a function on the whole $\widetilde{X}_{-\delta_1}$ smoothly and so that $\text{supp } u \subset \{t^* > -2\delta\}$. Define

$$u' := (1 - \psi(hD_{t^*}))u,$$

then, since the metric is stationary, $\square_{\tilde{g}} u' = (1 - \psi(hD_{t^*}))\square_{\tilde{g}} u = \mathcal{O}(h^\infty)_{\mathcal{S}(\widetilde{X}_{-\delta_1} \cap \{t^* \geq -\delta/2\})}$. By (4.3.49), we get $\text{WF}_h(u') \cap \{t^* = 0\} = \emptyset$. Then by the energy estimate (4.3.44), applied to u' , we get $\widetilde{\text{WF}}_h(u') = \emptyset$, uniformly in $t^* \in [0, T \log(1/h)]$. It remains to note that $\widetilde{\text{WF}}_h(\psi(hD_{t^*})u) \subset \{|1 + \tau| < \delta_1/4\}$. \square

We can now give

Proofs of Theorems 4.1 and 4.2. Without loss of generality (replacing δ_1 by $\delta_1/3$) we may assume that $\text{supp } f_0 \cup \text{supp } f_1 \subset X_{3\delta_1}$.

Choose small $t_\varepsilon > 0$ and a cutoff function $\chi = \chi(\mu)$, with $\text{supp } \chi \subset \{\mu > 2\delta_1\}$ and $\chi = 1$ near $\{\mu \geq 3\delta_1\}$, such that, with the flow $\tilde{\varphi}^t$ defined in (4.2.3),

$$(\tilde{x}, \tilde{\xi}) \in \text{supp } \chi, \tilde{\varphi}^{t_\varepsilon}(\tilde{x}, \tilde{\xi}) \in \text{supp}(1 - \chi), \tilde{\xi} \neq 0 \implies \frac{H_{\tilde{p}}}{\partial_{\tau\tilde{p}}}\mu(\tilde{\varphi}^{t_\varepsilon}(\tilde{x}, \tilde{\xi})) < 0. \quad (4.3.51)$$

The existence of such χ and t_ε follows from Proposition 4.3.1, see the proof of [47, Lemma 5.5(1)].

Take $N(h) = \lceil T \log(1/h)/t_\varepsilon \rceil$ and consider the functions $u^{(0)} := u$ and

$$\begin{aligned} u^{(j)} &\in C^\infty(\tilde{X}_{-\delta_1} \cap \{t^* \geq jt_\varepsilon\}), \quad 1 \leq j \leq N(h), \\ \square_{\tilde{g}} u^{(j)} &= 0, \quad u^{(j)}(jt_\varepsilon) = \chi u^{(j-1)}(jt_\varepsilon), \quad \partial_{t^*} u^{(j)}(jt_\varepsilon) = \chi \partial_{t^*} u^{(j-1)}(jt_\varepsilon). \end{aligned}$$

By (4.3.44), $u^{(j)}$ are h -tempered uniformly in j and in $t^* \in [jt_\varepsilon, T \log(1/h) + 2]$. Moreover, similarly to Proposition 4.3.11, we get $\widetilde{\text{WF}}_h(u^{(j)}) \subset \{|1 + \tau| < \delta_1/4\}$ uniformly in j . Then, $u^{(j)} - u^{(j-1)}$ are solutions to the wave equation with initial data $(1 - \chi)(u^{(j-1)}(jt_\varepsilon), \partial_{t^*} u^{(j-1)}(jt_\varepsilon))$, therefore by (4.3.51)

$$\text{WF}_h(u^{(j)} - u^{(j-1)}) \cap \{t^* = jt_\varepsilon\} \subset \{|1 + \tau| < \delta_1/4\} \cap \{\mu > \delta_1\} \cap \left\{ \frac{H_{\tilde{p}}}{\partial_{\tau\tilde{p}}}\mu < 0 \right\}.$$

Then all the trajectories of $\hat{\varphi}^s$ starting on $\text{WF}_h(u^{(j)} - u^{(j-1)}) \cap \{t^* = jt_\varepsilon\}$ escape as $s \rightarrow +\infty$; by Proposition 4.3.10, we see that

$$\widetilde{\text{WF}}_h(u^{(j)} - u^{(j-1)}) \cap \{\mu > \delta_1\} = \emptyset, \quad t^* \in [jt_\varepsilon + T_0, T \log(1/h)],$$

uniformly in j , where T_0 is a fixed large constant. Adding these up, we get

$$\widetilde{\text{WF}}_h(u^{(j)} - u) \cap \{\mu > \delta_1\} = \emptyset, \quad t^* \in [jt_\varepsilon + T_0, T \log(1/h)]. \quad (4.3.52)$$

By propagation of singularities for the wave equation and using that $\text{WF}_h(u^{(j)}) \cap \{t^* = jt_\varepsilon\} \subset \{\mu > 2\delta_1\}$, we see, uniformly in j ,

$$\text{WF}_h(u) \cap \{\delta_1 \leq \mu \leq 2\delta_1\} \cap \{jt_\varepsilon \leq t^* - T_0 \leq (j+1)t_\varepsilon\} \subset \{|1 + \tau| < \delta_1/4\} \cap \left\{ \frac{H_{\tilde{p}}}{\partial_{\tau\tilde{p}}}\mu < 0 \right\}.$$

Combining this with (4.3.52) (and another application of propagation of singularities for times up to T_0), we get uniformly in $t^* \in [0, T \log(1/h)]$,

$$\widetilde{\text{WF}}_h(u) \cap \{\delta_1 \leq \mu \leq 2\delta_1\} \subset \{|1 + \tau| < \delta_1/4\} \cap \left\{ \frac{H_{\tilde{p}}}{\partial_{\tau\tilde{p}}}\mu < 0 \right\}. \quad (4.3.53)$$

This implies that for any bounded fixed T_1 , the semiclassical singularities of $u(t + T_1)$ in X_{δ_1} come via propagation of singularities from the semiclassical singularities of $u(t)$ in X_{δ_1} – that is, no new singularities arrive from the outside. We can then apply propagation of

singularities to see that $\widetilde{\text{WF}}_h(u) \cap \{\mu > \delta_1\} \subset \mathcal{W}$ uniformly in $t^* \in [T_0, T \log(1/h)]$, where $\mathcal{W} \subset \mathcal{C}_+$ is constructed in Lemma 4.2.2; indeed, every trajectory of $\tilde{\varphi}^s$ starting on $\{|1 + \tau| < \delta_1/4\} \cap \{\mu > \delta_1\} \setminus \mathcal{W}$ escapes as $s \rightarrow +\infty$. Together with (4.3.50) and (4.3.53), this implies that for $t \geq T_0$, u satisfies the outgoing condition of Definition 4.2.3.

We can finally apply Theorem 4.4 in §4.2.4, giving Theorem 4.2 and additionally the bounds (the first one of which is a combination of (4.2.22), (4.2.23), and (4.2.25))

$$\begin{aligned} \|u(t)\|_{\mathcal{E}} &\leq C(h^{-1/2}e^{-(\nu_{\min}-\varepsilon)t/2} + h^{-1}e^{-(\nu_{\min}-\varepsilon)t} + h^N)\|u(0)\|_{\mathcal{E}}, \\ \|u(t)\|_{\mathcal{E}} &\leq Ce^{\varepsilon t}\|u(0)\|_{\mathcal{E}}. \end{aligned}$$

The first of these bounds gives Theorem 4.1 for $(\nu_{\min} - \varepsilon)t \geq \log(1/h)$; the second one gives

$$\|u(t)\|_{\mathcal{E}} \leq Ch^{-1/2}e^{-(\nu_{\min}-3\varepsilon)t/2}\|u(0)\|_{\mathcal{E}}, \quad (\nu_{\min} - \varepsilon)t \leq \log(1/h),$$

which is the bound of Theorem 4.1 with ε replaced by 3ε . \square

4.3.5 Results for resonances

In this section, we use the results of Chapter 3 together with the analysis of §§4.3.1, 4.3.2 to prove Theorem 4.3. As in the statement of this theorem, we consider the Kerr–de Sitter case $\Lambda > 0$.

We first use [128, §6] to define resonances for Kerr–de Sitter and put them into the framework of §3.4. We use the change of variables (4.3.41); the metric in the coordinates $(t^*, r, \theta, \varphi^*)$ continues smoothly through the event horizons to $\tilde{X}_{-\delta_1} = \{\mu > -\delta_1\}$, see [128, §6.1].

Following [128, §6.2] (but omitting the ρ^2 factor), we consider the stationary d’Alembert–Beltrami operator $P(z)$, obtained by replacing D_{t^*} by $-z \in \mathbb{C}$ in $\square_{\tilde{g}}$. It is an operator on the space slice $X_{-\delta_1} = \{\mu > -\delta_1\}_r \times S_{\theta, \varphi}^2$. We consider the semiclassical version

$$P_{\tilde{g}}(\omega) := h^2 P(h^{-1}\omega),$$

where $h \rightarrow 0$ is a small parameter; this definition agrees with the one used in §4.2.3.

Following [128, §6.5], we embed $X_{-\delta_1}$ as an open set into a compact manifold without boundary X , extend $P(z)$ to a second order differential operator on X depending holomorphically on z , and construct a complex absorbing operator $Q(z) \in \Psi^2(X)$, whose Schwartz kernel is supported inside the square of the nonphysical region $\{\mu < 0\}$. Then [128, Theorem 1.1] for $\text{Im } z \geq -C_1$ and s large enough depending on C_1 , $P(z) - iQ(z)$ is a holomorphic family of Fredholm operators $\mathcal{X}^s \rightarrow H^{s-1}(X)$, where

$$\mathcal{X}^s = \{u \in H^s(X) \mid (P(0) - iQ(0))u \in H^{s-1}(X)\},$$

and resonances are defined as the poles of its inverse. The semiclassical version is

$$\begin{aligned} \mathcal{P}(\omega) &:= P_{\tilde{g}}(\omega) - h^2 Q(h^{-1}\omega) : \mathcal{X}_h^s \rightarrow H_h^{s-1}(X), \\ \|u\|_{\mathcal{X}_h^s} &= \|u\|_{H_h^s(X)} + \|(P(0) - iQ(0))u\|_{H_h^{s-1}(X)}. \end{aligned} \tag{4.3.54}$$

We now claim that the operator $\mathcal{P}(\omega)$ satisfies all the assumptions of §§3.4.1, 3.5.1. Most of these assumptions have already been verified in §4.2.3, relying on the assumptions of §4.2.2 which in turn have been verified in §§4.3.1, 4.3.2. Given the definition of the spaces $\mathcal{H}_1 := \mathcal{X}_h^s$, $\mathcal{H}_2 := H_h^{s-1}(X)$, and the Fredholm property discussed above, it remains to verify assumptions (10) and (11) of §3.4.1, namely the existence of an outgoing parametrix. This is done by modifying the proof of [128, Theorem 2.15] exactly as at the end of §3.4.4.

Theorem 4.3 now follows directly by Theorems 3.1 and 3.2; the constant $c_{\tilde{K}}$ is given by (4.2.16).

4.3.6 Stability

We finally discuss stability of Theorems 4.1–4.3, under perturbations of the metric. We assume that (\tilde{X}_0, \tilde{g}) is a Lorentzian manifold which is a small smooth metric perturbation of the exact Kerr(–de Sitter) (as described in §4.3.1 and with M, Λ, a in a small neighborhood of either (4.1.1) or (4.1.2)) and which is moreover stationary (that is, ∂_t is Killing). For perturbations of Kerr ($\Lambda = 0$) spacetime, we moreover assume that our perturbation coincides with the exact metric for large r (this assumption can be relaxed; in fact, all we need is for (4.3.44) and the analysis in Proposition 4.3.10 to apply, so we may take a small perturbation in the class of scattering metrics). We also assume that the perturbation continues smoothly across the event horizons in the coordinates (4.3.41). The initial value problem (4.3.43) is then well-posed, as $\{\mu = -\delta_1\}$ is still spacelike. The results of [128] still hold, as discussed in [128, §2.7].

It remains to verify that the assumptions of §4.2.2 still hold for the perturbed metric. Assumptions (1)–(3) are obviously true. Assumption (4) holds with the same function μ , at least for $\mu(\gamma(s)) \in (\delta, \delta_0)$, where δ_0 is fixed and $\delta > 0$ is small depending on the size of the perturbation; we take a small enough perturbation so that $\delta \ll \delta_1$, where $\delta_1 \geq 0$ is the constant used in Theorem 4.4 in §4.2.4 and in (4.2.13). Then the trapped set \tilde{K} for the perturbed metric is close to the original trapped set, which implies assumption (5). Finally, the dynamical assumptions (6)–(8) still hold by the results of [64] and the semicontinuity of $\nu_{\min}, \nu_{\max}, \mu_{\max}$, as discussed in §3.5.2.

Bibliography

- [1] Jacques Aguilar and Jean-Michel Combes. “A class of analytic perturbations for one-body Schrödinger Hamiltonians”. In: *Comm. Math. Phys.* 22 (1971), pp. 269–279.
- [2] Sarp Akçay and Richard A Matzner. “The Kerr–de Sitter universe”. In: *Classical and Quantum Gravity* 28.8 (2011), p. 085012.
- [3] B. P. Abbott et al. “Search for gravitational wave ringdowns from perturbed black holes in LIGO S4 data”. In: *Phys. Rev. D* 80 (6 Sept. 2009), p. 062001.
- [4] Lars Andersson and Pieter Blue. *Hidden symmetries and decay for the wave equation on the Kerr spacetime*. arXiv: [0908.2265](https://arxiv.org/abs/0908.2265).
- [5] Stefanos Aretakis. “Decay of axisymmetric solutions of the wave equation on extreme Kerr backgrounds”. In: *J. Funct. Anal.* 263.9 (2012), pp. 2770–2831.
- [6] Stefanos Aretakis. “Stability and instability of extreme Reissner-Nordström black hole spacetimes for linear scalar perturbations I”. In: *Comm. Math. Phys.* 307.1 (2011), pp. 17–63.
- [7] Stefanos Aretakis. “Stability and instability of extreme Reissner-Nordström black hole spacetimes for linear scalar perturbations II”. In: *Ann. Henri Poincaré* 12.8 (2011), pp. 1491–1538.
- [8] Alain Bachelot. “Gravitational scattering of electromagnetic field by Schwarzschild black-hole”. In: *Ann. Inst. H. Poincaré Phys. Théor.* 54.3 (1991), pp. 261–320.
- [9] Alain Bachelot. “Scattering of electromagnetic field by de Sitter-Schwarzschild black hole”. In: *Nonlinear hyperbolic equations and field theory (Lake Como, 1990)*. Vol. 253. Pitman Res. Notes Math. Ser. Harlow: Longman Sci. Tech., 1992, pp. 23–35.
- [10] Alain Bachelot and Agnès Motet-Bachelot. “Les résonances d’un trou noir de Schwarzschild”. In: *Ann. Inst. H. Poincaré Phys. Théor.* 59.1 (1993), pp. 3–68.
- [11] Matania Ben-Artzi and Allen Devinatz. “Resolvent estimates for a sum of tensor products with applications to the spectral theory of differential operators”. In: *J. Analyse Math.* 43 (1983/84), pp. 215–250.
- [12] Jean-Pierre Berenger. “A perfectly matched layer for the absorption of electromagnetic waves”. In: *J. Comput. Phys.* 114.2 (1994), pp. 185–200.

- [13] Emanuele Berti, Vitor Cardoso, and Andrei O Starinets. “Quasinormal modes of black holes and black branes”. In: *Classical and Quantum Gravity* 26.16 (2009), p. 163001.
- [14] Emanuele Berti, Vitor Cardoso, and Clifford M. Will. “Gravitational-wave spectroscopy of massive black holes with the space interferometer LISA”. In: *Phys. Rev. D* 73 (6 Mar. 2006), p. 064030.
- [15] Emanuele Berti and Kostas D. Kokkotas. “Quasinormal modes of Kerr-Newman black holes: Coupling of electromagnetic and gravitational perturbations”. In: *Phys. Rev. D* 71 (12 June 2005), p. 124008.
- [16] Pieter Blue and Jacob Sterbenz. “Uniform decay of local energy and the semi-linear wave equation on Schwarzschild space”. In: *Comm. Math. Phys.* 268.2 (2006), pp. 481–504.
- [17] Jean-François Bony and Dietrich Häfner. “Decay and non-decay of the local energy for the wave equation on the de Sitter-Schwarzschild metric”. In: *Comm. Math. Phys.* 282.3 (2008), pp. 697–719.
- [18] Jean-François Bony et al. “Spectral projection, residue of the scattering amplitude and Schrödinger group expansion for Barrier-top resonances”. In: *Ann. Inst. Fourier (Grenoble)* 61.4 (2011), 1351–1406 (2012).
- [19] Nicolas Burq and Maciej Zworski. “Control for Schrödinger operators on tori”. In: *Math. Res. Lett.* 19.2 (2012), pp. 309–324.
- [20] Brandon Carter. “Hamilton-Jacobi and Schrödinger separable solutions of Einstein’s equations”. In: *Comm. Math. Phys.* 10 (1968), pp. 280–310.
- [21] Subrahmanyan Chandrasekhar. *The mathematical theory of black holes*. Oxford Classic Texts in the Physical Sciences. Reprint of the 1992 edition. New York: The Clarendon Press Oxford University Press, 1998, pp. xxii+646.
- [22] Anne-Marie Charbonnel. “Spectre conjoint d’opérateurs pseudodifférentiels qui commutent”. In: *C. R. Acad. Sci. Paris Sér. I Math.* 293.2 (1981), pp. 147–150.
- [23] Tanya Christiansen and Maciej Zworski. “Resonance wave expansions: two hyperbolic examples”. In: *Comm. Math. Phys.* 212.2 (2000), pp. 323–336.
- [24] Demetrios Christodoulou and Sergiu Klainerman. *The global nonlinear stability of the Minkowski space*. Vol. 41. Princeton Mathematical Series. Princeton, NJ: Princeton University Press, 1993, pp. x+514.
- [25] Yves Colin de Verdière. “Bohr-Sommerfeld rules to all orders”. In: *Ann. Henri Poincaré* 6.5 (2005), pp. 925–936.
- [26] Yves Colin de Verdière and Victor Guillemin. “A semi-classical inverse problem I: Taylor expansions”. In: *Geometric aspects of analysis and mechanics*. Vol. 292. Progr. Math. Birkhäuser/Springer, New York, 2011, pp. 81–95.

- [27] Yves Colin de Verdière and Bernard Parisse. “Équilibre instable en régime semi-classique. I. Concentration microlocale”. In: *Comm. Partial Differential Equations* 19.9-10 (1994), pp. 1535–1563.
- [28] Mihalis Dafermos and Igor Rodnianski. “A proof of the uniform boundedness of solutions to the wave equation on slowly rotating Kerr backgrounds”. In: *Invent. Math.* 185.3 (2011), pp. 467–559.
- [29] Mihalis Dafermos and Igor Rodnianski. *Decay for solutions of the wave equation on Kerr exterior space-times I-II: The cases of $|a| \ll M$ or axisymmetry*. arXiv: [1010.5132](#).
- [30] Mihalis Dafermos and Igor Rodnianski. *Lectures on black holes and linear waves*. arXiv: [0811.0354v1](#).
- [31] Mihalis Dafermos and Igor Rodnianski. “The black hole stability problem for linear scalar perturbations”. In: *Proceedings of the 12 Marcel Grossmann Meeting*. 2012. arXiv: [1010.5137](#).
- [32] Mihalis Dafermos and Igor Rodnianski. “The red-shift effect and radiation decay on black hole spacetimes”. In: *Comm. Pure Appl. Math.* 62.7 (2009), pp. 859–919.
- [33] Mihalis Dafermos and Igor Rodnianski. *The wave equation on Schwarzschild–de Sitter spacetimes*. arXiv: [0709.2766](#).
- [34] Kiril Datchev. “Distribution of resonances for manifolds with hyperbolic ends”. PhD thesis. University of California, Berkeley, 2010.
- [35] Kiril Datchev. “Local smoothing for scattering manifolds with hyperbolic trapped sets”. In: *Comm. Math. Phys.* 286.3 (2009), pp. 837–850.
- [36] Kiril Datchev and Semyon Dyatlov. “Fractal Weyl laws for asymptotically hyperbolic manifolds”. In: *Geom. Funct. Anal.* (to appear). arXiv: [1206.2255](#).
- [37] Kiril Datchev, Semyon Dyatlov, and Maciej Zworski. “Sharp polynomial bounds on the number of Pollicott–Ruelle resonances”. In: *Erg. Theory Dyn. Syst.* (to appear). arXiv: [1208.4330](#).
- [38] Kiril Datchev and András Vasy. “Gluing Semiclassical Resolvent Estimates via Propagation of Singularities”. In: *International Mathematics Research Notices* 2012.23 (2012), pp. 5409–5443.
- [39] Mouez Dimassi and Johannes Sjöstrand. *Spectral asymptotics in the semi-classical limit*. Vol. 268. London Mathematical Society Lecture Note Series. Cambridge: Cambridge University Press, 1999, pp. xii+227.
- [40] Dmitry Dolgopyat. “On decay of correlations in Anosov flows”. In: *Ann. of Math. (2)* 147.2 (1998), pp. 357–390.
- [41] Roland Donniger, Wilhelm Schlag, and Avy Soffer. “A proof of Price’s law on Schwarzschild black hole manifolds for all angular momenta”. In: *Adv. Math.* 226.1 (2011), pp. 484–540.

- [42] Roland Donniger, Wilhelm Schlag, and Avy Soffer. “On pointwise decay of linear waves on a Schwarzschild black hole background”. In: *Comm. Math. Phys.* 309.1 (2012), pp. 51–86.
- [43] Johannes Duistermaat. “On global action-angle coordinates”. In: *Comm. Pure Appl. Math.* 33.6 (1980), pp. 687–706.
- [44] Johannes Duistermaat and Victor Guillemin. “The spectrum of positive elliptic operators and periodic bicharacteristics”. In: *Invent. Math.* 29.1 (1975), pp. 39–79.
- [45] Nelson Dunford and Jacob T. Schwartz. *Linear Operators. I. General Theory*. With the assistance of W. G. Bade and R. G. Bartle. Pure and Applied Mathematics, Vol. 7. Interscience Publishers, Inc., New York, 1958, pp. xiv+858.
- [46] Semyon Dyatlov. “Exponential energy decay for Kerr–de Sitter black holes beyond event horizons”. In: *Math. Res. Lett.* 18.5 (2011), pp. 1023–1035.
- [47] Semyon Dyatlov and Colin Guillarmou. *Microlocal limits of plane waves and Eisenstein functions*. arXiv: [1204.1305](#).
- [48] Frédéric Faure and Johannes Sjöstrand. “Upper bound on the density of Ruelle resonances for Anosov flows”. In: *Comm. Math. Phys.* 308.2 (2011), pp. 325–364.
- [49] Frédéric Faure and Masato Tsujii. *Band structure of the Ruelle spectrum of contact Anosov flows*. arXiv: [1301.5525](#).
- [50] Frédéric Faure and Masato Tsujii. *Prequantum transfer operator for Anosov diffeomorphism (preliminary version)*. arXiv: [1206.0282](#).
- [51] Frédéric Faure and Masato Tsujii. “Spectrum and zeta function of contact Anosov flows”. In preparation.
- [52] Felix Finster et al. “Decay of solutions of the wave equation in the Kerr geometry”. In: *Comm. Math. Phys.* 264.2 (2006), pp. 465–503.
- [53] Felix Finster et al. “Erratum: “Decay of solutions of the wave equation in the Kerr geometry” [Comm. Math. Phys. **264** (2006), no. 2, 465–503]”. In: *Comm. Math. Phys.* 280.2 (2008), pp. 563–573.
- [54] Oran Gannot. *Quasinormal modes for AdS–Schwarzschild black holes: exponential convergence to the real axis*. arXiv: [1212.1907](#).
- [55] Christian Gérard and Johannes Sjöstrand. “Resonances en limite semiclassique et exposants de Lyapunov”. In: *Comm. Math. Phys.* 116.2 (1988), pp. 193–213.
- [56] Christian Gérard and Johannes Sjöstrand. “Semiclassical resonances generated by a closed trajectory of hyperbolic type”. In: *Comm. Math. Phys.* 108.3 (1987), pp. 391–421.
- [57] Israel C. Gohberg and Efim I. Sigal. “An operator generalization of the logarithmic residue theorem and Rouché’s theorem”. In: *Mat. Sb. (N.S.)* 84(126) (1971), pp. 607–629.

- [58] Arseni Goussev et al. “Quantum theory of reactive scattering in phase space”. In: *Adv. Quant. Chem.* 60 (2010), pp. 269–332.
- [59] Alain Grigis and Johannes Sjöstrand. *Microlocal analysis for differential operators*. Vol. 196. London Mathematical Society Lecture Note Series. An introduction. Cambridge: Cambridge University Press, 1994, pp. iv+151.
- [60] Colin Guillarmou. “Meromorphic properties of the resolvent on asymptotically hyperbolic manifolds”. In: *Duke Math. J.* 129.1 (2005), pp. 1–37.
- [61] Victor Guillemin and Shlomo Sternberg. *Geometric asymptotics*. Mathematical Surveys, No. 14. Providence, R.I.: American Mathematical Society, 1977, xviii+474 pp. (one plate).
- [62] Victor Guillemin and Shlomo Sternberg. “Semi-classical analysis”. lecture notes (version of January 13, 2010).
- [63] Laurent Guillopé, Kevin K. Lin, and Maciej Zworski. “The Selberg zeta function for convex co-compact Schottky groups”. In: *Comm. Math. Phys.* 245.1 (2004), pp. 149–176.
- [64] Morris W. Hirsch, Charles C. Pugh, and Michael Shub. *Invariant manifolds*. Lecture Notes in Mathematics, Vol. 583. Berlin: Springer-Verlag, 1977, pp. ii+149.
- [65] Michael Hitrik and Johannes Sjöstrand. “Non-selfadjoint perturbations of selfadjoint operators in 2 dimensions. I”. In: *Ann. Henri Poincaré* 5.1 (2004), pp. 1–73.
- [66] Michael Hitrik, Johannes Sjöstrand, and San Vũ Ngọc. “Diophantine tori and spectral asymptotics for nonselfadjoint operators”. In: *Amer. J. Math.* 129.1 (2007), pp. 105–182.
- [67] Shahar Hod. *Resonance spectrum of near-extremal Kerr black holes in the eikonal limit*. arXiv: [1207.5282](https://arxiv.org/abs/1207.5282).
- [68] Gustav Holzegel and Jacques Smulevici. *Decay properties of Klein-Gordon fields on Kerr-AdS spacetimes*. arXiv: [1110.6794](https://arxiv.org/abs/1110.6794).
- [69] Gustav Holzegel and Jacques Smulevici. *Quasimodes and a lower bound on the uniform energy decay rate for Kerr-AdS spacetimes*. arXiv: [1303.5944](https://arxiv.org/abs/1303.5944).
- [70] Lars Hörmander. *The analysis of linear partial differential operators. I*. Vol. 256. Grundlehren der Mathematischen Wissenschaften [Fundamental Principles of Mathematical Sciences]. Distribution theory and Fourier analysis. Berlin: Springer-Verlag, 1990, pp. xii+440.
- [71] Lars Hörmander. *The analysis of linear partial differential operators. III*. Vol. 274. Grundlehren der Mathematischen Wissenschaften [Fundamental Principles of Mathematical Sciences]. Pseudo-differential operators, Corrected reprint of the 1985 original. Berlin: Springer-Verlag, 1994, pp. viii+525.

- [72] Lars Hörmander. *The analysis of linear partial differential operators. IV*. Vol. 275. Grundlehren der Mathematischen Wissenschaften [Fundamental Principles of Mathematical Sciences]. Fourier integral operators, Corrected reprint of the 1985 original. Berlin: Springer-Verlag, 1994, pp. viii+352.
- [73] Lars Hörmander. “The spectral function of an elliptic operator”. In: *Acta Math.* 121 (1968), pp. 193–218.
- [74] Gary T. Horowitz and Veronika E. Hubeny. “Quasinormal modes of AdS black holes and the approach to thermal equilibrium”. In: *Phys. Rev. D* 62 (2 June 2000), p. 024027.
- [75] Alexei Iantchenko, Johannes Sjöstrand, and Maciej Zworski. “Birkhoff normal forms in semi-classical inverse problems”. In: *Math. Res. Lett.* 9.2-3 (2002), pp. 337–362.
- [76] Dmitry Jakobson and Frédéric Naud. “Lower bounds for resonances of infinite-area Riemann surfaces”. In: *Anal. PDE* 3.2 (2010), pp. 207–225.
- [77] Bernard S. Kay and Robert M. Wald. “Linear stability of Schwarzschild under perturbations which are non-vanishing on the bifurcation 2-sphere”. In: *Classical and Quantum Gravity* 4.4 (1987), p. 893.
- [78] N.K. Kofinti. “Scattering of a Klein-Gordon particle by a black hole”. English. In: *International Journal of Theoretical Physics* 23 (10 1984), pp. 991–999.
- [79] Kostas D. Kokkotas and Bernd G. Schmidt. “Quasi-normal modes of stars and black holes”. In: *Living Rev. Relativ.* 2 (1999), 1999–2, 73 pp. (electronic).
- [80] Peter D. Lax and Ralph S. Phillips. “Decaying modes for the wave equation in the exterior of an obstacle.” In: *Comm. Pure Appl. Math.* 22 (1969), pp. 737–787.
- [81] Carlangelo Liverani. “On contact Anosov flows”. In: *Ann. of Math. (2)* 159.3 (2004), pp. 1275–1312.
- [82] Jonathan Luk. *A Vector Field Method Approach to Improved Decay for Solutions to the Wave Equation on a Slowly Rotating Kerr Black Hole*. arXiv: [1009.0671](https://arxiv.org/abs/1009.0671).
- [83] Jonathan Luk. “Improved decay for solutions to the linear wave equation on a Schwarzschild black hole”. In: *Ann. Henri Poincaré* 11.5 (2010), pp. 805–880.
- [84] Alexandr S. Markus. *Introduction to the spectral theory of polynomial operator pencils*. Vol. 71. Translations of Mathematical Monographs. Translated from the Russian by H. H. McFaden, Translation edited by Ben Silver, With an appendix by M. V. Keldysh. Providence, RI: American Mathematical Society, 1988, pp. iv+250.
- [85] André Martinez. “Resonance free domains for non globally analytic potentials”. In: *Ann. Henri Poincaré* 3.4 (2002), pp. 739–756.
- [86] Jeremy Marzuola et al. “Strichartz estimates on Schwarzschild black hole backgrounds”. In: *Comm. Math. Phys.* 293.1 (2010), pp. 37–83.

- [87] Rafe R. Mazzeo and Richard B. Melrose. “Meromorphic extension of the resolvent on complete spaces with asymptotically constant negative curvature”. In: *J. Funct. Anal.* 75.2 (1987), pp. 260–310.
- [88] Rafe Mazzeo and András Vasy. “Resolvents and Martin boundaries of product spaces”. In: *Geom. Funct. Anal.* 12.5 (2002), pp. 1018–1079.
- [89] Richard B. Melrose. “Spectral and scattering theory for the Laplacian on asymptotically Euclidean spaces”. In: *Spectral and scattering theory (Sanda, 1992)*. Vol. 161. Lecture Notes in Pure and Appl. Math. New York: Dekker, 1994, pp. 85–130.
- [90] Richard B. Melrose, Antônio Sá Barreto, and András Vasy. *Asymptotics of solutions of the wave equation on de Sitter–Schwarzschild space*. arXiv: [0811.2229](#).
- [91] Richard Melrose and Maciej Zworski. “Scattering metrics and geodesic flow at infinity”. In: *Invent. Math.* 124.1-3 (1996), pp. 389–436.
- [92] Jason Metcalfe, Daniel Tataru, and Mihai Tohaneanu. “Price’s law on nonstationary space-times”. In: *Adv. Math.* 230.3 (2012), pp. 995–1028.
- [93] Werner Müller. “Spectral geometry and scattering theory for certain complete surfaces of finite volume”. In: *Invent. Math.* 109.2 (1992), pp. 265–305.
- [94] Stéphane Nonnenmacher. “Spectral problems in open quantum chaos”. In: *Nonlinearity* 24.12 (2011), R123.
- [95] Stéphane Nonnenmacher, Johannes Sjöstrand, and Maciej Zworski. “Fractal Weyl law for open quantum chaotic maps”. In: *Ann. of Math. (2)* (to appear). arXiv: [1105.3128](#).
- [96] Stéphane Nonnenmacher, Johannes Sjöstrand, and Maciej Zworski. “From open quantum systems to open quantum maps”. In: *Comm. Math. Phys.* 304.1 (2011), pp. 1–48.
- [97] Stéphane Nonnenmacher and Maciej Zworski. *Decay of correlations for normally hyperbolic trapping*. arXiv: [1302.4483](#).
- [98] Stéphane Nonnenmacher and Maciej Zworski. “Quantum decay rates in chaotic scattering”. In: *Acta Math.* 203.2 (2009), pp. 149–233.
- [99] David W. Pravica. “Top resonances of a black hole”. In: *R. Soc. Lond. Proc. Ser. A Math. Phys. Eng. Sci.* 455.1988 (1999), pp. 3003–3018.
- [100] Thierry Ramond. “Semiclassical study of quantum scattering on the line”. In: *Comm. Math. Phys.* 177.1 (1996), pp. 221–254.
- [101] Tullio Regge. “Analytic properties of the scattering matrix”. In: *Nuovo Cimento (10)* 8 (1958), pp. 671–679.
- [102] G. Risaliti et al. “A rapidly spinning supermassive black hole at the centre of NGC 1365”. In: *Nature* 494 (2013), pp. 449–451.

- [103] Antônio Sá Barreto and Maciej Zworski. “Distribution of resonances for spherical black holes”. In: *Math. Res. Lett.* 4.1 (1997), pp. 103–121.
- [104] Yakov Shlapentokh-Rothman. *Exponentially growing finite energy solutions for the Klein–Gordon equation on sub-extremal Kerr spacetimes*. arXiv: [1302.3448](#).
- [105] Yakov Shlapentokh-Rothman. *Quantitative Mode Stability for the Wave Equation on the Kerr Spacetime*. arXiv: [1302.6902](#).
- [106] Johannes Sjöstrand. “A trace formula and review of some estimates for resonances”. In: *Microlocal analysis and spectral theory (Lucca, 1996)*. Vol. 490. NATO Adv. Sci. Inst. Ser. C Math. Phys. Sci. Dordrecht: Kluwer Acad. Publ., 1997, pp. 377–437.
- [107] Johannes Sjöstrand. “Asymptotic distribution of eigenfrequencies for damped wave equations”. In: *Publ. Res. Inst. Math. Sci.* 36.5 (2000), pp. 573–611.
- [108] Johannes Sjöstrand. “Geometric bounds on the density of resonances for semiclassical problems”. In: *Duke Math. J.* 60.1 (1990), pp. 1–57.
- [109] Johannes Sjöstrand. “Resonances for bottles and trace formulae”. In: *Math. Nachr.* 221 (2001), pp. 95–149.
- [110] Johannes Sjöstrand. “Semiclassical resonances generated by nondegenerate critical points”. In: *Pseudodifferential operators (Oberwolfach, 1986)*. Vol. 1256. Lecture Notes in Math. Berlin: Springer, 1987, pp. 402–429.
- [111] Johannes Sjöstrand. “Semi-excited states in nondegenerate potential wells”. In: *Asymptotic Anal.* 6.1 (1992), pp. 29–43.
- [112] Johannes Sjöstrand. *Weyl law for semi-classical resonances with randomly perturbed potentials*. arXiv: [1111.3549](#).
- [113] Johannes Sjöstrand and Georgi Vodev. “Asymptotics of the number of Rayleigh resonances”. In: *Math. Ann.* 309.2 (1997). With an appendix by Jean Lannes, pp. 287–306.
- [114] Johannes Sjöstrand and Maciej Zworski. “Asymptotic distribution of resonances for convex obstacles”. In: *Acta Math.* 183.2 (1999), pp. 191–253.
- [115] Johannes Sjöstrand and Maciej Zworski. “Complex scaling and the distribution of scattering poles”. In: *J. Amer. Math. Soc.* 4.4 (1991), pp. 729–769.
- [116] Johannes Sjöstrand and Maciej Zworski. “Fractal upper bounds on the density of semiclassical resonances”. In: *Duke Math. J.* 137.3 (2007), pp. 381–459.
- [117] Johannes Sjöstrand and Maciej Zworski. “Quantum monodromy and semi-classical trace formulae”. In: *J. Math. Pures Appl. (9)* 81.1 (2002), pp. 1–33.
- [118] Plamen Stefanov and Georgi Vodev. “Distribution of resonances for the Neumann problem in linear elasticity outside a strictly convex body”. In: *Duke Math. J.* 78.3 (1995), pp. 677–714.

- [119] Siu-Hung Tang and Maciej Zworski. “From quasimodes to resonances”. In: *Math. Res. Lett.* 5.3 (1998), pp. 261–272.
- [120] Siu-Hung Tang and Maciej Zworski. “Resonance expansions of scattered waves”. In: *Comm. Pure Appl. Math.* 53.10 (2000), pp. 1305–1334.
- [121] Daniel Tataru. “Local decay of waves on asymptotically flat stationary space-times”. In: *Amer. J. Math.* (to appear). arXiv: [0910.5290](https://arxiv.org/abs/0910.5290).
- [122] Daniel Tataru and Mihai Tohaneanu. “A local energy estimate on Kerr black hole backgrounds”. In: *Int. Math. Res. Not. IMRN* 2 (2011), pp. 248–292.
- [123] Michael E. Taylor. *Partial differential equations I. Basic theory*. Second. Vol. 115. Applied Mathematical Sciences. New York: Springer, 2011, pp. xxii+654.
- [124] Edward Charles Titchmarsh. *The theory of the Riemann zeta-function*. Second. Edited and with a preface by D. R. Heath-Brown. New York: The Clarendon Press Oxford University Press, 1986, pp. x+412.
- [125] Mihai Tohaneanu. “Strichartz estimates on Kerr black hole backgrounds”. In: *Trans. Amer. Math. Soc.* 364.2 (2012), pp. 689–702.
- [126] Masato Tsujii. *Contact Anosov flows and the FBI transform*. arXiv: [1010.0396](https://arxiv.org/abs/1010.0396).
- [127] Andás Vasy. “Microlocal analysis of asymptotically hyperbolic spaces and high energy resolvent estimates”. In: *Inverse Problems and Applications. Inside Out II*, edited by Gunther Uhlmann, Cambridge University Press, MSRI publications 60 (2012). arXiv: [1104.1376v2](https://arxiv.org/abs/1104.1376v2).
- [128] András Vasy. “Microlocal analysis of asymptotically hyperbolic and Kerr–de Sitter spaces”. In: *Invent. Math.* (to appear). with an appendix by Semyon Dyatlov. arXiv: [1012.4391v2](https://arxiv.org/abs/1012.4391v2).
- [129] András Vasy and Maciej Zworski. “Semiclassical estimates in asymptotically Euclidean scattering”. In: *Comm. Math. Phys.* 212.1 (2000), pp. 205–217.
- [130] San Vũ Ngọc. *Systèmes intégrables semi-classiques: du local au global*. Vol. 22. Panoramas et Synthèses [Panoramas and Syntheses]. Paris: Société Mathématique de France, 2006, pp. vi+156.
- [131] Robert M. Wald. “Note on the stability of the Schwarzschild metric”. In: *Journal of Mathematical Physics* 20.6 (1979), pp. 1056–1058.
- [132] Jared Wunsch and Maciej Zworski. “Resolvent estimates for normally hyperbolic trapped sets”. In: *Ann. Henri Poincaré* 12.7 (2011), pp. 1349–1385.
- [133] Huan Yang et al. “Branching of quasinormal modes for nearly extremal Kerr black holes”. In: *Phys. Rev. D* 87 (4 Feb. 2013), p. 041502.
- [134] Huan Yang et al. “Quasinormal-mode spectrum of Kerr black holes and its geometric interpretation”. In: *Phys. Rev. D* 86 (10 Nov. 2012), p. 104006.

- [135] Shijun Yoshida, Nami Uchikata, and Toshifumi Futamase. “Quasinormal modes of Kerr–de Sitter black holes”. In: *Phys. Rev. D* 81 (4 Feb. 2010), p. 044005.
- [136] Maciej Zworski. “Distribution of poles for scattering on the real line”. In: *J. Funct. Anal.* 73.2 (1987), pp. 277–296.
- [137] Maciej Zworski. *Semiclassical analysis*. Vol. 138. Graduate Studies in Mathematics. Providence, RI: American Mathematical Society, 2012, pp. xii+431.