



Fibonacci Numbers and the Golden Ratio:

Natural Beauty through Optimization

Ken Kamrin

SPAMS 12/6/05

Golden Essentials

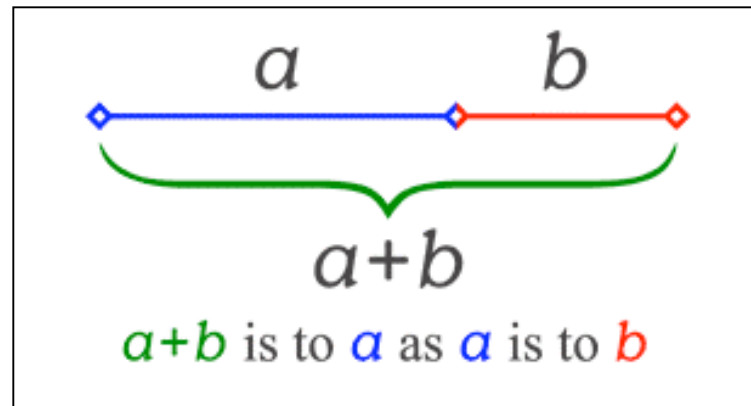

$$\text{Golden Ratio} \equiv \phi = \frac{a}{b} = \frac{a+b}{a} = \frac{b}{a-b}$$

$$\phi \approx 1.618033988\dots$$

(AKA Golden Section, Golden Mean, Divine Section)

More Specifics

$$\frac{a}{b} = \frac{a+b}{a} \implies \left(\frac{a}{b}\right)^2 = \frac{a}{b} + 1$$

$$\implies \boxed{\phi^2 = \phi + 1}$$

Solve the quadratic. Get solution $\frac{1 \pm \sqrt{5}}{2}$. Take positive root.

$$\boxed{\phi = \frac{1 + \sqrt{5}}{2}}$$



- ϕ is algebraic. Differs from π and e which are transcendental.
- ϕ is Euclidean; i.e. the ratio can be constructed with a compass and straight edge.

$$\phi^2 = \phi + 1 \implies \begin{cases} \phi = \sqrt{\phi + 1} \implies \phi = \sqrt{1 + \sqrt{1 + \sqrt{1 + \dots}}} \\ \phi = 1 + \frac{1}{\phi} \implies \phi = 1 + \frac{1}{1 + \frac{1}{1 + \frac{1}{1 + \dots}}} \end{cases}$$

Why do we care?

- Apparent in humans:

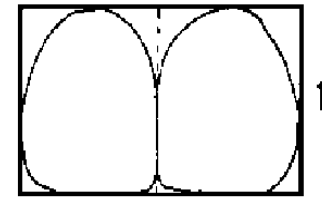
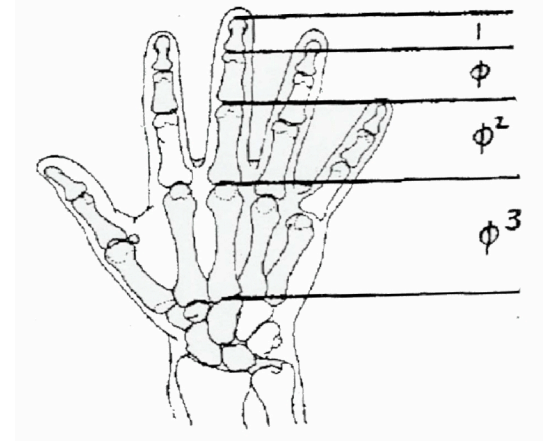
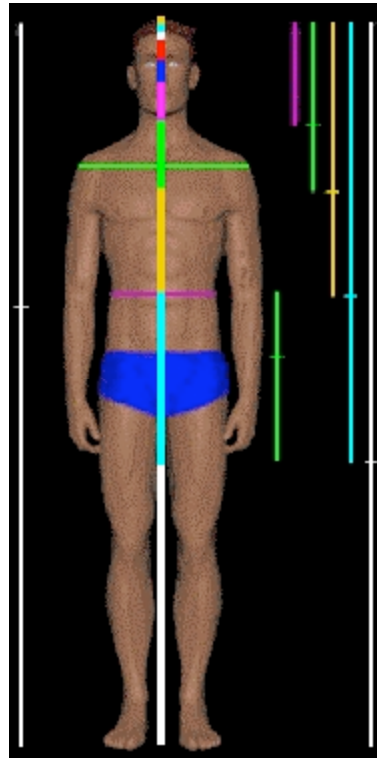
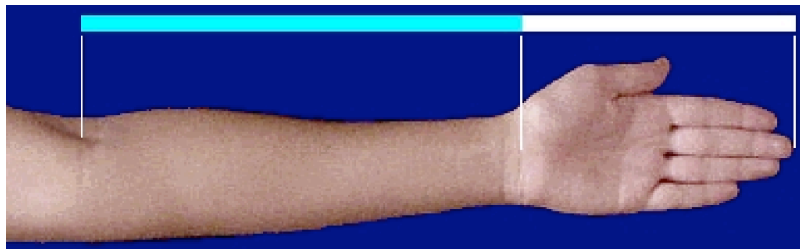

1.618



- **Apparent in botany:**

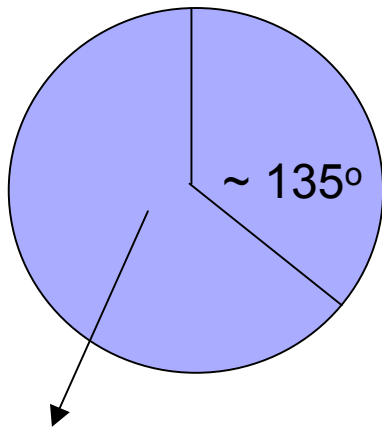

“Golden Angle” = $360^\circ/\phi \sim 225^\circ$

Phyllotaxy

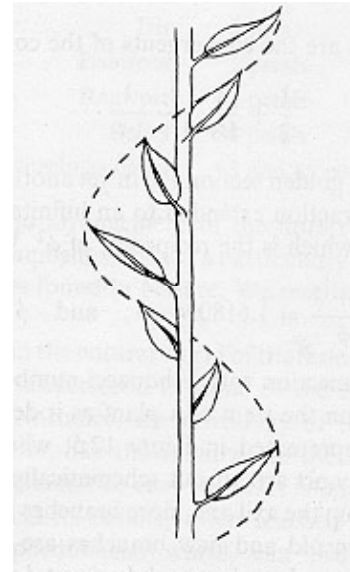

Seed Heads



Eerie connections to 5

$$\phi = .5 * 5^{.5} + .5 = \sqrt{\frac{5 + \sqrt{5}}{5 - \sqrt{5}}}$$

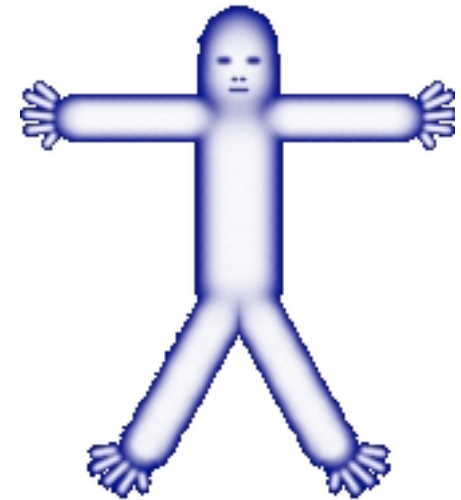
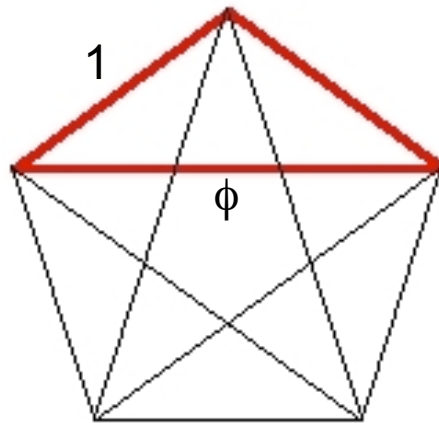
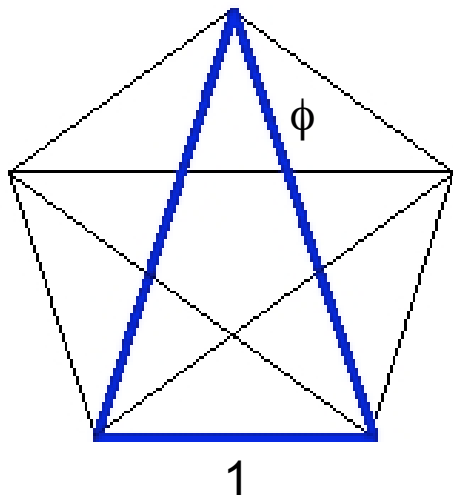

Golden Shapes

Golden Rectangle

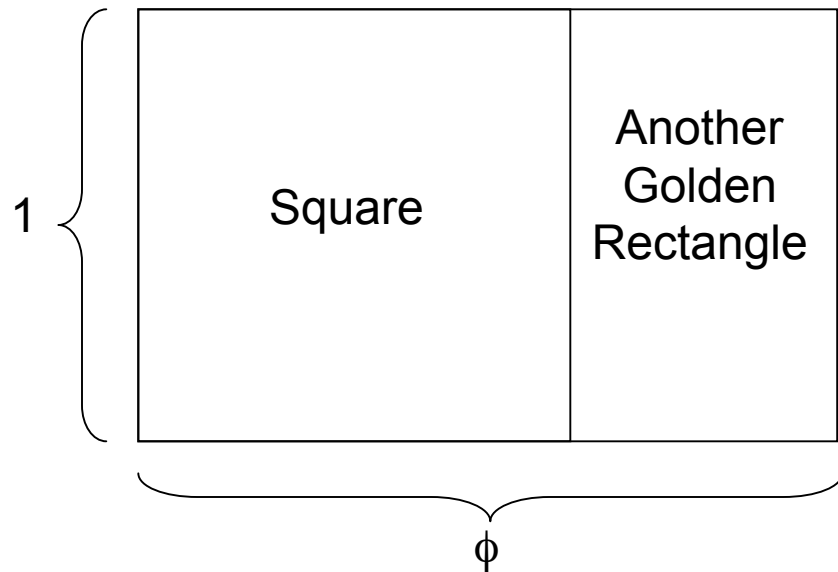

Golden Triangle

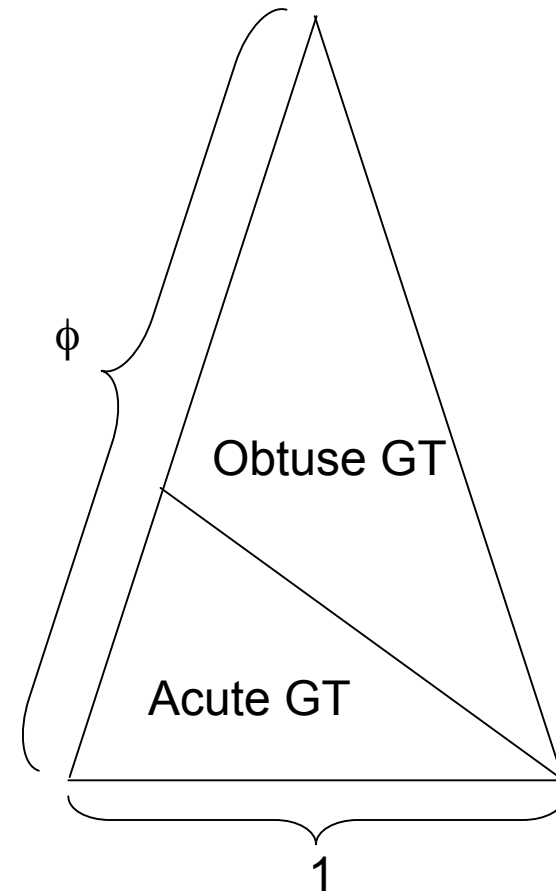



Golden Spirals

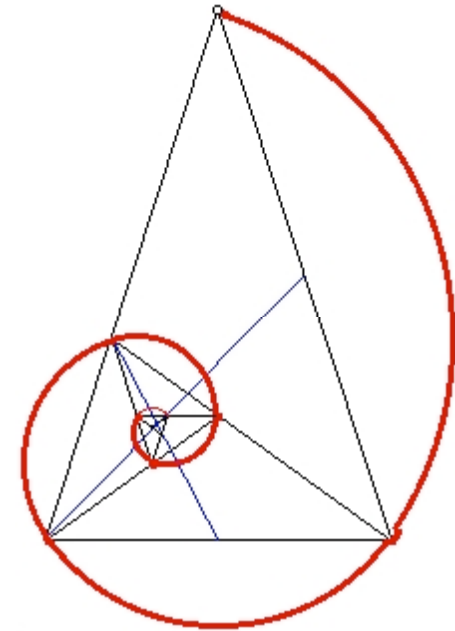
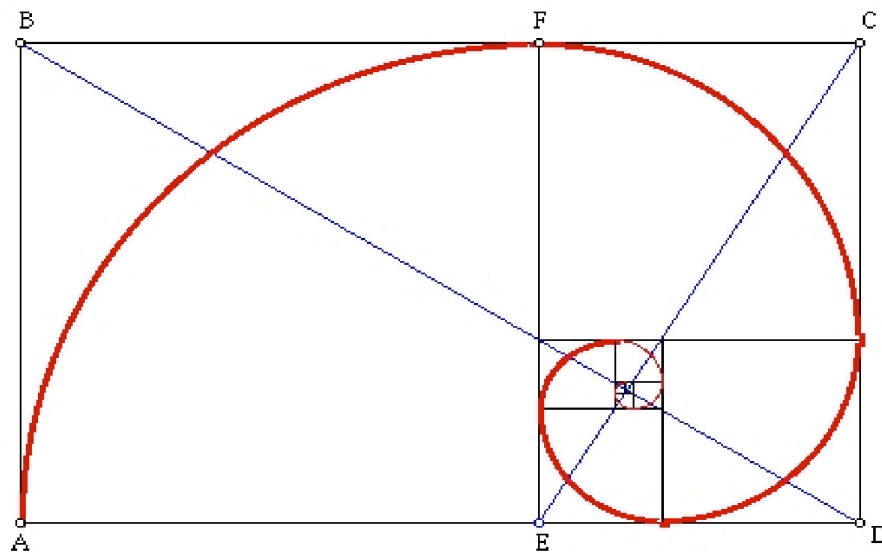

Interesting...

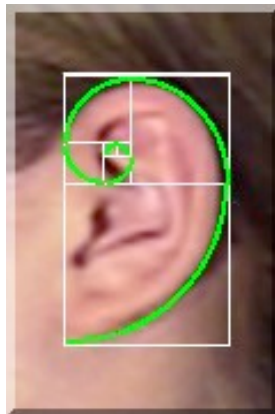



Fibonacci Numbers

$$F(n + 1) = F(n) + F(n - 1)$$

$$F(0) = 0, \quad F(1) = 1$$

0, 1, 1, 2, 3, 5, 8, 13, 21, 34, 55, 89, 144, ...

- Earliest reference given by an Indian mathematician named Pingala in 500BC.
- Next, Gopala and Hemachandra in 1150 described the Fibonacci while investigating the bin packing problem (the problem is NP-hard).
- In the West, circa 1200, Leonardo of Pisa (AKA Fibonacci) studied the numbers in an effort to describe rabbit population.

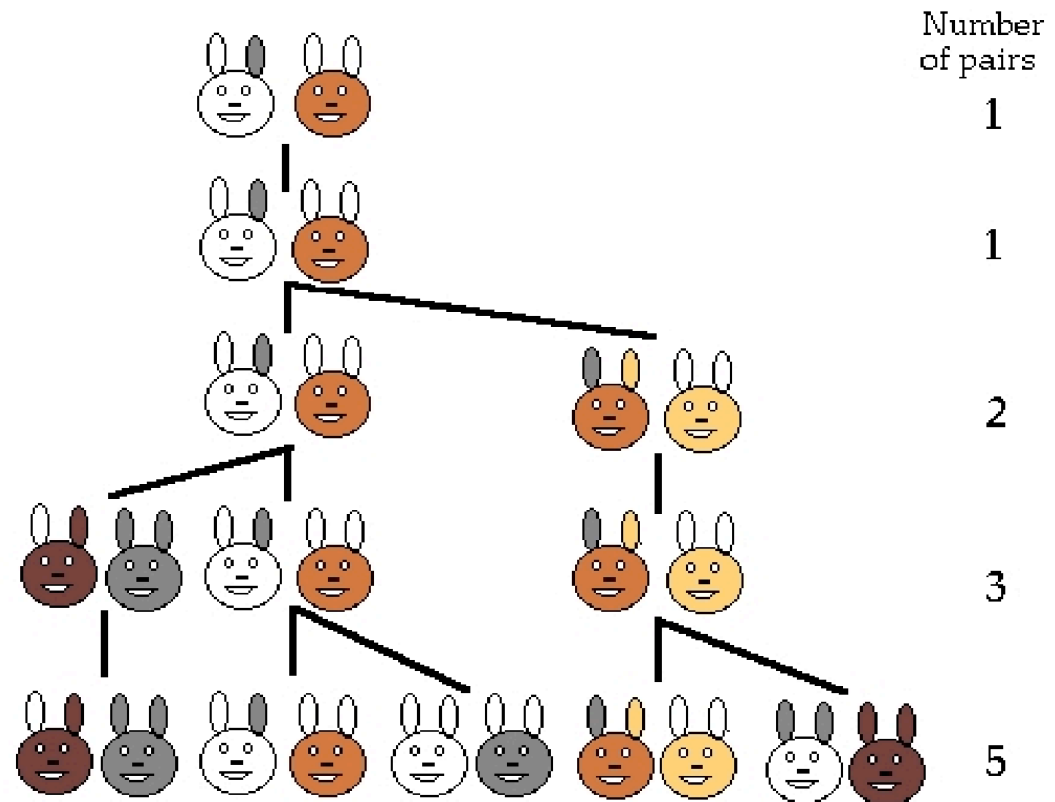
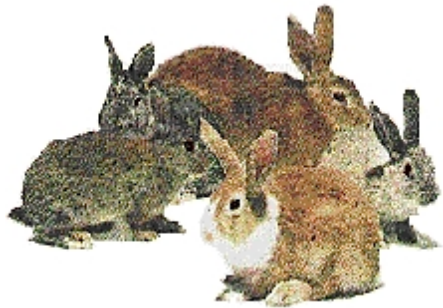

- In the first month there is just one newly-born pair.
- New-born pairs become fertile on their second month.
- On each month every fertile pair begets a new pair.
- Assume rabbits never die.

Elsewhere in Nature

Bee family tree:

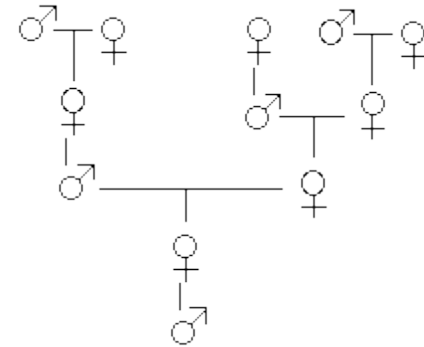
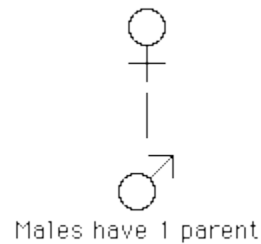
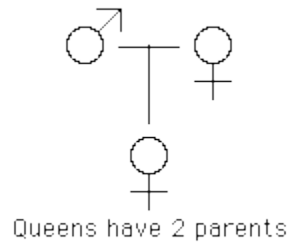

“sneezewort” diagrams

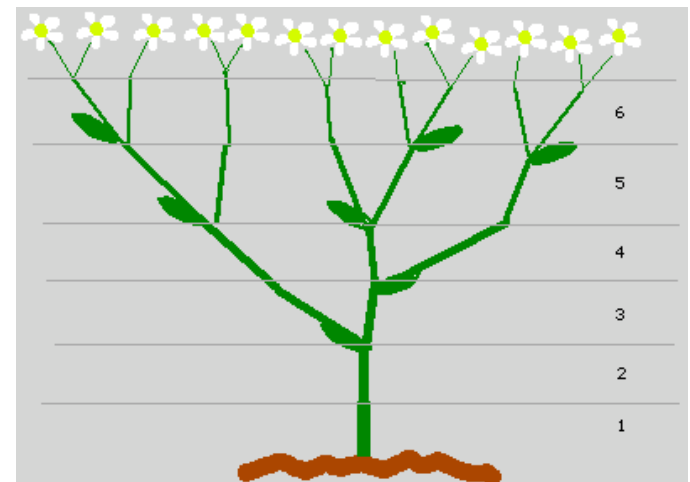



1



2



3



5



8



13



21



34

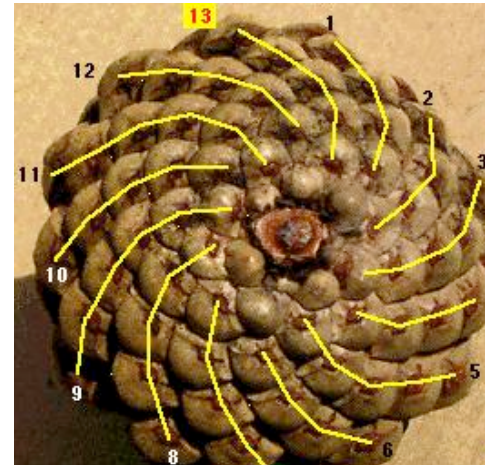
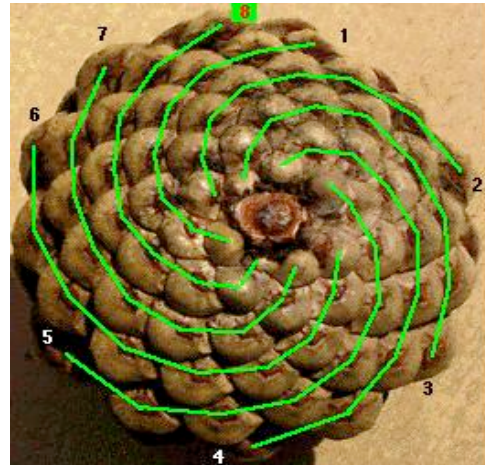



Phi-bonacci

- $\lim_{n \rightarrow \infty} \frac{F(n+1)}{F(n)} = \phi$
- $F(n) = \frac{1}{\sqrt{5}}(\phi^n - (1-\phi)^n)$ [Binet's Formula]
- $\phi^n = F(n-1)\phi + F(n-2)$

Plant Spirals

In plant spirals like seed heads (or pinecones, pineapple scales), the seeds are generated along some small circle in the center and at some constant angle from the previous seed. Seeds move outward radially over time. Plants have evolved such that space is most efficiently used on the entire seed head, allowing room for seeds to grow while moving farther out.

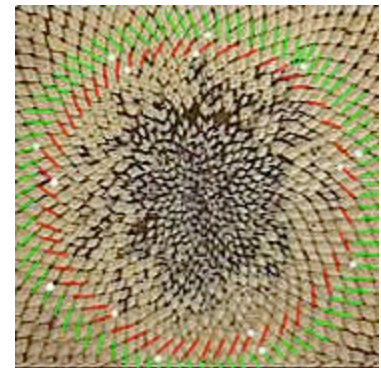

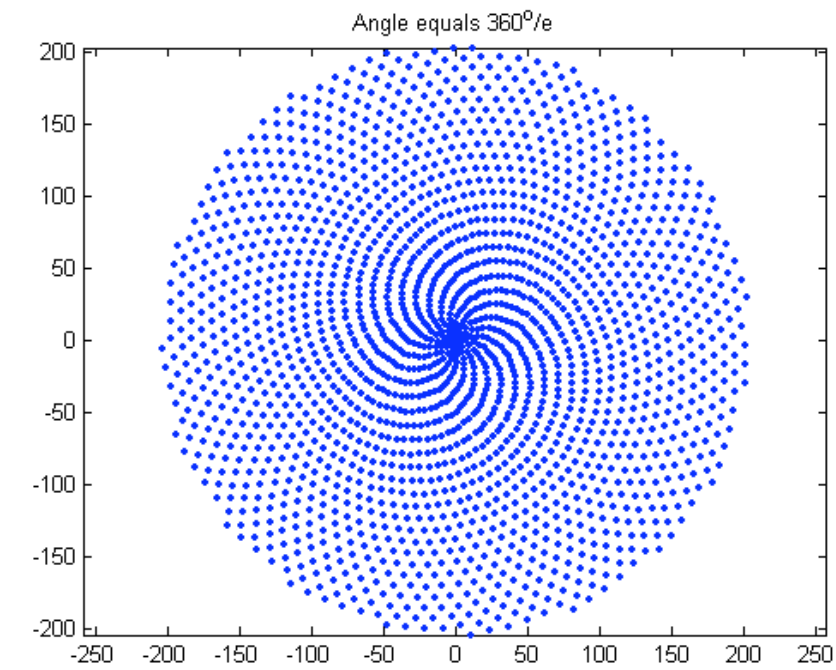
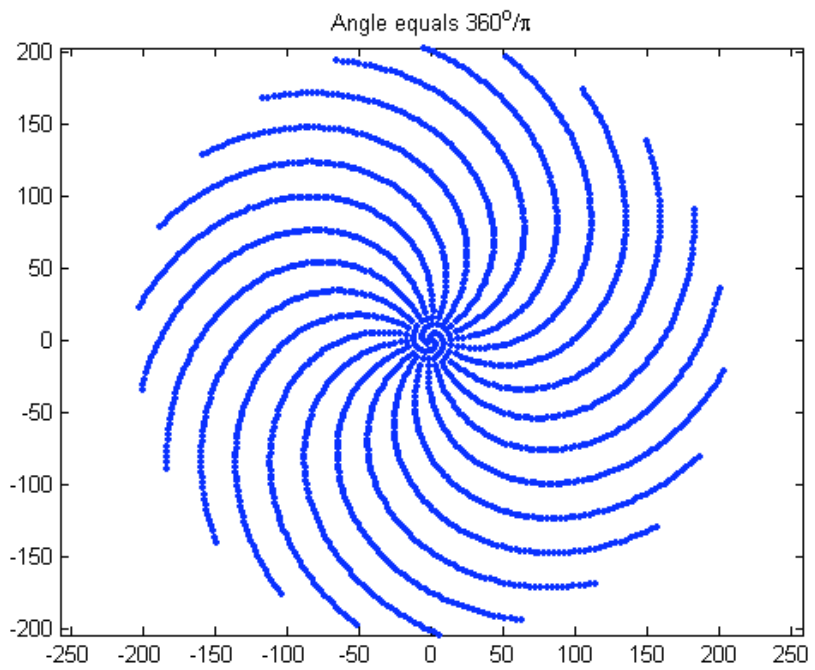
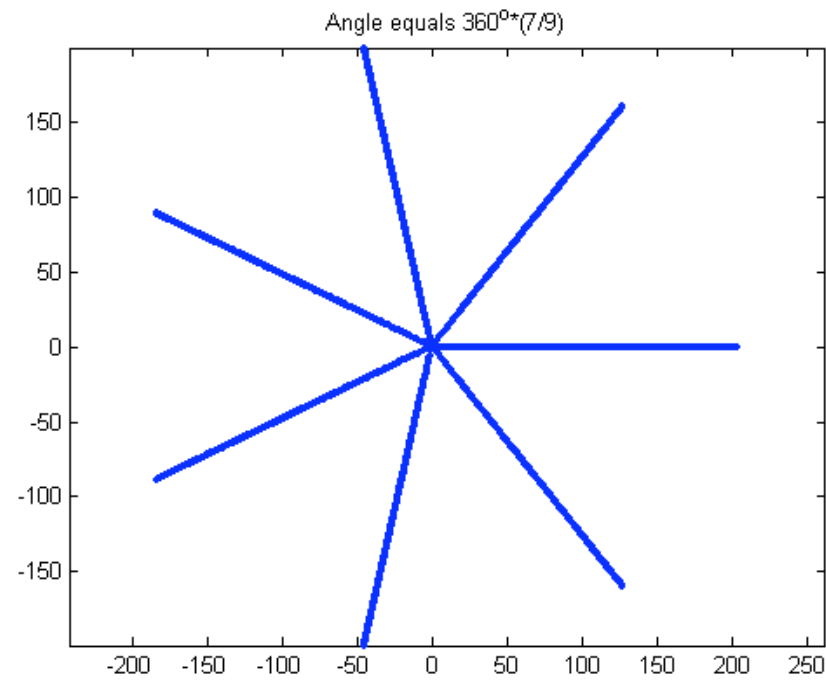
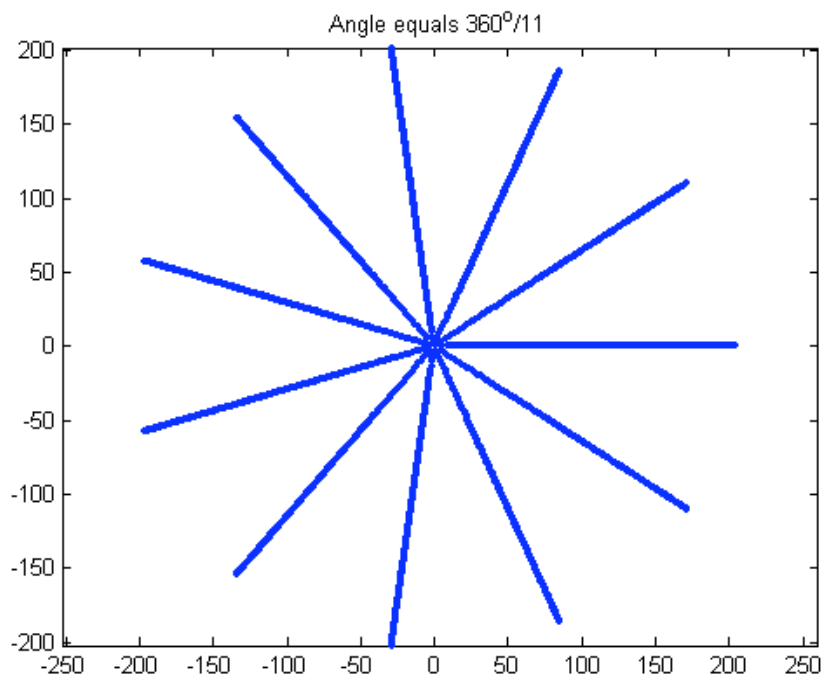

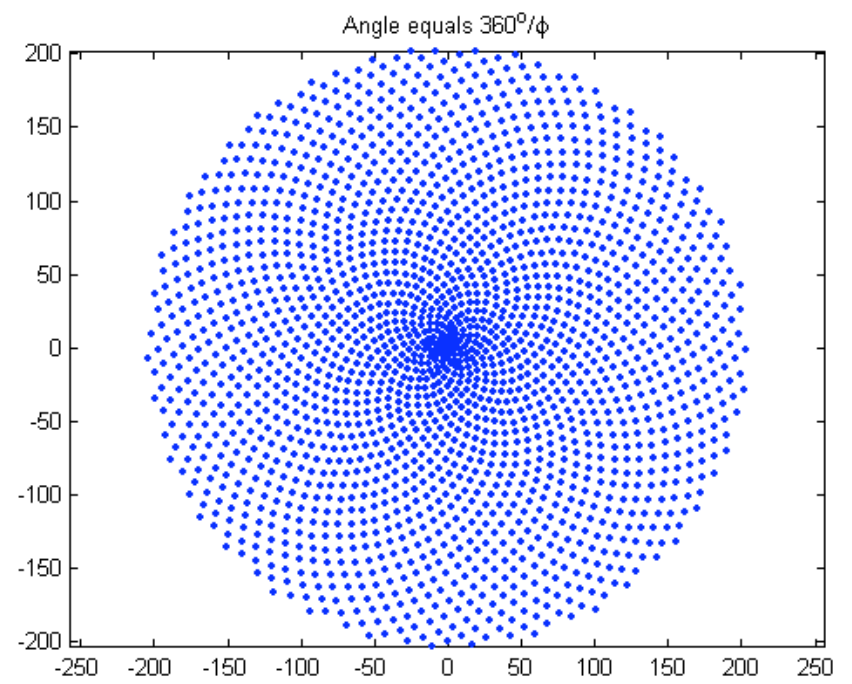
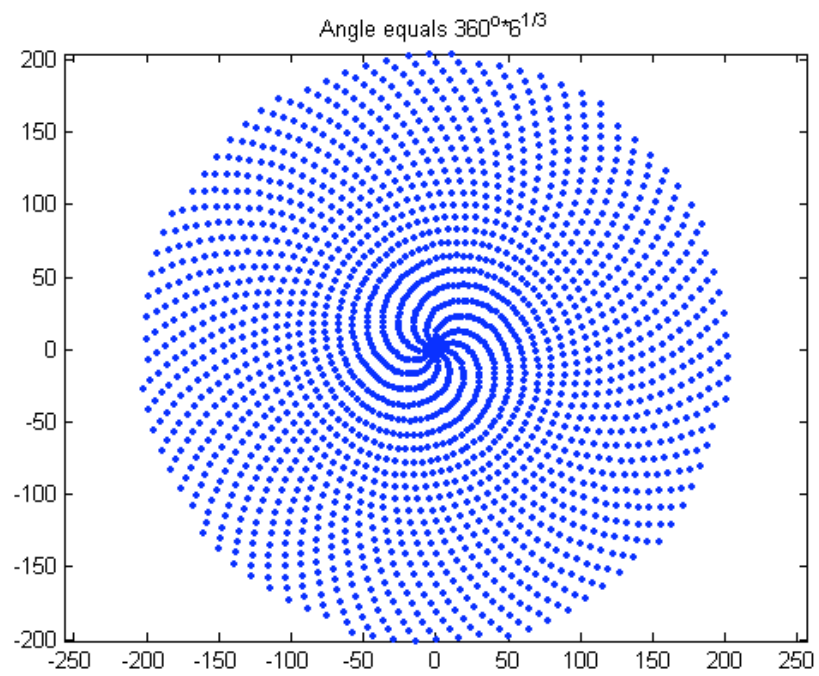
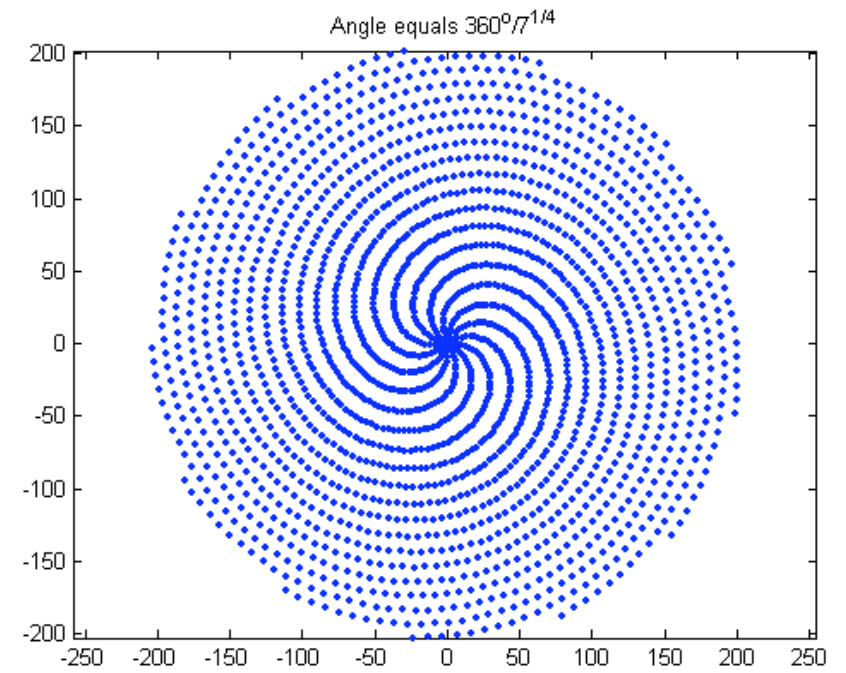
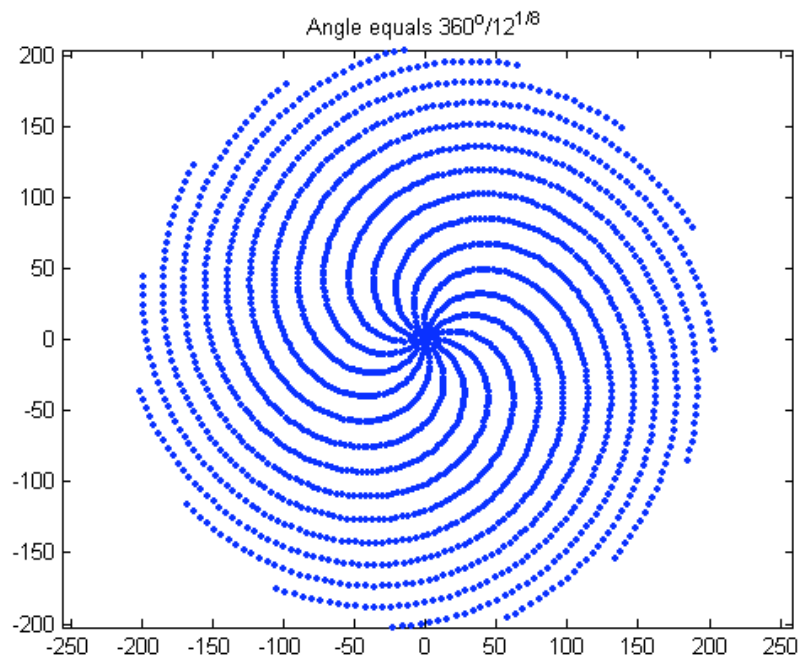



Comments on Seed Simulations

- For angles of the form $360 \cdot p/q$ for integers p, q , seed pattern develops q straight spokes. Lot's of wasted space.
- For angles of the form $360 \cdot \alpha$ for α irrational there are a few possible outcomes:
 - i) α close to a rational p/q , gives q spiraling spokes in a distance range proportional to q from the center. Some wasted space.
 - ii) α "far" from any rational p/q gives a more uniform distribution of seeds. Minimal wasted space
 - iii) Lower degree algebraic irrationals α give better distributions of seeds with the best occurring at ϕ .
- How do we define what we mean by "far" from any rational? How do we determined the best possible rational approximations?



Continued Fractions

Any irrational number α can be uniquely represented by a continued fraction of positive integers a_k ; i.e.

$$\alpha = a_0 + \frac{1}{a_1 + \frac{1}{a_2 + \frac{1}{a_3 + \dots}}}$$

which we abbreviate as $\alpha = [a_0; a_1, a_2, a_3, \dots]$.

The n^{th} *convergent* of α , denoted $[a_0; a_1, \dots, a_n] = \frac{p_n}{q_n}$, is the rational number one receives by ending the continued fraction after writing a_n .



Theorem: The convergents of an irrational number α are the best rational approximations to α in the sense that

$$|q_n\alpha - p_n| < |q\alpha - p|$$

for any $q < q_n$ and $\frac{p}{q} \neq \frac{p_n}{q_n}$.

Example: $\pi = [3; 7, 15, 1, 292, 1, 1, 1, \dots]$

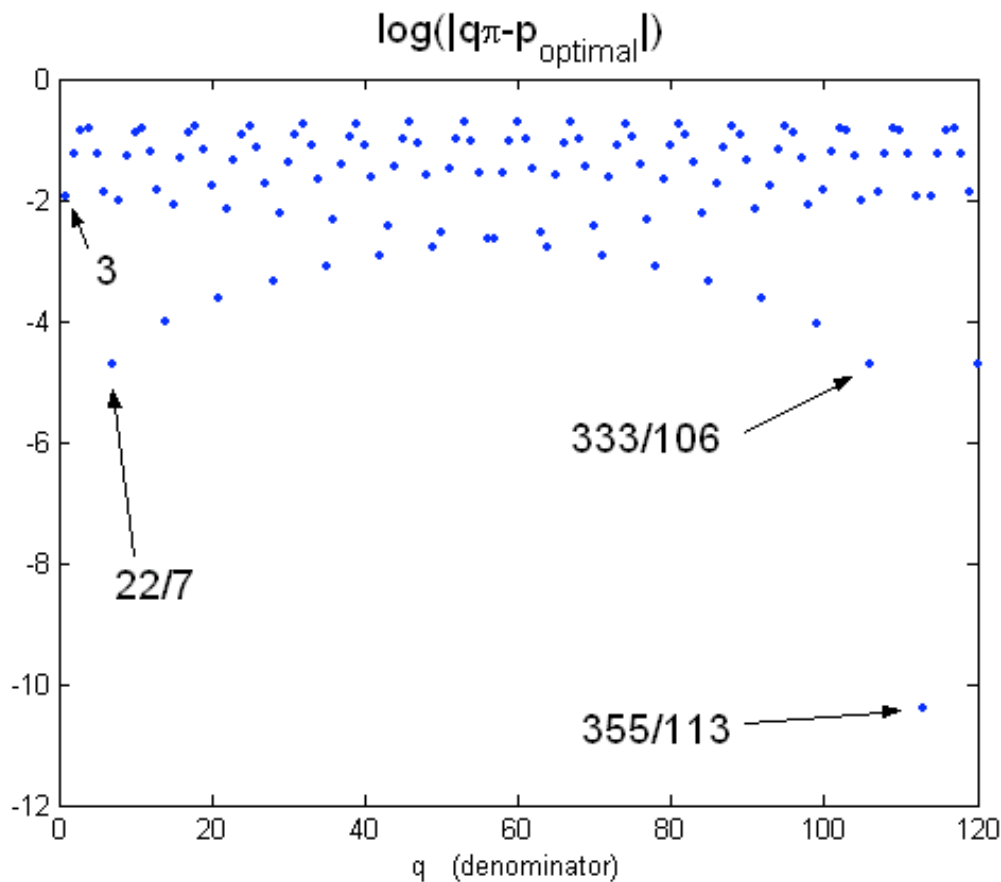

Convergents:

$$p_0/q_0 = 3$$

$$p_1/q_1 = 3 + \frac{1}{7} = \frac{22}{7}$$

$$p_2/q_2 = 3 + \frac{1}{7 + \frac{1}{15}} = \frac{333}{106}$$

$$p_3/q_3 = 3 + \frac{1}{7 + \frac{1}{15 + \frac{1}{1}}} = \frac{355}{113}$$

In our seed head optimization problem with $\text{angle}=360^\circ/\alpha$, the number of spiraling spokes we see at various distances from the center increases through α 's $\{p_n\}$ sequence. We see p_n spirals develop more fully (and waste more space) when $p_{n+1}-p_n$ is large.

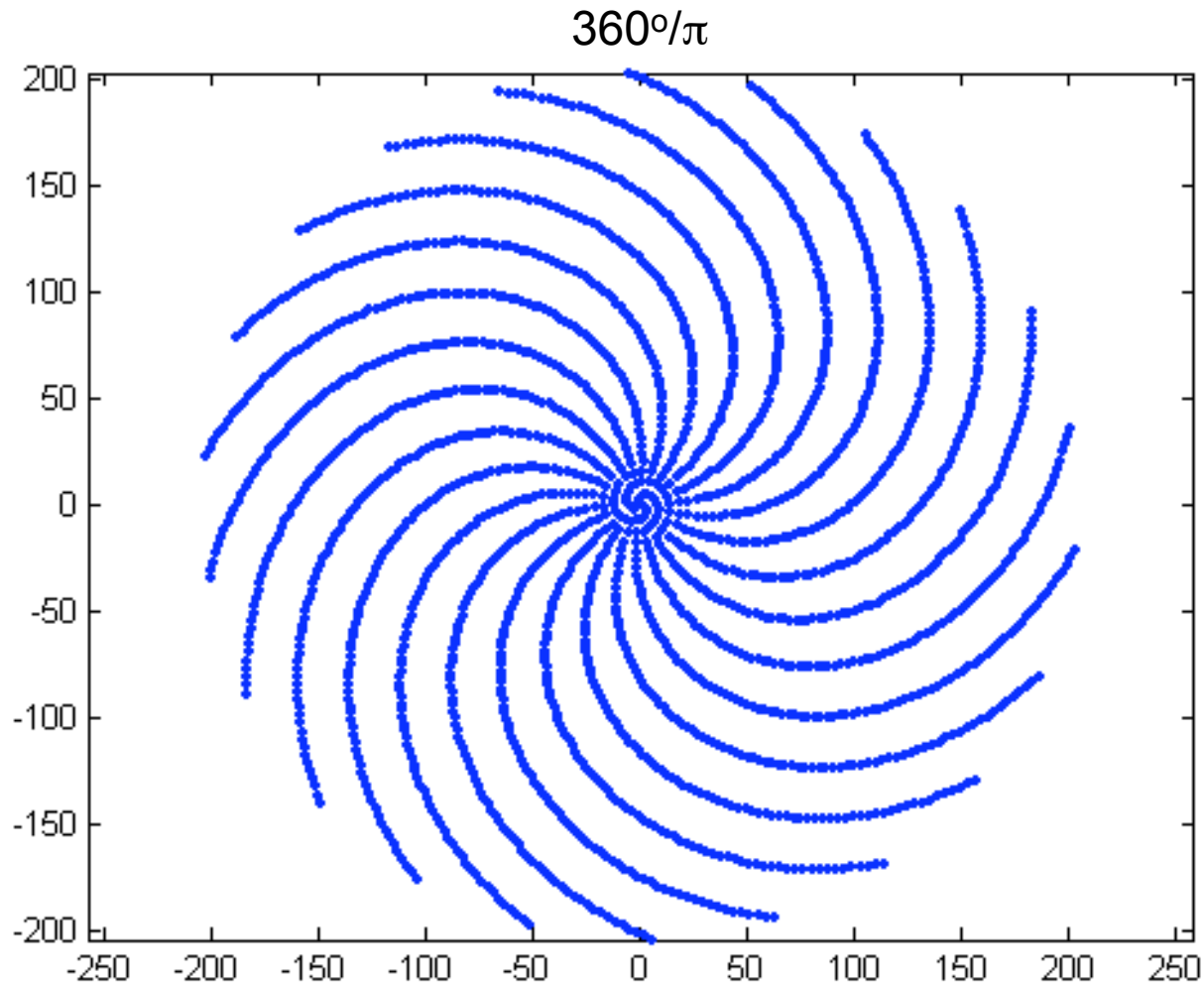

Simple algebraic manipulations on the definition of a continued fraction give us the following results for $n > 0$:

$$q_n = a_n q_{n-1} + q_{n-2}$$

$$p_n = a_n p_{n-1} + p_{n-2}$$

So if we want to minimize the distance between all neighboring p_n , we need to choose an α whose continued fraction has the smallest a_n 's, i.e.

$$\alpha = [1; 1, 1, 1, 1, \dots].$$



Recalling $\phi = 1 + \frac{1}{\phi} \implies \phi = 1 + \frac{1}{1 + \frac{1}{1 + \frac{1}{1 + \dots}}}$

Answer: ~~ϕ~~ !!!

Its convergents are ratios of consecutive Fibonacci numbers, explaining the number of spirals we count.

Phyllotaxy

In phyllotaxy, plants have evolved to sprout leaves in such a way that leaves higher up on the stalk do not block sunlight from reaching the lower leaves. The dense leaf assembly also maximizes rainwater exposure.

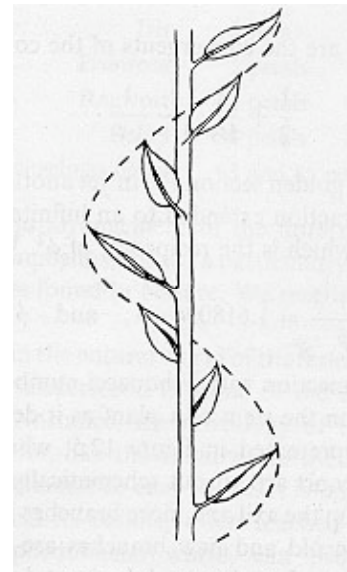

Goal: Find the inter-leaf angle $360^\circ/\alpha$ such that $|\alpha - p_n/q_n|$ stays large compared to q_n .



Approximation Theorems

Liouville's: If α is irrational and solves an m^{th} order polynomial with integer coefficients, then

$$|\alpha - p_n/q_n| > K/q_n^m$$

for some $K > 0$.

Surprised? The *simplest* irrational numbers (i.e. soln's to quadratics) are the *hardest* to approximate with rationals. Thus we can rule out anything but irrational quadratic solutions.



Dirichlet's: For α irrational, infinitely many of the convergents fulfill

$$|\alpha - p_n/q_n| < 1/q_n^2.$$

This means that regardless of what kind of irrational α is, there will always be an infinite subset of convergents that approach α somewhat quickly ($<1/\text{denominator}^2$).

Hurwitz': Modifying the Dirichlet bound, we write

$$|\alpha - p_n/q_n| < L(\alpha)/q_n^2$$

where $L(\alpha) < 1$, called the *Lagrange number*, provides the tightest bound for α .



The very largest Lagrange numbers are in the range $(1/3, 1/\sqrt{5}]$ and form a discrete set. This enables us to discern families of irrationals ranked in order of worst to best approximated with rationals. The first two families are fully represented by one number allowing us to rank the first and second "worst" irrational numbers.

Rank		Lagrange number
1 st	ϕ	$L(\phi) = \frac{1}{\sqrt{5}}$
2 nd	$1 + \sqrt{2}$	$L(1 + \sqrt{2}) = \frac{1}{\sqrt{8}}$

Closeness of Rational Approximations

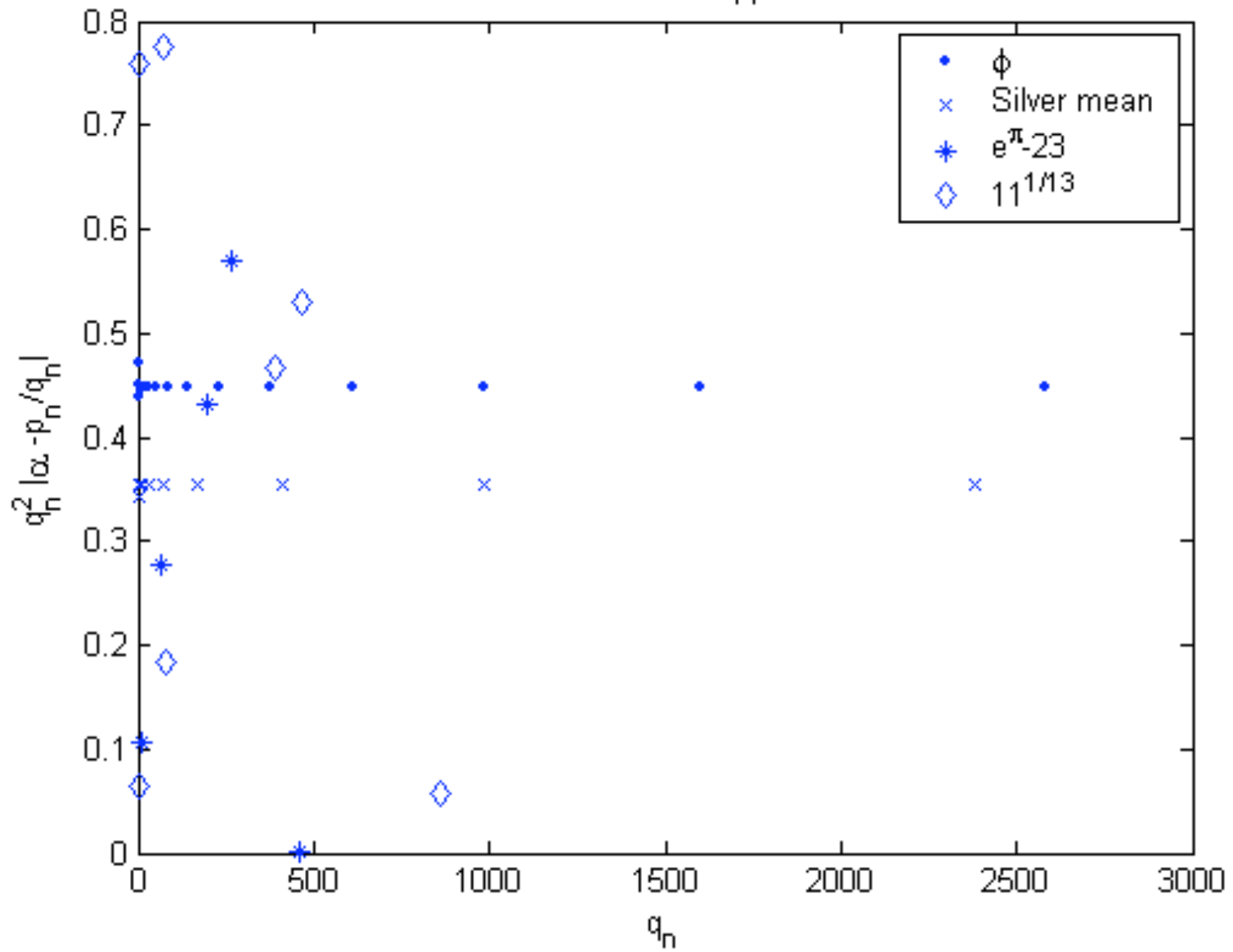



Human Tendencies

It is argued that ϕ occurs in many aspects of human culture and aesthetics:

- Architecture
- Art
- Music
- Religion
- Attractiveness



Architecture

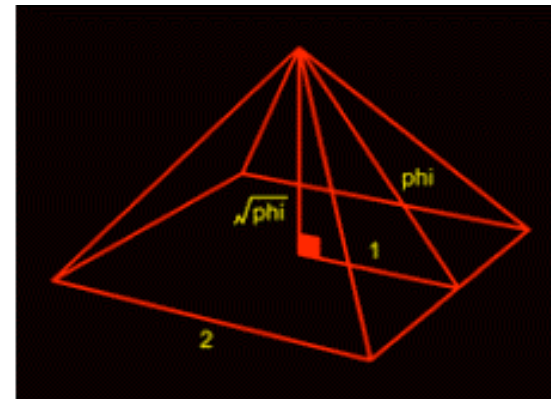
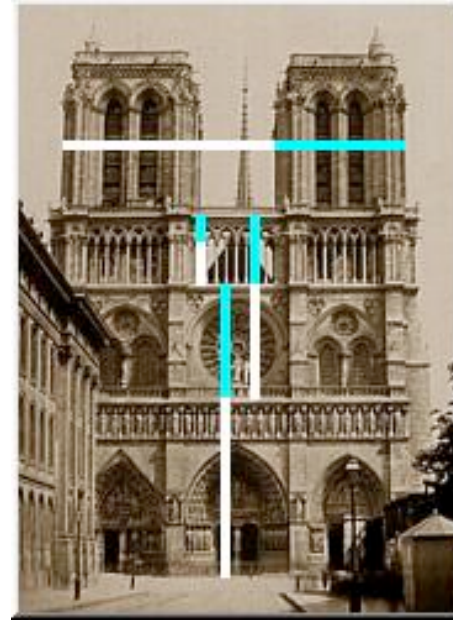
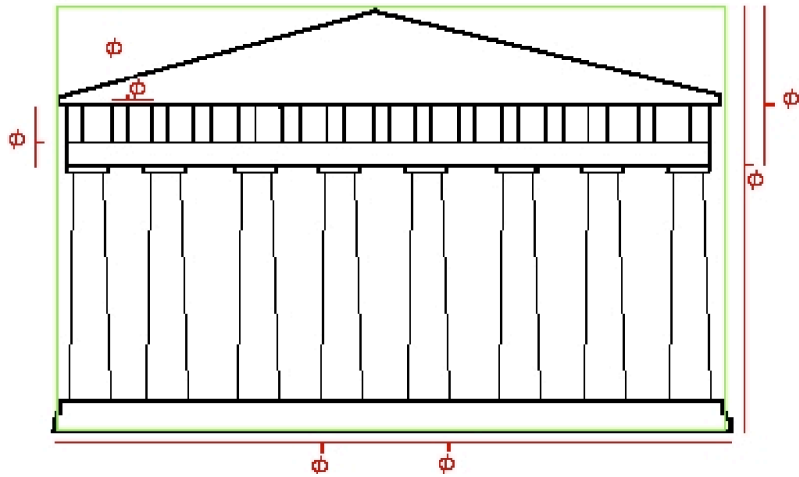



Art

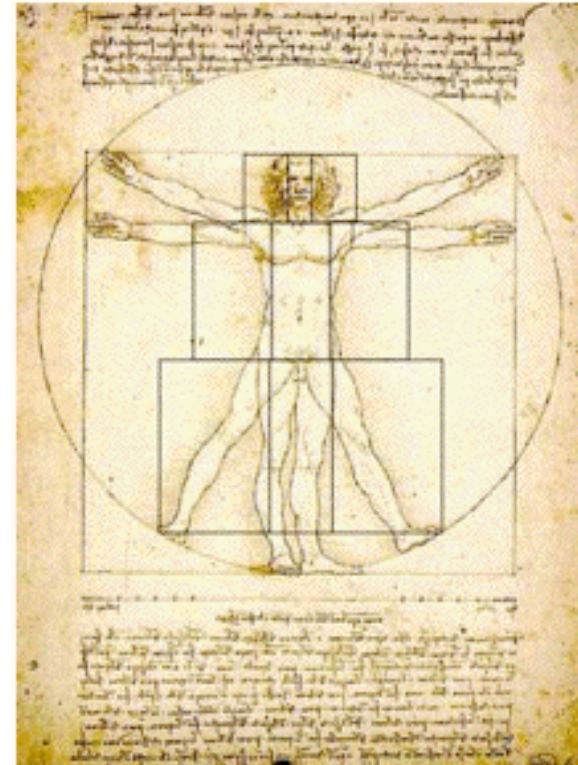
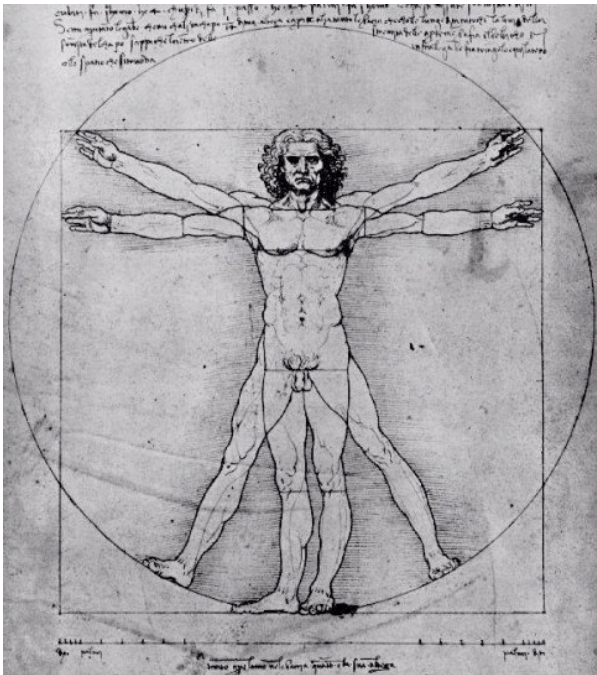

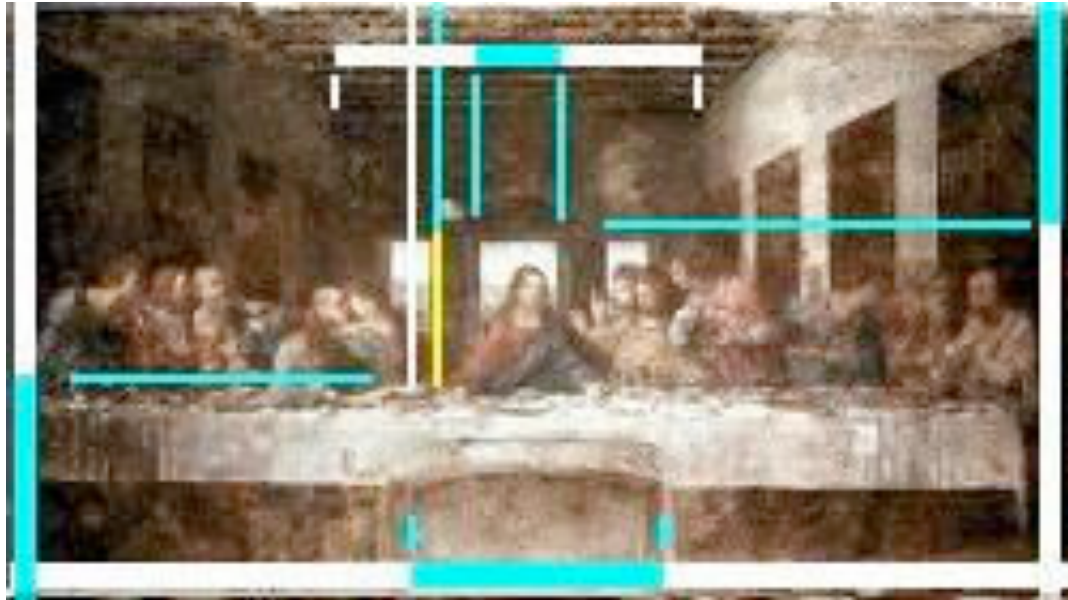



Music

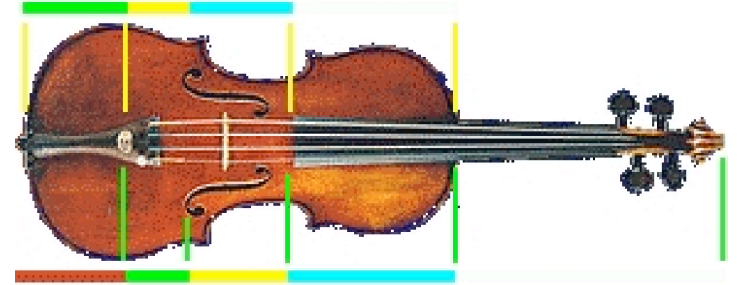

13 notes in
one octave

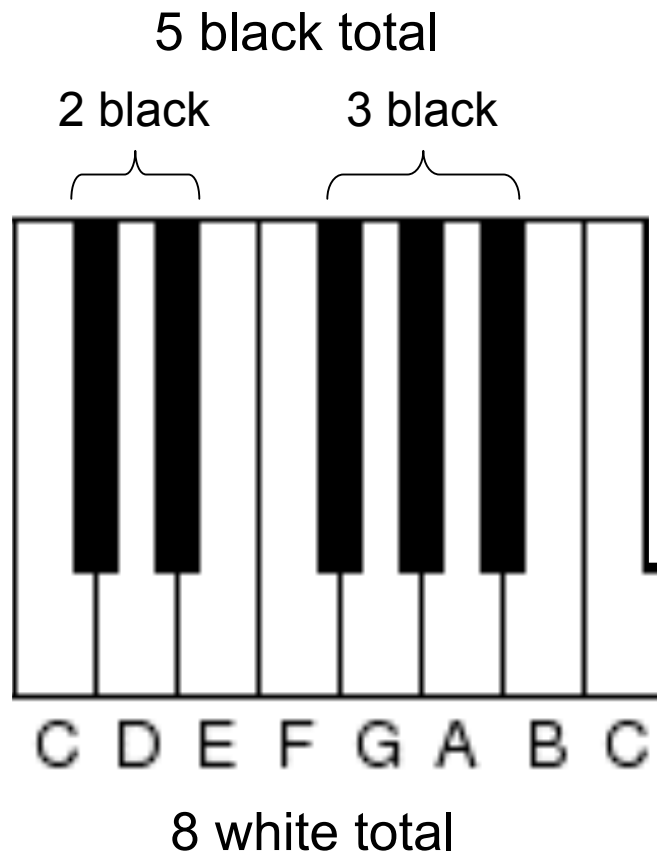

Religion

In Exodus 25:10, God commands Moses to build the Ark of the Covenant, in which to hold His Covenant with the Israelites, the Ten Commandments, saying, "Have them make a chest of acacia wood- two and a half cubits long, a cubit and a half wide, and a cubit and a half high."

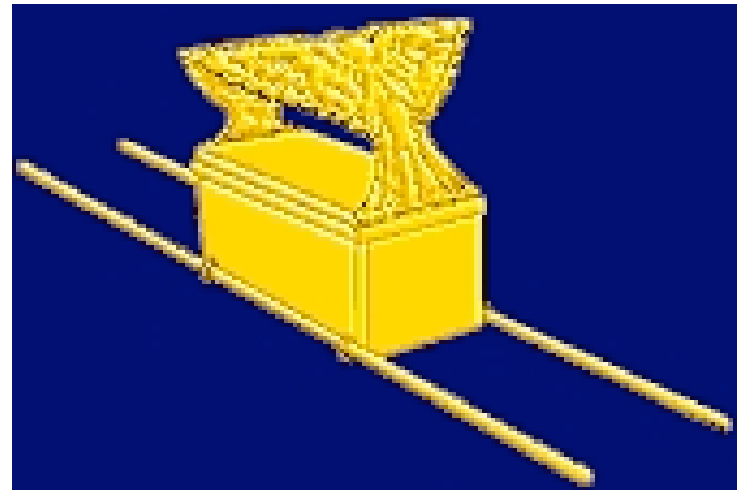

In Genesis 6:15, God commands Noah to build an ark saying,
"And this is the fashion which thou shalt make it of: The length of the ark shall be three hundred cubits, the breadth of it fifty cubits, and the height of it thirty cubits."



Attractiveness

Why was George Clooney chosen as People Magazine's "Sexiest Man Alive" in 1997?





Miscellaneous

- Credit/ID cards
- Television screens



Conclusions

- ϕ -bonacci is a lot of fun mathematically.
- ϕ -bonacci is very pretty.
- ϕ -bonacci is very optimal.
- ϕ -bonacci has snuck into our daily lives.